

Illus Illumination

Indoor Lighting

2024 Catalogue



BEYOND LIGHT..
TO THE LAST DETAILS!

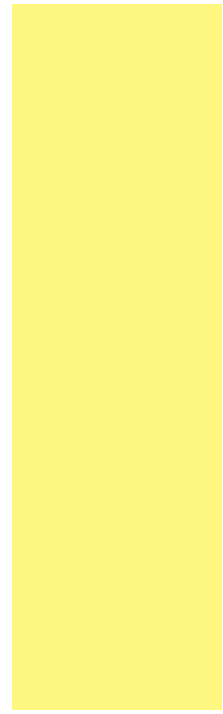

We strive to be
the leader in the industry
and the world's most
respected lighting solution
provider.

ILLUS Lighting

ILLUS dedicates itself to provide human oriented architectural lighting solution and products for indoor and outdoor applications. A truly innovative company, ILLUS has always been at the forefront of professional office lighting since inception. Since then ILLUS continues developing innovative, custom lighting solutions that meet extremely exacting requirements in terms of ergonomics, economic efficiency and environmental compatibility and also deliver aesthetic added value to our customers. Our customers will always find that our solutions reflect the requirements satisfying a broad range of customer needs for every lighting application ILLUS is a brand that helps revealing the beauty around you where it constitutes of products and solutions designed with care and attention to detail giving professional quality products.

Our goal has always been to offer our customers a first-class product backed by unparalleled service, focused on solving our clients' illumination challenges.

Our Vision

In ILLUS every detail created with enthusiasm constantly evolving technology to simplify the life of people. We consistently innovate and devote to decrease power consumption to ease the burden of earth. Light is essential for people's life quality and wellbeing, we care for every situation people need artificial light whenever light serves. ILLUS lighting is beyond light, to the last details.

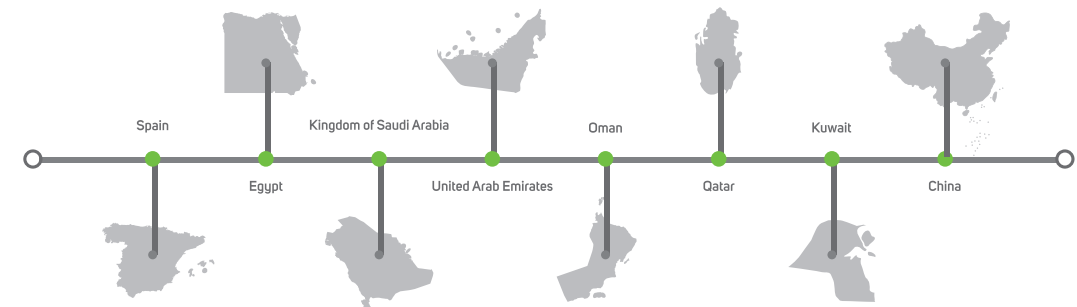

Where to find us

Kingdom of Saudi Arabia-Head Office

📍 3533 Al Kharj Rd, Al Aziziyah, Riyadh 14511
<https://maps.app.goo.gl/TRgDmL4efaDRzWWL8>

China – illus

📍 Star Alliance, No.68 Zhongxing Avenue, Guzhen, Zhongshan,Guangdong, China
<https://maps.app.goo.gl/cJJefWvYRyfzAQjq8>

Spain – illus

📍 46970 Alaquàs, Valencia, Spain
<https://goo.gl/maps/C5DejH52sP17L2Nv9>

UAE – Build Station

📍 75 6th St - Al Quoz - Dubai - United Arab Emirates
<https://goo.gl/maps/LCTSSYSqEB2mcAbA8>

Qatar – Build Station

📍 Zone 43, Street 340, Salwa Rd, Doha, Qatar
<https://maps.app.goo.gl/hQY8PbFDPbXKYiqJ6>

Oman – Build Station

📍 18 November Street 411 Muscat, Al Aziba, 130, Oman
<https://goo.gl/maps/6tJLBVdhiVPvUE1w7>

Kuwait –Lighting Stores

📍 No 4, Opposite the city center entrance, 142 8 St, Shuwaikh Industrial, Kuwait
Lighting Stores - Google Maps

Egypt -illus

📍 13 El Obour Blgds. Salah Salem – Masr El-Gedida - Cairo
30° 04'40.0"N 31° 18'36.7"E - Google Maps



R&D and Manufacturing

Manufacturing

ILLUS has two directly-operated production bases in Yangzhou covering an area of 25,000 square meters and 300 staffs. The production bases contain over 30 hi-speed automatic encapsulation lines, 15 automatic SMD and applied welding lines, 5 automatic extrusion lines and 6 automatic luminaire production lines, characterizing a complete production process for LED strip inclusive of LED encapsulation, hi-speed SMT, automatic welding and full series of water resistance with average monthly production capacity of LED strips reaching up to 1.5 million meters. Besides, ILLUS modernized manufacturing factory to achieve a complete production process for linear luminaire inclusive of precision machining, automatic assembly, color spraying and free customization with average monthly production capacity reaching up to 120,000 strips in order to assure customers of high-quality, super cost-effective products and rapid delivery.

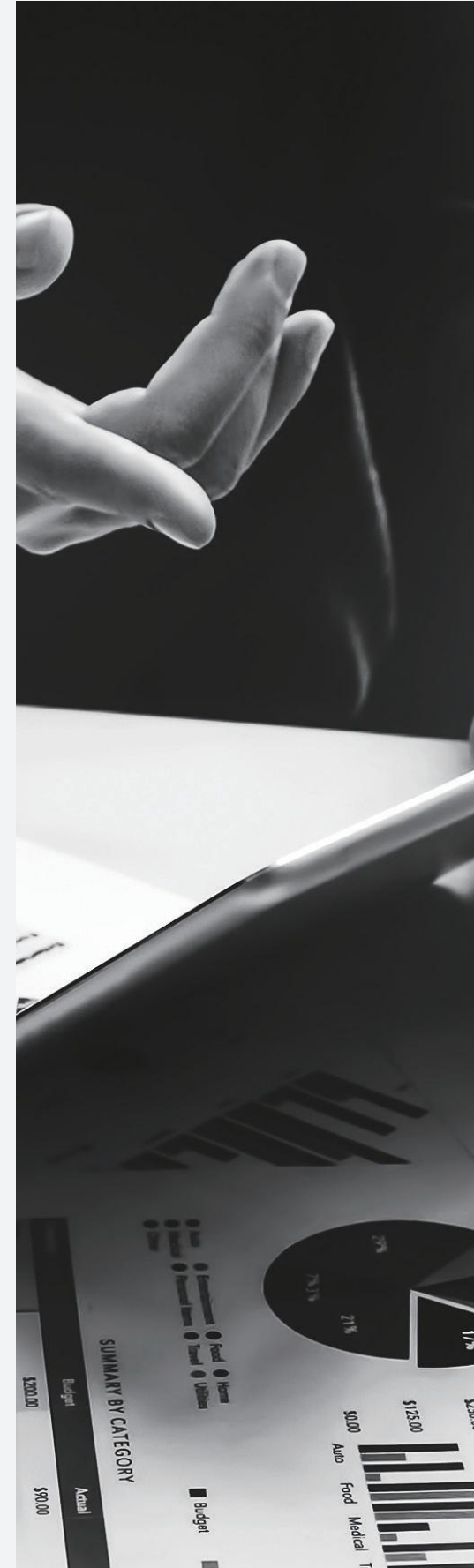

R&D

ILLUS has established a R&D expert team composed of over 50 core technicians, a majority of which graduated from top-rated universities and are proficient in such fields as optics, technique, material science, electrics, thermal physics, intelligent control and industrial design with more than 10years R&D experience and technical know-how in linear lighting.



Laboratory & Inspection

Laboratory of ILLUS, covering an area of 460 square meters, was outfitted with 48 sets of equipment which was distributed as per safety zone, EMC zone, photoelectric zone, IP water resistance zone, aging zone and product reliability zone. Inspection covers products inclusive of LED strip, neon strip, linear luminaire, power supply and related accessories, with inspection standard ranging from safety, EMC, performance to product reliability. Testing reports can be tracked all the way from product design evaluation period to type approval period to guarantee quality of products.



Patent

ILLUS strives to R&D in product and technology. So far, it has gained 3 invention patents and nearly 100 utility model patents and appearance patents.

Contents

LED Magnetic Series

■ LED Magnetic Track Linear Light (Black Version)	4-8
■ LED Flood Track Luminaire	9-10
■ LED Adjustable Magnetic Track Linear Light (Black Version)	11-16
■ LED Adjustable Flood Track Luminaire	17-18
■ LED Magnetic Track Spot Light (Black Version)	19-22
■ LED Magnetic Track Pendant Light (Black Version)	23-26
■ LED Magnetic Track Linear Light (White Version)	27-32
■ LED Adjustable Magnetic Track Linear Light (White Version)	33-36
■ LED Magnetic Track Spot Light (White Version)	38-44
■ LED Magnetic Lights	48-68

LED Recessed & Surface Mounted Ceiling Luminaire

■ IP65 Downlight	72-77
■ SMD	78-79
■ SMD CCT	80-81
■ Economic SMD With PMMA Cover	82-83
■ SMD+Reflector	86-87
■ Plastic DOB Downlight	88-89
■ Mini Downlight	90-93
■ LED Recessed Ceiling Luminaire	94-97

LED Track & Track Rail Accessories

■ Track Light Luminaire	102-111
■ LED Track Mounted Luminaire	112-117
■ Track Mounted Luminaire - Pendant	118-119
■ LED Recessed Linear Luminaire	120-123
■ LED Recessed Linear Luminaire-Corner	124-133
■ LED Pendant Linear Luminaire	134-143
■ LED Pendant Linear Luminaire-Corner	144-153
■ Track	156-169

LED Lamp

■ GU10 Lamp	172-179
■ LED Decorative Lamp	180-187
■ Flying Lamp	188-189
■ LED Smart Lamp	190-195
■ LED Non-Directional Lamp	196-201
■ LED Filament Lamp	202-205
■ LED Filament E27 Lamp	206-217
■ GX53	218-219
■ LED AR111	220-225
■ LED 50 Module (GU10)	226-232
■ LED 35 Module (MR11)	234-236
■ LED Filament Lamp (PIR Sensor)	238-239
■ LED Filament Lamp (Microwave Sensor)	240
■ LED T8 Glass Tube Light	242-245

Accessories

■ Indoor Connector	246-252
--------------------	---------

Frames/Housing

■ Frame	256-327
■ Gypsum Frame	328-330
■ Surface Mounted Luminaire-Wall	331-334

BEYOND LIGHT..
TO THE LAST DETAILS!

Indoor Lighting

- LED Magnetic Series
- LED Recessed & Surface Mounted Ceiling
- LED Track & Track Rail Accessories
- LED Lamp
- Accessories
- Frames/Housing



LED Magnetic Series

- LED Magnetic Track Linear Light (Black Version)
- LED Flood Track Luminaire
- LED Adjustable Magnetic Track Linear Light (Black Version)
- LED Adjustable Flood Track Luminaire
- LED Magnetic Track Spot Light (Black Version)
- LED Magnetic Track Pendant Light (Black Version)
- LED Magnetic Track Linear Light (White Version)
- LED Adjustable Magnetic Track Linear Light (White Version)
- LED Magnetic Track Spot Light (White Version)
- LED Magnetic Lights



LED Magnetic Track Linear Light (Black Version)

Areas of Application

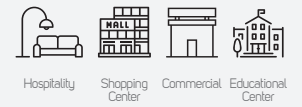

Rhythmic Joy

Technical Operating & Electrical Data

Input Voltage & Frequency	DC48V, 50/60Hz
IP Ratings	IP20
Body Material	Aluminum
CRI	90
Body Color	Sandy Black
Beam Angle	30°
Mounting Type	Surface Mounted
Life Span	30000h

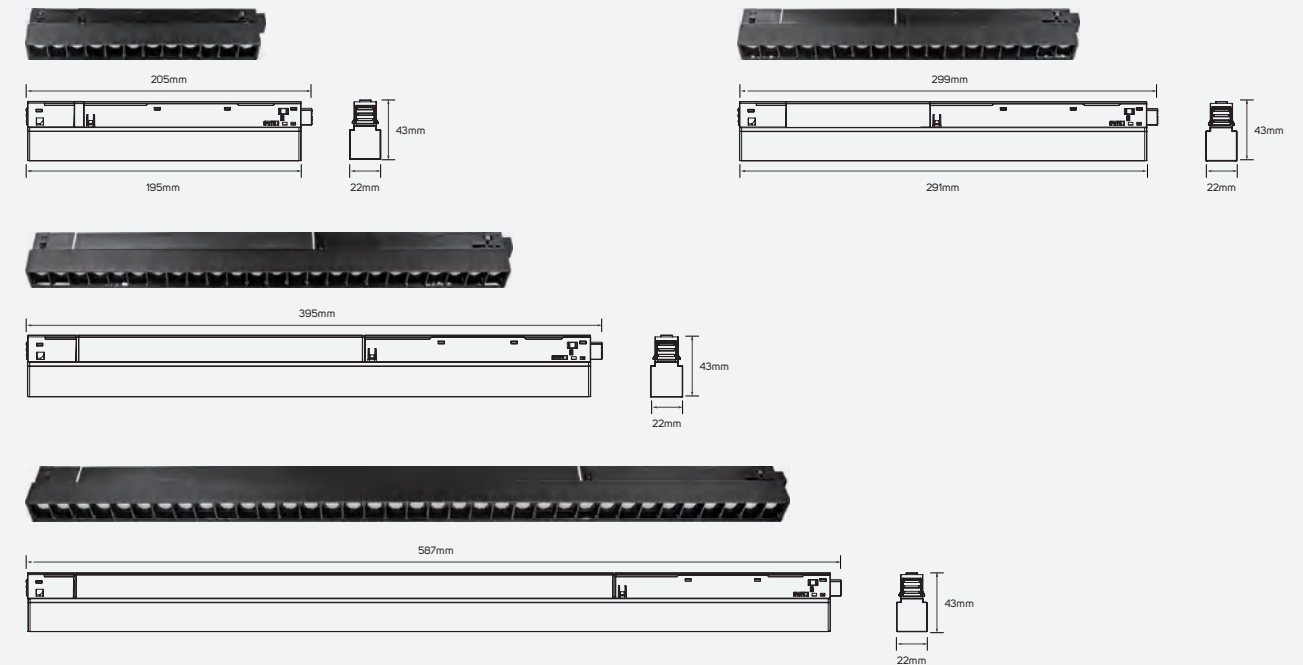

LED Magnetic Track Linear Light (Black Version)

PRODUCT INFORMATION

- Modern looking, neat luminaire offering comfortable, good quality lighting and can also work as a design element.
- Ideal lighting in the non-working areas of professional spaces such as offices, educational institutes, and also the welcoming areas and entrances of retail spaces.
- ILLUS LED MAGNETIC TRACK LINEAR Light gives the customer the flexibility to choose between 8 models based on their specific need with lumen package from 750 lm to 2250 lm.

BENEFITS

- Clean and uniform light.
- Multiple application use.
- Easy to install and maintain.

FEATURES

- High CRI>90.
- Efficacy up to 98 lm/w.
- Long life span 30,000 hrs.
- Operating voltage DC48 V.
- Non – dimmable.

Family Product List

Code No.	Model No.	Power	Lumen	Efficacy	CCT
● 613629	ILS9W36DMTL930WW01	8.5W	750lm	88.24lm/W	3000K
● 613630	ILS9W36DMTL940NW01	8.5W	800lm	94.12lm/W	4000K
● 613631	ILS15W36DMTL930WW01	14.5W	1300lm	89.66lm/W	3000K
● 613632	ILS15W36DMTL940NW01	14.5W	1370lm	94.48lm/W	4000K
● 613633	ILS20W36DMTL930WW01	20W	1650lm	82.50lm/W	3000K
● 613634	ILS20W36DMTL940NW01	20W	1750lm	87.50lm/W	4000K
● 613635	ILS24W110DMTL930WW01	23W	2050lm	89.13lm/W	3000K
● 613636	ILS24W110DMTL940NW01	23W	2250lm	97.83lm/W	4000K

Recessed Magnetic Track Rail

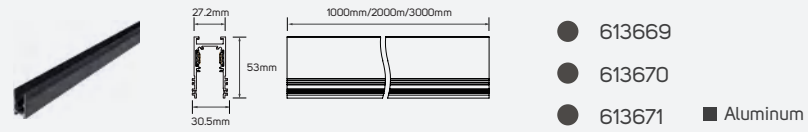

Pendant Magnetic Track Rail

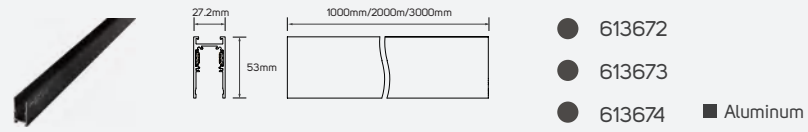

48V Magnetic Driver

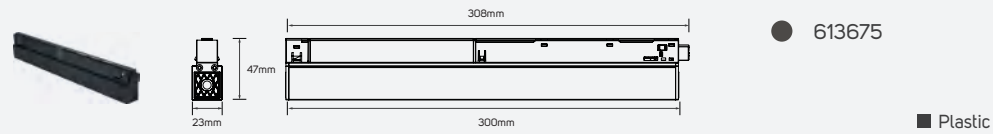

Recessed Horizontal Corner

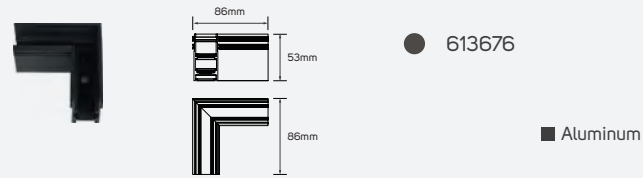

Recessed Inside Corner

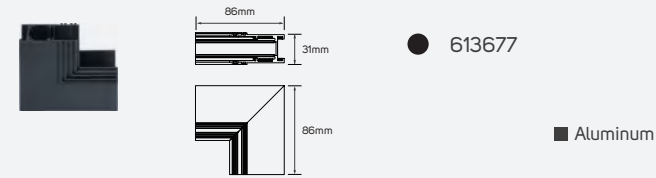

Surface Mounted Horizontal Corner

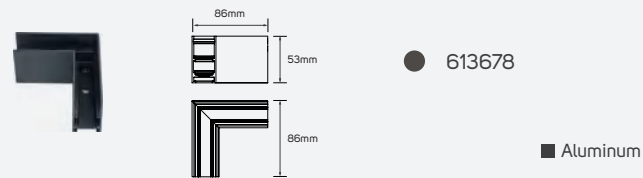

Surface Mounted Inside Corner

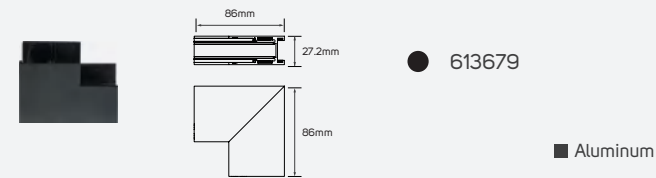

Flexible Corner Conductive Module

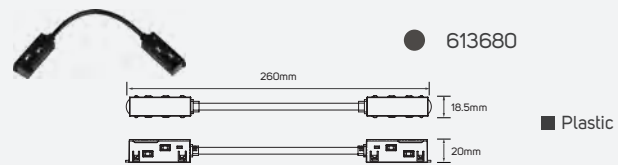

Direct Corner Conductive Module

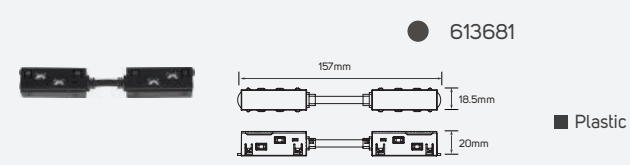

Cable Wire

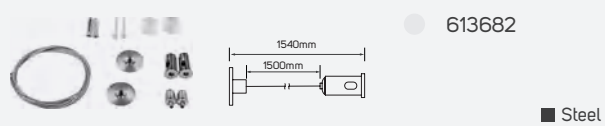

Cable Wire

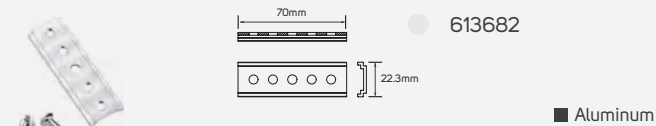

LED Magnetic Track Linear Light (Black Version)

Rhythmic Joy

Technical Operating & Electrical Data

Input Voltage & Frequency	DC48V, 50/60Hz
IP Ratings	IP20
Body Material	Aluminum
CRI	90
Body Color	Sandy Black
Beam Angle	30°
Mounting Type	Surface Mounted
Life Span	30000h

Areas of Application

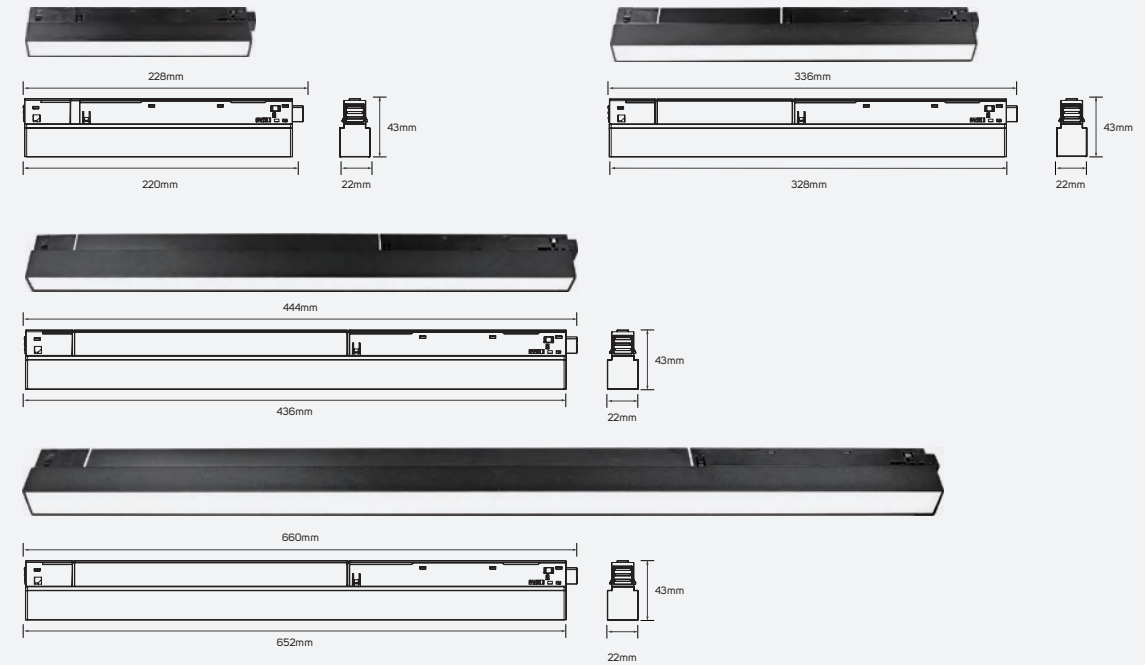
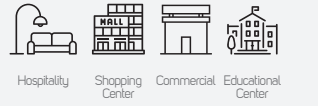

Family Product List

Code No.	Model No.	Power	Lumen	Efficacy	CCT
613643	ILS9W110DMTL930WW03	8W	570lm	71.25lm/W	3000K
613644	ILS9W110DMTL940NW03	8W	600lm	75lm/W	4000K
613645	ILS15W110DMTL930WW03	15W	1110lm	74lm/W	3000K
613646	ILS15W110DMTL940NW03	15W	1170lm	78lm/W	4000K
613647	ILS20W110DMTL930WW03	21W	1600lm	76.19lm/W	3000K
613648	ILS20W110DMTL940NW03	21W	1700lm	80.95lm/W	4000K
613649	ILS24W110DMTL930WW03	24W	1750lm	72.92lm/W	3000K
613650	ILS24W110DMTL940NW03	24W	1900lm	79.17lm/W	4000K

Recessed Magnetic Track Rail

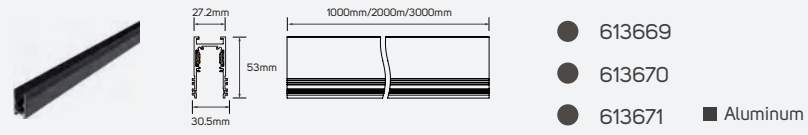

Pendant Magnetic Track Rail

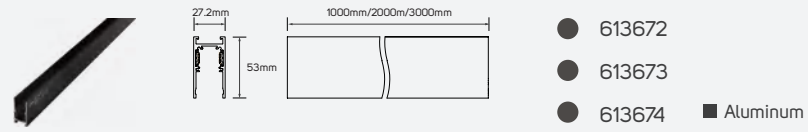

48V Magnetic Driver

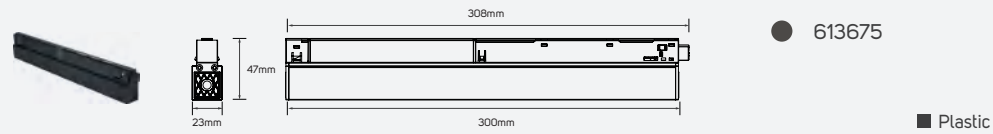

Recessed Horizontal Corner

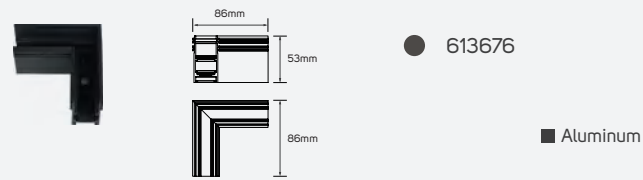

Recessed Inside Corner

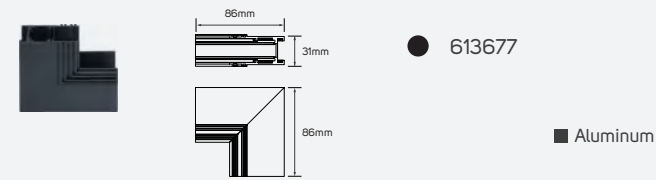

Surface Mounted Horizontal Corner

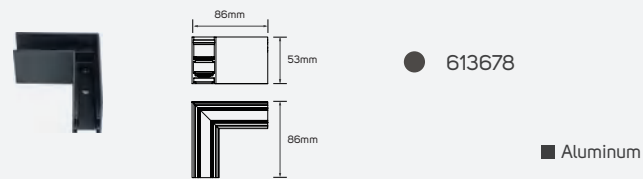

Surface Mounted Inside Corner

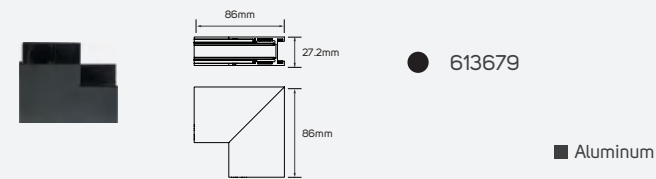

Flexible Corner Conductive Module

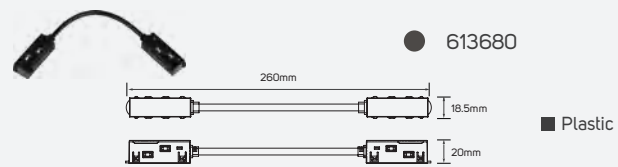

Direct Corner Conductive Module

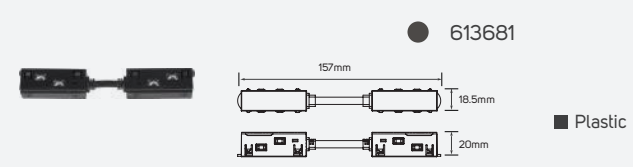

Cable Wire

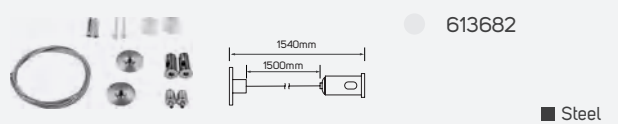

Cable Wire

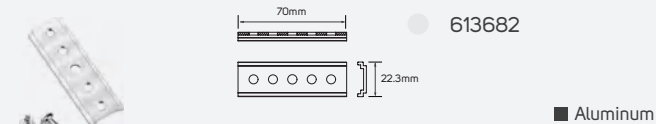

Rhythmic Joy

Technical Operating & Electrical Data

Input Voltage & Frequency	AC220-240V , 50/60Hz
IP Ratings	IP20
Body Material	Aluminum
CRI	95
Body Color	Black
Beam Angle	90°
Life Span	30000h

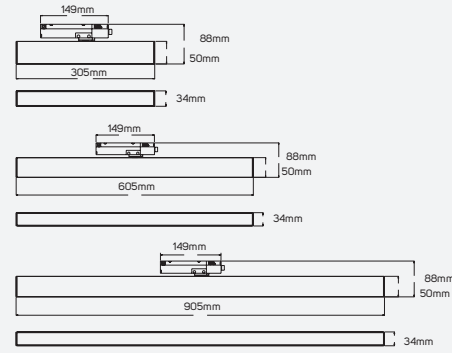

Areas of Application

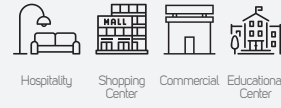

Family Product List

Code No.	Model No.	Power	Lumen	Efficacy	CCT
● 614383	ILS12FTRKL930WW01	12W	850lm	70.83lm/w	3000K
● 614384	ILS12FTRKL940NW01	12W	900lm	75lm/w	4000K
● 614385	ILS26FTRKL930WW01	26W	1850lm	69.23lm/w	3000K
● 614386	ILS26FTRKL940NW01	26W	1920lm	73.85lm/w	4000K
● 614387	ILS33FTRKL930WW01	33W	2350lm	71.21lm/w	3000K
● 614388	ILS33FTRKL940NW01	33W	2500lm	75.76lmw	4000K





LED Adjustable Magnetic Track Linear Light (Black Version)

Areas of Application

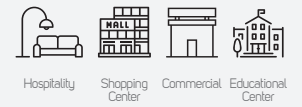

Rhythmic Joy

Technical Operating & Electrical Data

Input Voltage & Frequency	DC48V, 50/60Hz
IP Ratings	IP20
Body Material	Aluminum
CRI	90
Body Color	Sandy Black
Beam Angle	30°
Mounting Type	

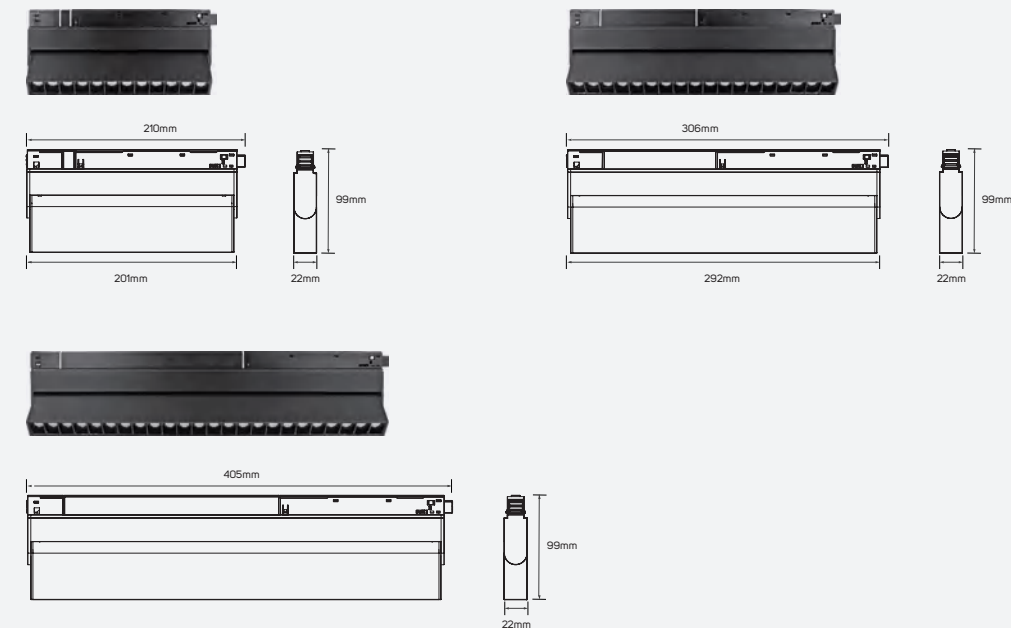

LED Adjustable Magnetic Track Linear Light (Black Version)

PRODUCT INFORMATION

- Modern looking, neat luminaire offering comfortable, good quality lighting and can also work as a design element.
- Ideal lighting in the non-working areas of professional spaces such as offices, educational institutes, and also the welcoming areas and entrances of retail spaces.
- ILLUS LED MAGNETIC TRACK LINEAR Light gives the customer the flexibility to choose between 6 models based on their specific need with lumen package from 750 lm to 1850 lm.

BENEFITS

- Clean and uniform light.
- Multiple application use.
- Easy to install and maintain.

FEATURES

- High CRI>90.
- Efficacy up to 94 lm/w.
- Long life span 30,000 hrs.
- Operating voltage DC48 V.
- Non – dimmable.

Family Product List

Code No.	Model No.	Power	Lumen	Efficacy	CCT
● 613637	ILS9W36DMTL930WW02	8.5W	750lm	88.24lm/W	3000K
● 613638	ILS9W36DMTL940NW02	8.5W	800lm	94.12lm/W	4000K
● 613639	ILS15W36DMTL930WW02	15W	1300lm	86.67lm/W	3000K
● 613640	ILS15W36DMTL940NW02	15W	1370lm	91.33lm/W	4000K
● 613641	ILS20W36DMTL930WW02	20W	1750lm	87.50lm/W	3000K
● 613642	ILS20W36DMTL940NW02	20W	1850lm	92.50lm/W	4000K

Recessed Magnetic Track Rail

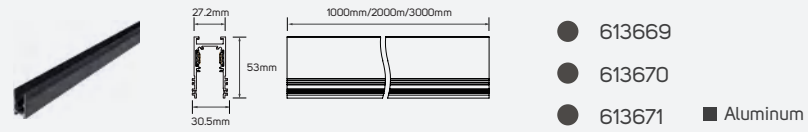

Pendant Magnetic Track Rail

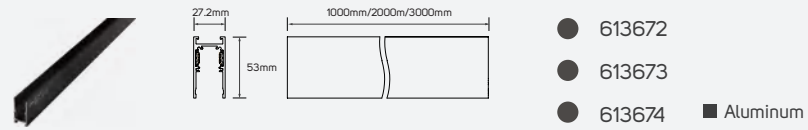

48V Magnetic Driver

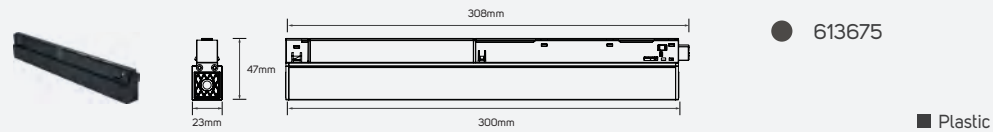

Recessed Horizontal Corner

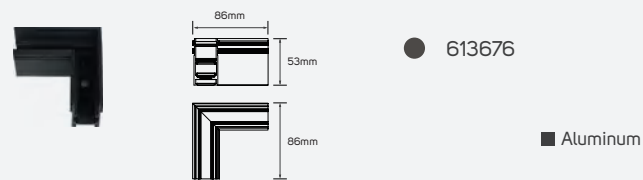

Recessed Inside Corner

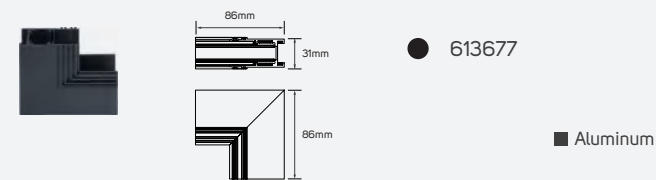

Surface Mounted Horizontal Corner

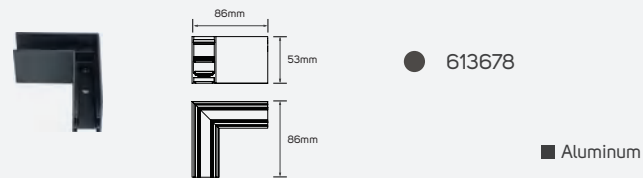

Surface Mounted Inside Corner

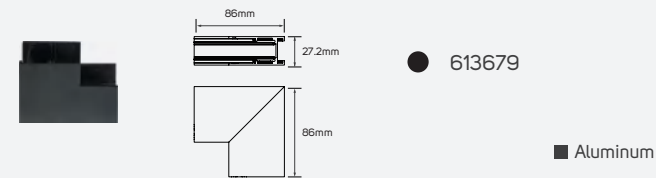

Flexible Corner Conductive Module

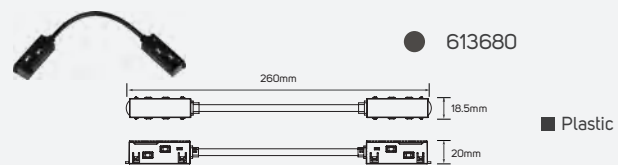

Direct Corner Conductive Module

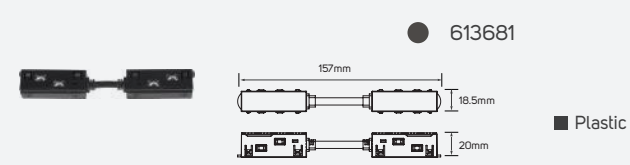

Cable Wire

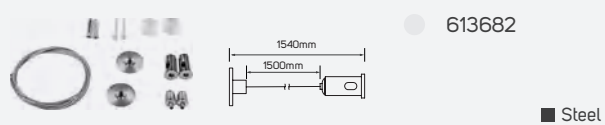

Cable Wire

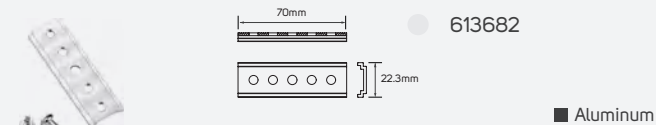

LED Adjustable Magnetic Track Linear Light (Black Version)

Rhythmic Joy

Technical Operating & Electrical Data

Input Voltage & Frequency	DC48V, 50/60Hz
IP Ratings	IP20
Body Material	Aluminum
CRI	90
CCT	3000K
Beam Angle	45°
Dimming	Non-Dimmable
Life Span	30000h

Areas of Application

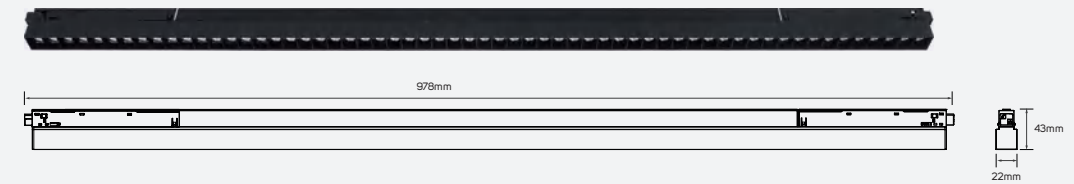
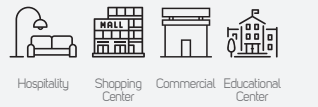

614595



614596

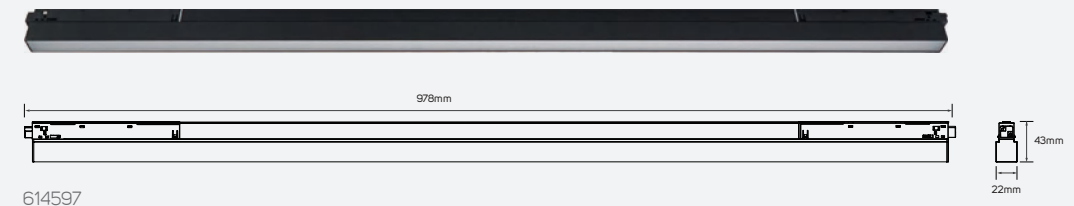

614597

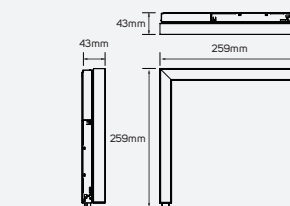
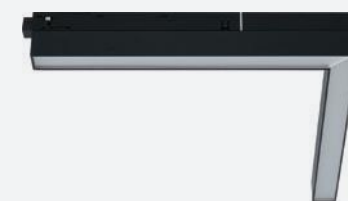

614598

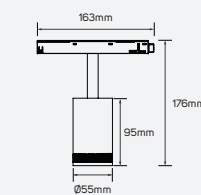

614599

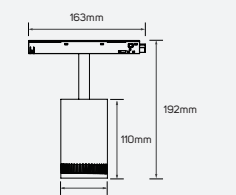

614600

Flexible Conductive Module

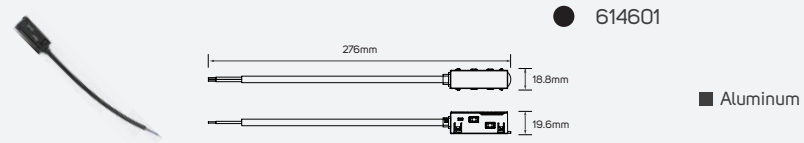

Family Product List

Code No.	Model No.	Body Color	Power	Lumen	Efficacy	Beam Angle
614595	ILS38W28DMLT930WW01	Sandy black	38W	3450lm	90.79lm/W	30°
614596	ILS38W28DAML930WW01	Sandy black	38W	3450lm	90.79lm/W	30°
614597	ILS38W90DFMTL930WW01	Sandy black	38W	2800lm	73.68lm/W	90°
614598	ILS20W110DLMTL930WW01	Sandy black	20W	1500lm	75lm/W	90°
614599	ILS8WZMTL930WW01	Sandy black	8W	750lm	93.75lm/W	15°~55°
614600	ILS16WZMTL930WW01	Sandy black	16W	1500lm	93.75lm/W	15°~55°
614649	ILS38W28DMLT930WW02	Sandy White	38W	3450lm	90.79lm/W	30°
614650	ILS38W28DAML930WW02	Sandy White	38W	3450lm	90.79lm/W	30°
614651	ILS38W90DFMTL930WW02	Sandy White	38W	2800lm	73.68lm/W	90°
614652	ILS20W110DLMTL930WW02	Sandy White	20W	1500lm	75lm/W	90°
614653	ILS8WZMTL930WW02	Sandy White	8W	750lm	93.75lm/W	15°~55°
614654	ILS16WZMTL930WW02	Sandy White	16W	1500lm	93.75lm/W	15°~55°



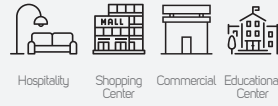

Rhythmic Joy

Technical Operating & Electrical Data

Input Voltage & Frequency	AC220-240V , 50/60Hz
IP Ratings	IP20
Body Material	Aluminum
CRI	95
Body Color	Black
Beam Angle	30°
Life Span	30000h

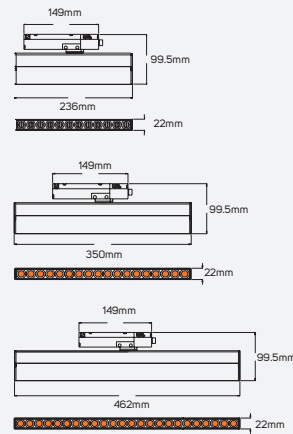
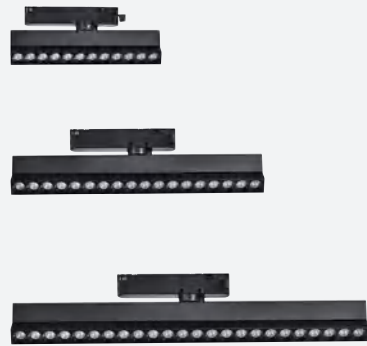

Family Product List

Code No.	Model No.	Power	Lumen	Efficacy	CCT
● 614389	ILS12AGTRKL930WW01	12W	1050lm	87.50lm/w	3000K
● 614390	ILS12AGTRKL940NW01	12W	1100lm	91.67lm/w	4000K
● 614391	ILS19AGTRKL930WW01	19W	1650lm	86.84lm/w	3000K
● 614392	ILS19AGTRKL940NW01	19W	1720lm	90.53lm/w	4000K
● 614393	ILS23AGTRKL930WW01	23W	2100lm	91.30lm/w	3000K
● 614394	ILS23AGTRKL940NW01	23W	2200lm	95.65lm/w	4000K

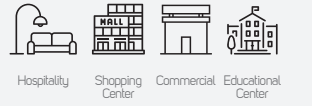

Rhythmic Joy

Technical Operating & Electrical Data

Input Voltage & Frequency	AC220-240V , 50/60Hz
IP Ratings	IP20
Body Material	Aluminum
CRI	95
Body Color	Black
Beam Angle	90°
Life Span	30000h

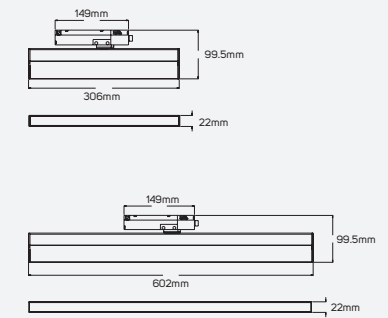

Family Product List

Code No.	Model No.	Power	Lumen	Efficacy	CCT
● 614395	ILS12AFTRKL930WW01	12W	850lm	70.83lm/w	3000K
● 614396	ILS12AFTRKL940NW01	12W	900lm	75lm/w	4000K
● 614397	ILS22AFTRKL930WW01	22W	1550lm	70.45lm/w	3000K
● 614398	ILS22AFTRKL940NW01	22W	1650lm	75lm/w	4000K



LED Magnetic Track Spot Light (Black Version)

Planet

Technical Operating & Electrical Data

Input Voltage & Frequency	DC48V, 50/60Hz
IP Ratings	IP20
Body Material	Aluminum
CRI	90
Body Color	Sandy Black
Beam Angle	24°
Mounting Type	Track Mounted
Life Span	30000h

Areas of Application

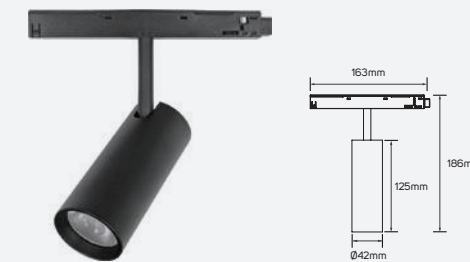
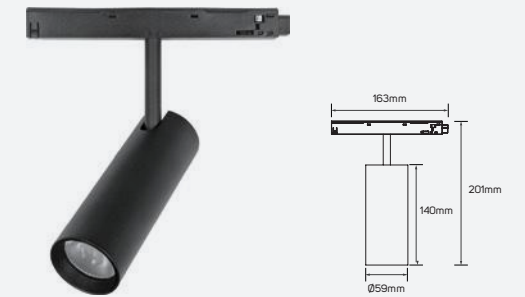
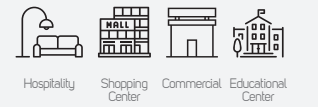

LED Magnetic Track Spot Light (Black Version)

PRODUCT INFORMATION

- Modern looking, neat luminaire offering comfortable, good quality lighting and can also work as a design element.
- Ideal lighting in the non-working areas of professional spaces such as offices, educational institutes, and also the welcoming areas and entrances of retail spaces.
- ILLUS LED MAGNETIC TRACK SPOT Light gives the customer the flexibility to choose between 6 models based on their specific need with lumen package from 800 lm to 1450 lm.

BENEFITS

- Clean and uniform light.
- Multiple application use.
- Easy to install and maintain.

FEATURES

- High CRI>90.
- Efficacy up to 106 lm/w.
- Long life span 30,000 hrs.
- Operating voltage DC48 V.
- Non – dimmable.

Family Product List

Code No.	Model No.	Power	Lumen	Efficacy	CCT
● 613651	ILS9W24DMTSL930WW01	8W	800lm	100lm/W	3000K
● 613652	ILS9W24DMTSL940NW01	8W	850lm	106.25lm/W	4000K
● 613653	ILS12W24DMTSL930WW01	12.5W	1150lm	92lm/W	3000K
● 613654	ILS12W24DMTSL940NW01	12.5W	1220lm	97.60lm/W	4000K
● 613655	ILS18W24DMTSL930WW01	16W	1350lm	84.38lm/W	3000K
● 613656	ILS18W24DMTSL940NW01	16W	1450lm	90.63lm/W	4000K

Recessed Magnetic Track Rail

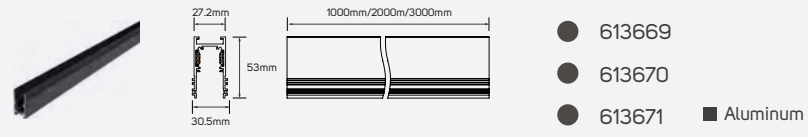

Pendant Magnetic Track Rail

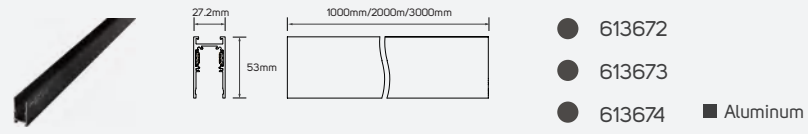

48V Magnetic Driver

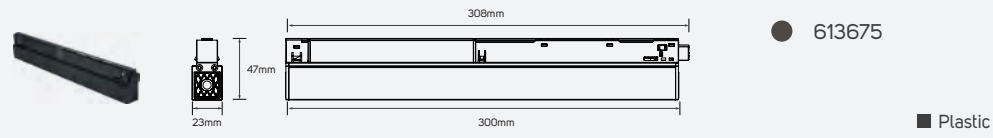

Recessed Horizontal Corner

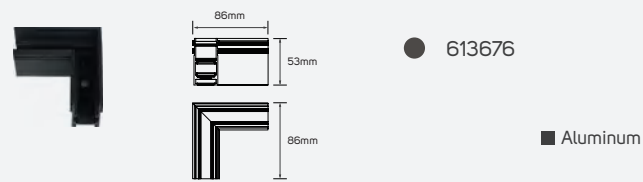

Recessed Inside Corner

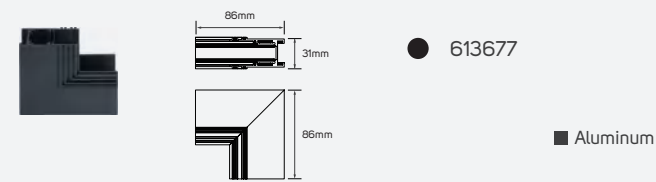

Surface Mounted Horizontal Corner

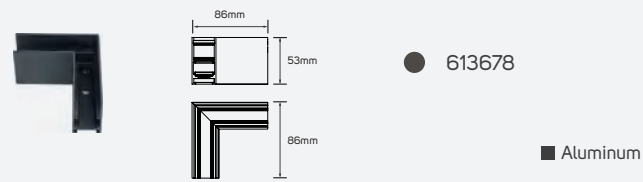

Surface Mounted Inside Corner

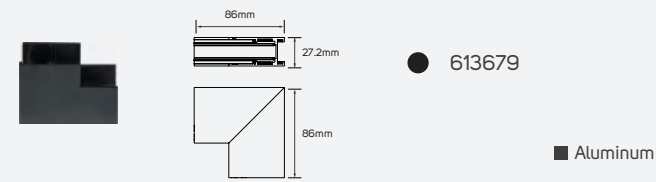

Flexible Corner Conductive Module

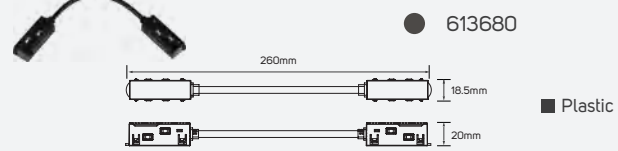

Direct Corner Conductive Module

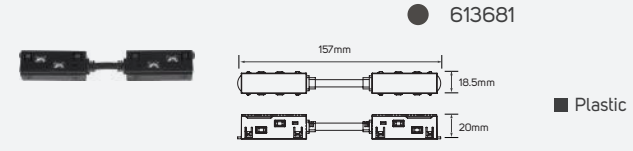

Cable Wire

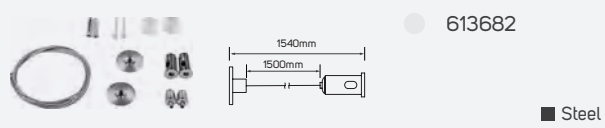

Cable Wire

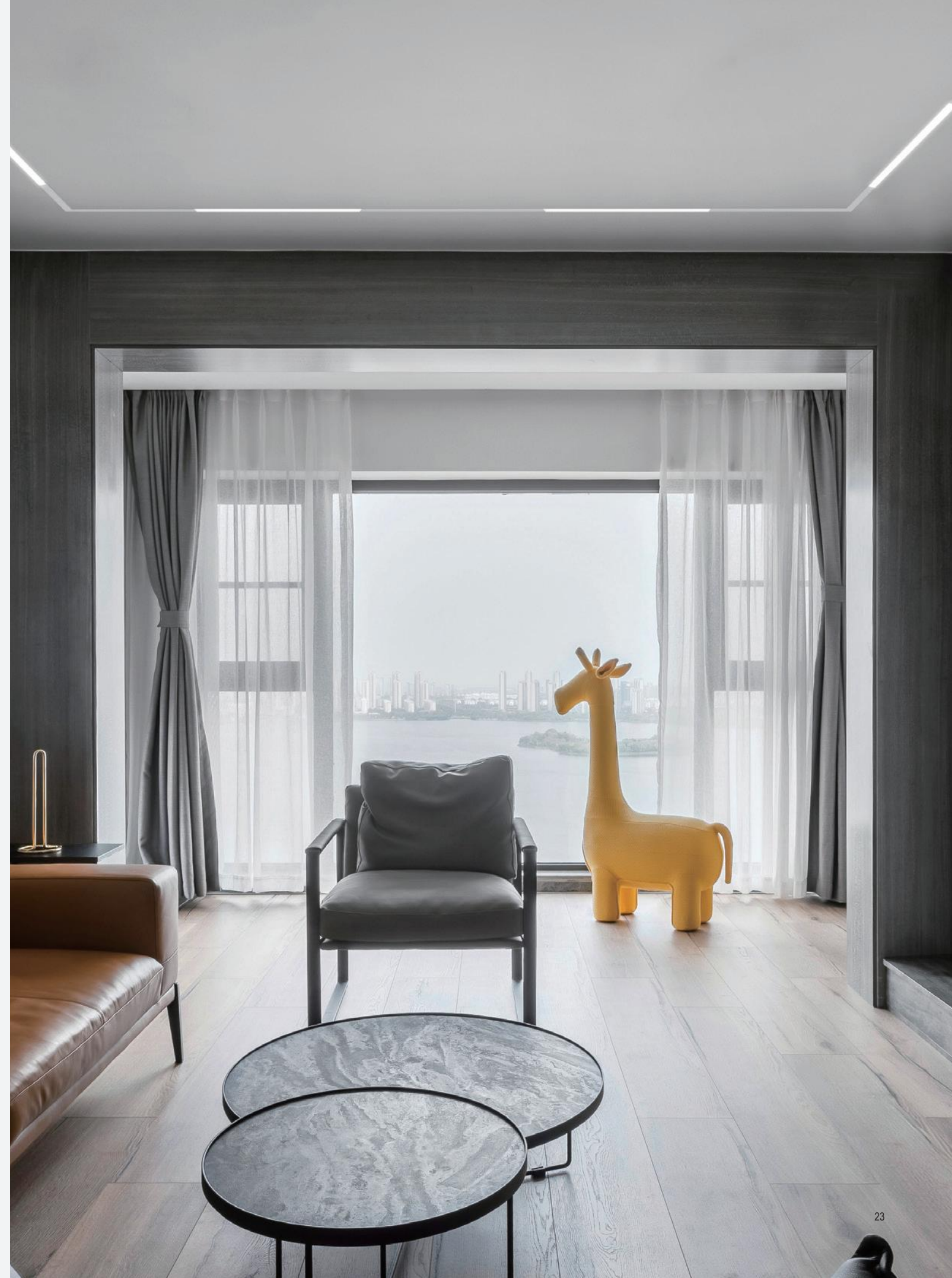
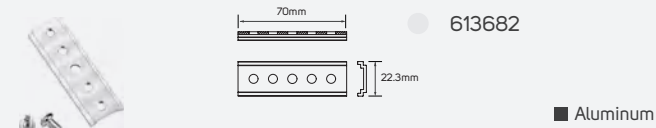



LED Magnetic Track Pendant Light (Black Version)

PRODUCT INFORMATION

- Modern looking, neat luminaire offering comfortable, good quality lighting and can also work as a design element.
- Ideal lighting in the non-working areas of professional spaces such as offices, educational institutes, and also the welcoming areas and entrances of retail spaces.
- ILLUS LED MAGNETIC TRACK SPOT Light gives the customer the flexibility to choose between 12 models based on their specific need with lumen package from 370 lm to 1050 lm.

BENEFITS

- Clean and uniform light.
- Multiple application use.
- Easy to install and maintain.

FEATURES

- High CRI>90.
- Efficacy up to 106 lm/w.
- Long life span 30,000 hrs.
- Operating voltage DC48 V.
- Non - dimmable.

LED Magnetic Track Pendant Light (Black Version)

Glorya

Technical Operating & Electrical Data

Input Voltage & Frequency	DC48V, 50/60Hz
IP Ratings	IP20
Body Material	Aluminum+Industrial Plastic
CRI	90
Body Color	Sandy Black
Beam Angle	24°
Mounting Type	Track Mounted
Life Span	30000h

Areas of Application

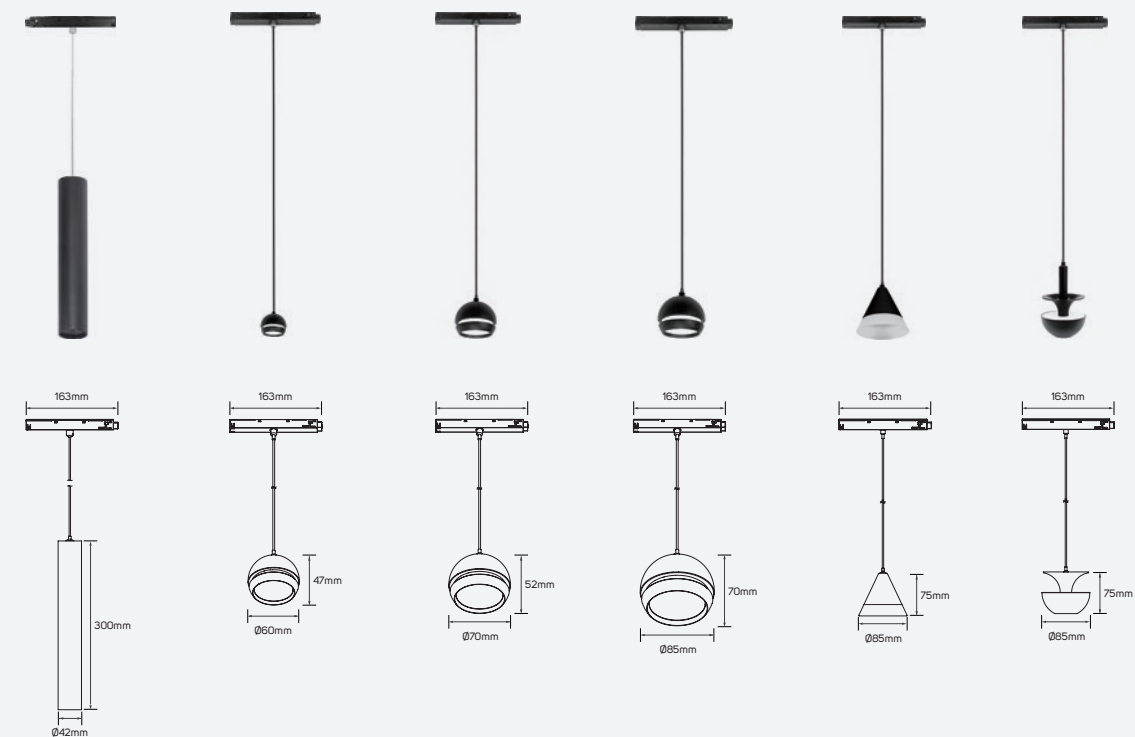

613657 - 613658 613659 - 613660 613661 - 613662 613663 - 613664 613665 - 613666 613667 - 613668

Family Product List

Code No.	Model No.	Power	Lumen	Efficacy	CCT
● 613657	ILS9W24DMTPL930WW01	8.5W	850lm	100lm/W	3000K
● 613658	ILS9W24DMTPL940NW01	8.5W	900lm	105.88lm/W	4000K
● 613659	ILS5W100DMTPL930WW01	5W	450lm	90lm/W	3000K
● 613660	ILS5W100DMTPL940NW01	5W	480lm	96lm/W	4000K
● 613661	ILS7W100DMTPL930WW01	7W	650lm	92.86lm/W	3000K
● 613662	ILS7W100DMTPL940NW01	7W	700lm	100lm/W	4000K
● 613663	ILS12W100DMTPL930WW01	12W	950lm	79.17lm/W	3000K
● 613664	ILS12W100DMTPL940NW01	12W	1050lm	87.50lm/W	4000K
● 613665	ILS5W24DMTPL930WW01	4.5W	370lm	82.22lm/W	3000K
● 613666	ILS5W24DMTPL940NW01	4.5W	450lm	100lm/W	4000K
● 613667	ILS5W24DMTPL930WW02	4.5W	380lm	84.44lm/W	3000K
● 613668	ILS5W24DMTPL940NW02	4.5W	400lm	88.89lm/W	4000K

Recessed Magnetic Track Rail

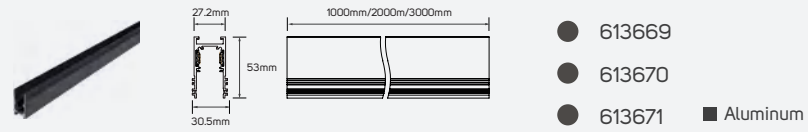

Pendant Magnetic Track Rail

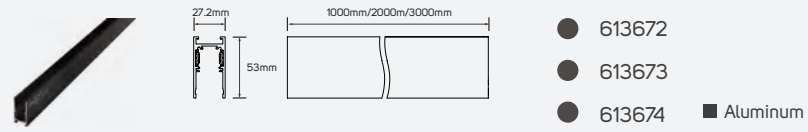

48V Magnetic Driver

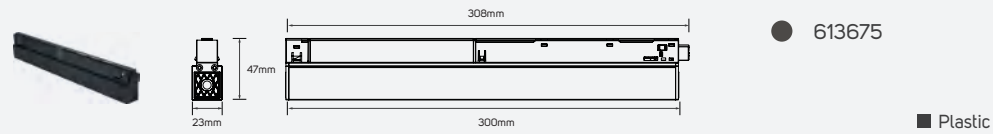

Recessed Horizontal Corner

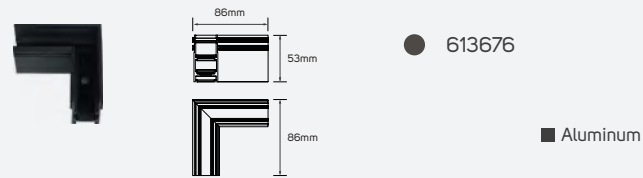

Recessed Inside Corner

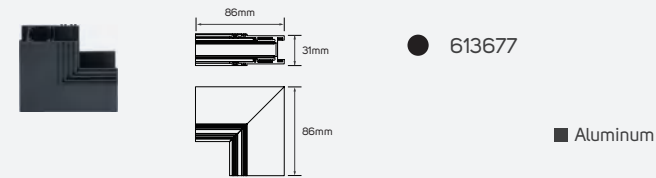

Surface Mounted Horizontal Corner

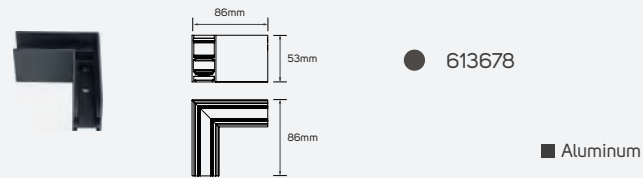

Surface Mounted Inside Corner

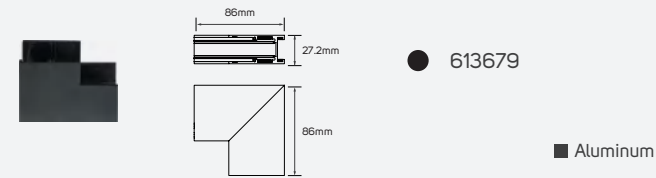

Flexible Corner Conductive Module

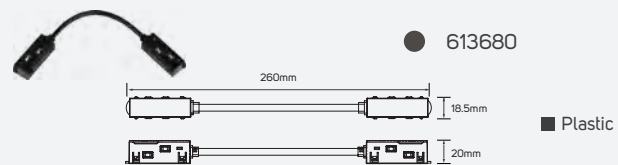

Direct Corner Conductive Module

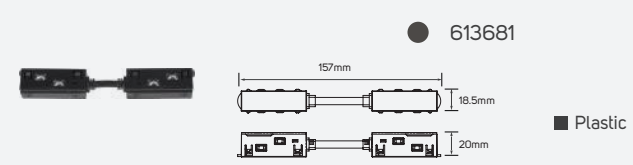

Cable Wire

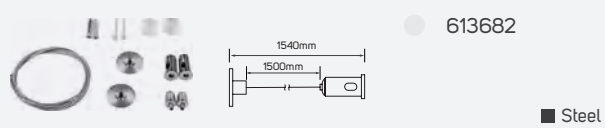

Cable Wire

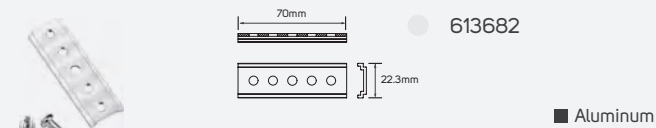



LED Magnetic Track Linear Light (White Version)

Areas of Application

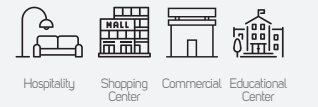

Rhythmic Joy

Technical Operating & Electrical Data

Input Voltage & Frequency	DC48V, 50/60Hz
IP Ratings	IP20
Body Material	Aluminum
CRI	90
Body Color	Sandy White
Beam Angle	30°
Mounting Type	Surface Mounted
Life Span	30000h

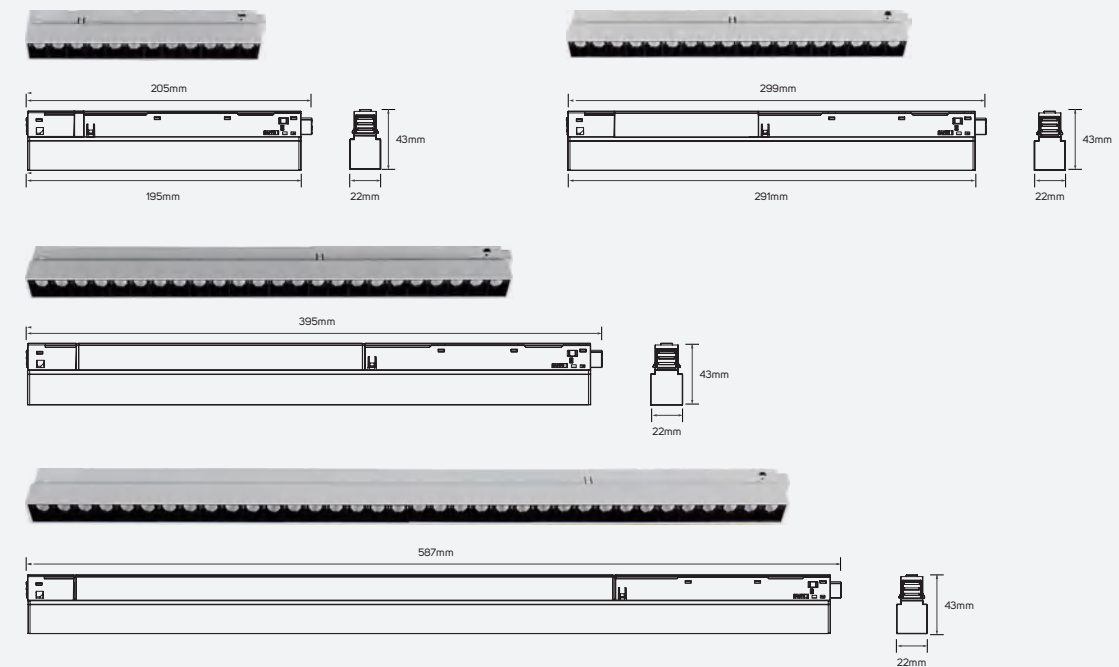

LED Magnetic Track Linear Light (White Version)

PRODUCT INFORMATION

- Modern looking, neat luminaire offering comfortable, good quality lighting and can also work as a design element.
- Ideal lighting in the non-working areas of professional spaces such as offices, educational institutes, and also the welcoming areas and entrances of retail spaces.
- ILLUS LED MAGNETIC TRACK LINEAR Light gives the customer the flexibility to choose between 8 models based on their specific need with lumen package from 750 lm to 2250 lm.

BENEFITS

- Clean and uniform light.
- Multiple application use.
- Easy to install and maintain.

FEATURES

- High CRI>90.
- Efficacy up to 98 lm/w.
- Long life span 30,000 hrs.
- Operating voltage DC48 V.
- Non – dimmable.

Family Product List

Code No.	Model No.	Power	Lumen	Efficacy	CCT
614524	ILS8.5W30DMTL930WWW01	8.5W	750lm	88.24lm/W	3000K
614525	ILS8.5W30DMTL940NWW01	8.5W	800lm	94.12lm/W	4000K
614526	ILS14.5W30DMTL930WWW01	14.5W	1300lm	89.66lm/W	3000K
614527	ILS14.5W30DMTL940NWW01	14.5W	1370lm	94.48lm/W	4000K
614528	ILS20W30DMTL930WWW01	20W	1650lm	82.50lm/W	3000K
614529	ILS20W30DMTL940NWW01	20W	1750lm	87.50lm/W	4000K
614530	ILS23W30DMTL930WWW01	23W	2050lm	89.13lm/W	3000K
614531	ILS23W30DMTL940NWW01	23W	2250lm	97.83lm/W	4000K

Recessed Magnetic Track Rail

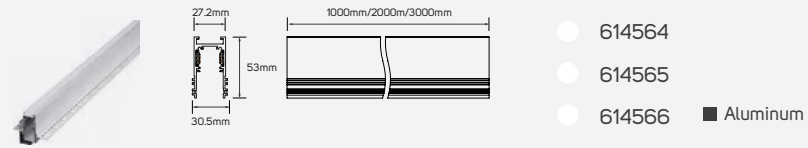

Pendant Magnetic Track Rail

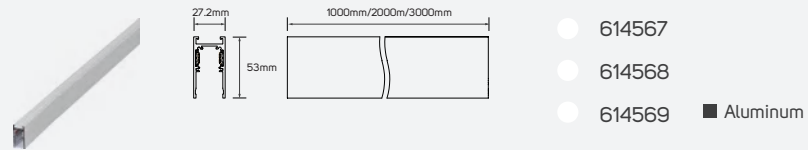

48V Magnetic Driver

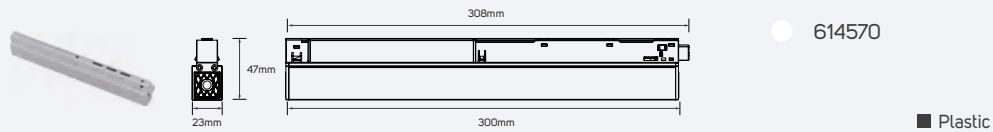

Recessed Horizontal Corner

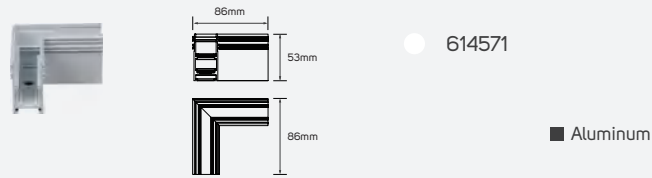

Recessed Inside Corner

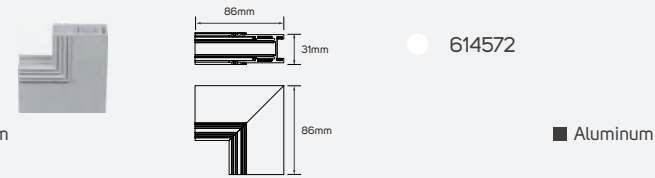

Surface Mounted Horizontal Corner

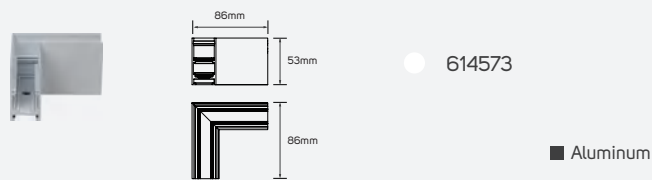

Surface Mounted Inside Corner

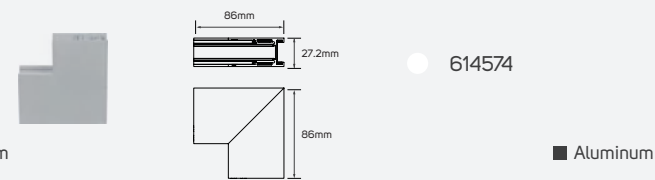

Flexible Corner Conductive Module

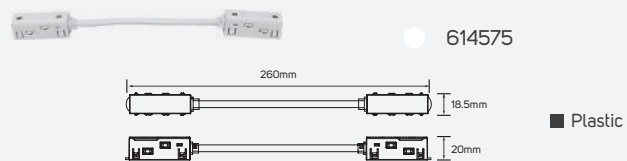

Direct Corner Conductive Module

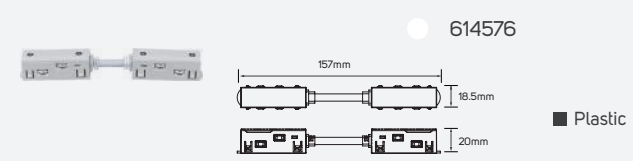

Cable Wire

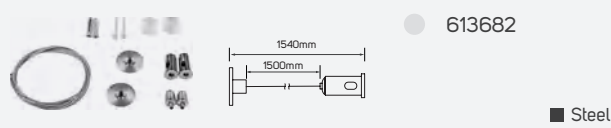

Cable Wire

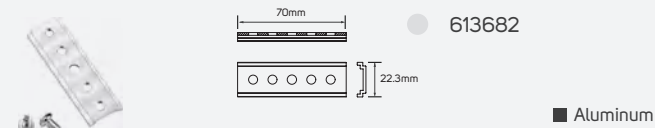

LED Magnetic Track Linear Light (White Version)

Rhythmic Joy

Technical Operating & Electrical Data

Input Voltage & Frequency	DC48V, 50/60Hz
IP Ratings	IP20
Body Material	Aluminum
CRI	90
Body Color	Sandy White
Beam Angle	90°
Mounting Type	Surface Mounted
Life Span	30000h

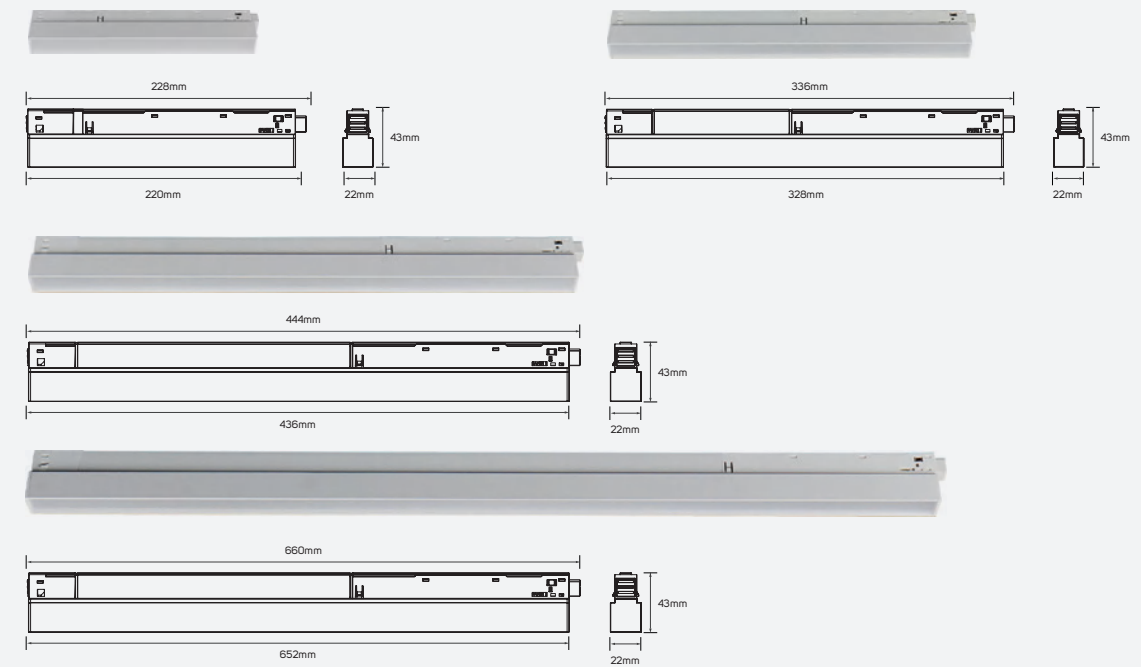

Areas of Application

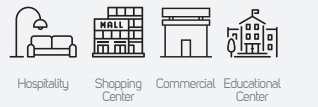

Family Product List

Code No.	Model No.	Power	Lumen	Efficacy	CCT
614538	ILS9W110DMTL930WW03	8W	570lm	71.25lm/W	3000K
614539	ILS9W110DMTL940NW03	8W	600lm	75lm/W	4000K
614540	ILS15W110DMTL930WW03	15W	1110lm	74lm/W	3000K
614541	ILS15W110DMTL940NW03	15W	1170lm	78lm/W	4000K
614542	ILS20W110DMTL930WW03	21W	1600lm	76.19lm/W	3000K
614543	ILS20W110DMTL940NW03	21W	1700lm	80.95lm/W	4000K
614544	ILS24W110DMTL930WW03	24W	1750lm	72.92lm/W	3000K
614545	ILS24W110DMTL940NW03	24W	1900lm	79.17lm/W	4000K

Recessed Magnetic Track Rail

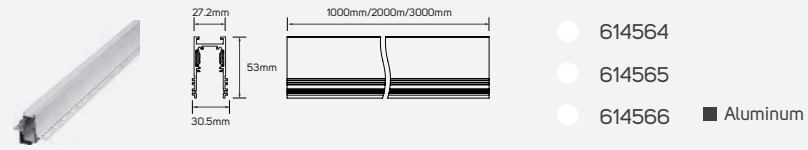

Pendant Magnetic Track Rail

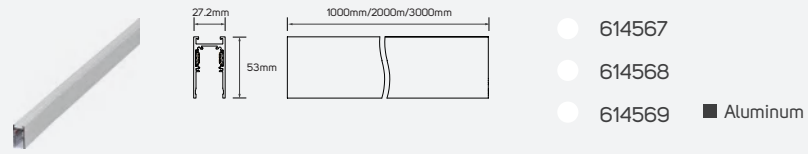

48V Magnetic Driver

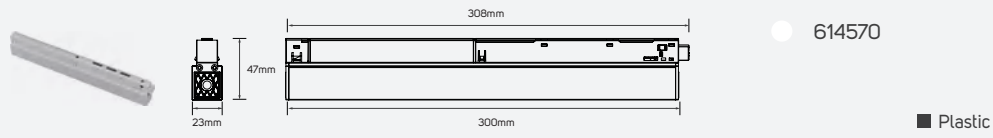

Recessed Horizontal Corner

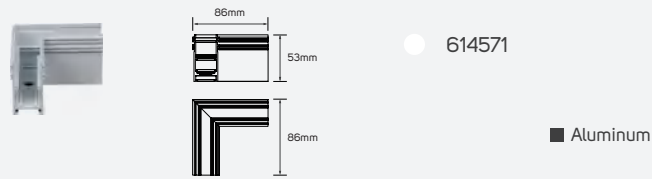

Recessed Inside Corner

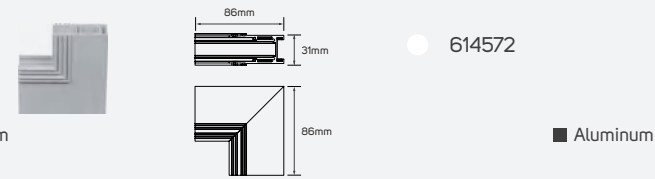

Surface Mounted Horizontal Corner

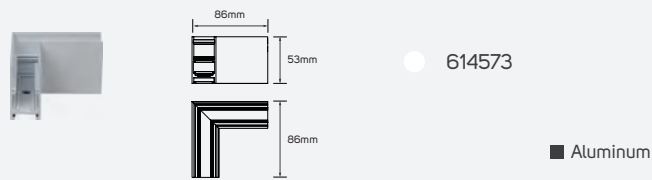

Surface Mounted Inside Corner

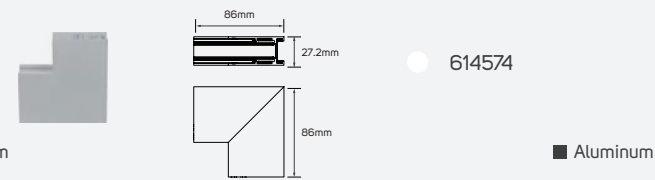

Flexible Corner Conductive Module

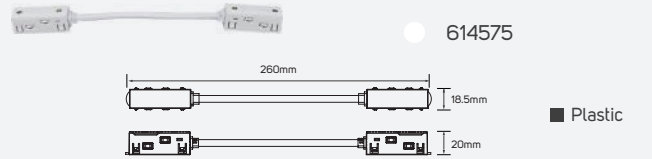

Direct Corner Conductive Module

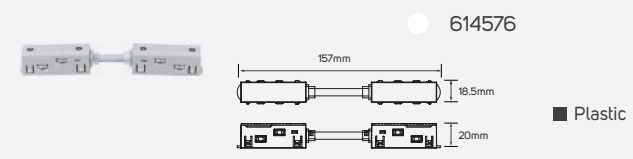

Cable Wire

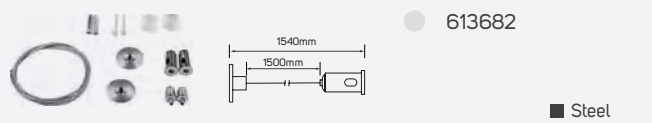

Cable Wire

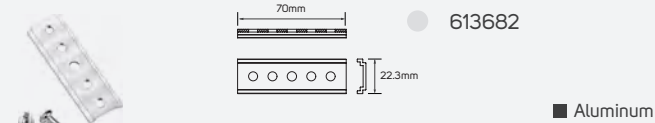



LED Adjustable Magnetic Track Linear Light (White Version)

Rhythmic Joy

Technical Operating & Electrical Data

Input Voltage & Frequency	DC48V, 50/60Hz
IP Ratings	IP20
Body Material	Aluminum
CRI	90
Body Color	Sandy White
Beam Angle	30°
Mounting Type	Surface Mounted
Life Span	30000h

Areas of Application

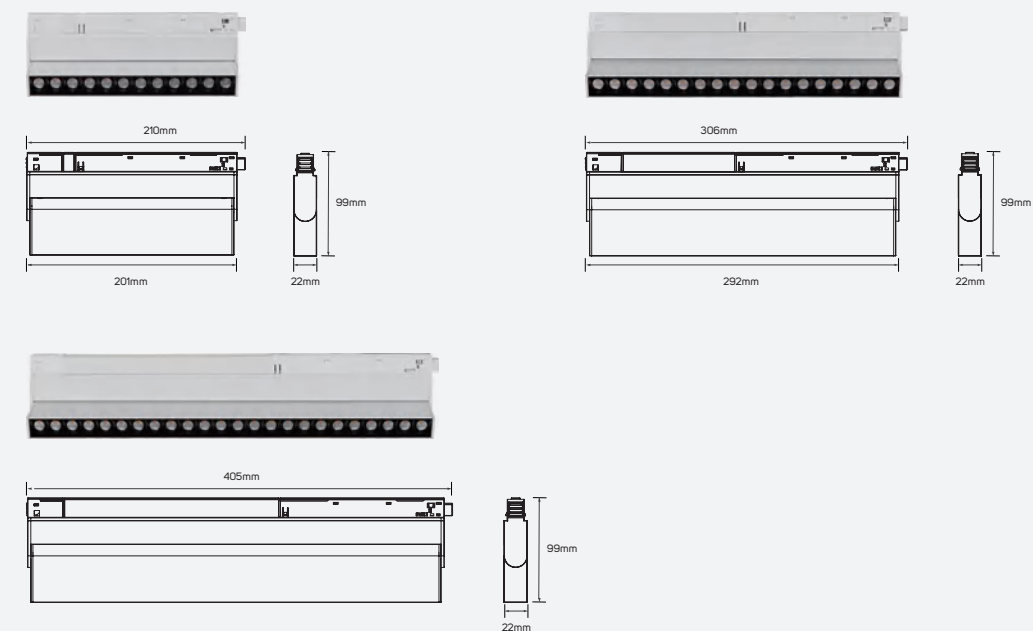
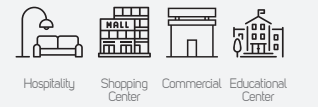

LED Adjustable Magnetic Track Linear Light (White Version)

PRODUCT INFORMATION

- Modern looking, neat luminaire offering comfortable, good quality lighting and can also work as a design element.
- Ideal lighting in the non-working areas of professional spaces such as offices, educational institutes, and also the welcoming areas and entrances of retail spaces.
- ILLUS LED MAGNETIC TRACK LINEAR Light gives the customer the flexibility to choose between 6 models based on their specific need with lumen package from 750 lm to 1850 lm.

BENEFITS

- Clean and uniform light.
- Multiple application use.
- Easy to install and maintain.

FEATURES

- High CRI>90.
- Efficacy up to 94 lm/w.
- Long life span 30,000 hrs.
- Operating voltage DC48 V.
- Non – dimmable.

Family Product List

Code No.	Model No.	Power	Lumen	Efficacy	CCT
614532	ILS8.5W30DMTL930WWW02	8.5W	750lm	88.24lm/W	3000K
614533	ILS8.5W30DMTL940NWW02	8.5W	800lm	94.12lm/W	4000K
614534	ILS15W30DMTL930WWW02	15W	1300lm	86.67lm/W	3000K
614535	ILS15W30DMTL940NWW02	15W	1370lm	91.33lm/W	4000K
614536	ILS20W30DMTL930WWW02	20W	1750lm	87.50lm/W	3000K
614537	ILS20W30DMTL940NWW02	20W	1850lm	92.50lm/W	4000K

Recessed Magnetic Track Rail

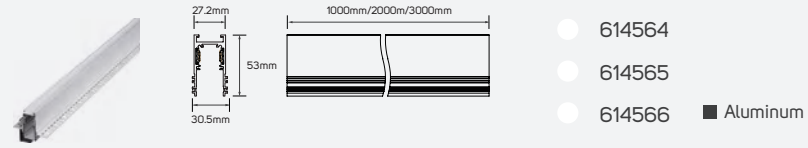

Pendant Magnetic Track Rail

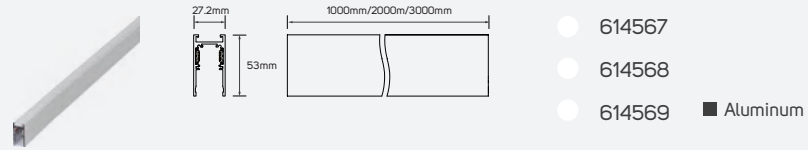

48V Magnetic Driver

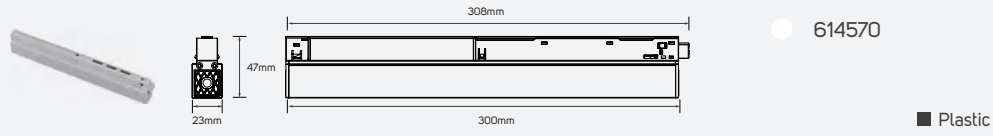

Recessed Horizontal Corner

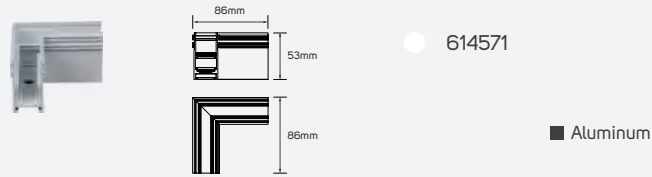

Recessed Inside Corner

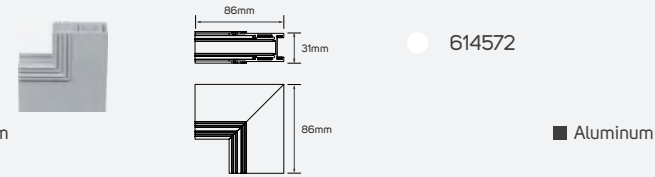

Surface Mounted Horizontal Corner

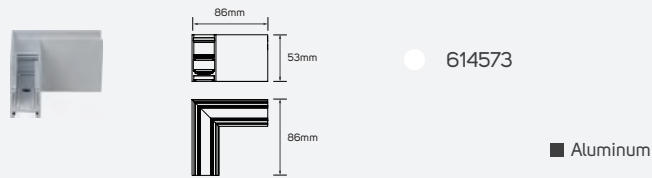

Surface Mounted Inside Corner

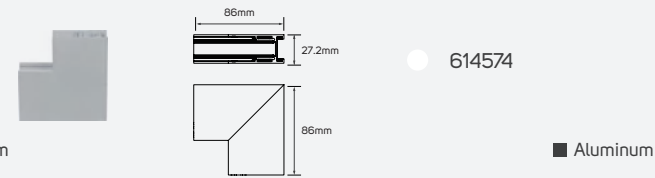

Flexible Corner Conductive Module

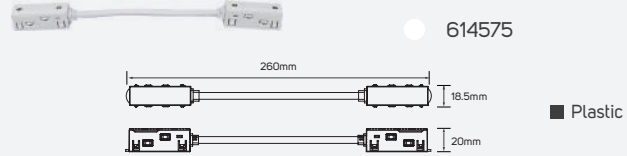

Direct Corner Conductive Module

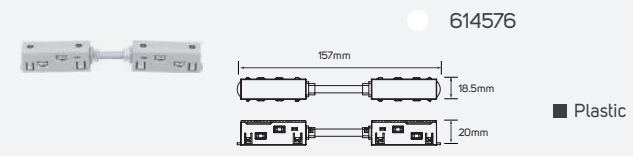

Cable Wire

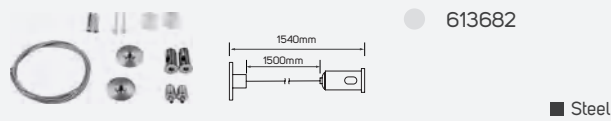

Cable Wire

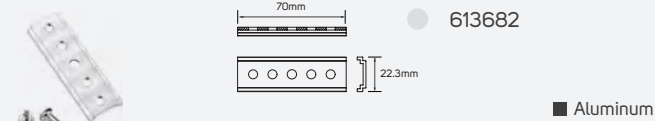



LED Magnetic Track Spot Light (White Version)

Planet

Technical Operating & Electrical Data

Input Voltage & Frequency	DC48V, 50/60Hz
IP Ratings	IP20
Body Material	Aluminum
CRI	90
Body Color	Sandy White
Beam Angle	24°
Mounting Type	Track Mounted
Life Span	30000h

Areas of Application

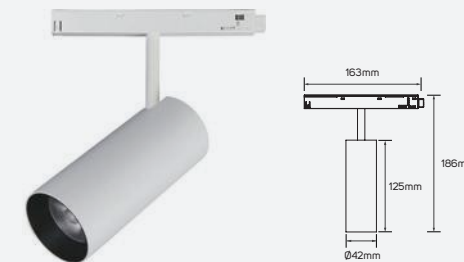
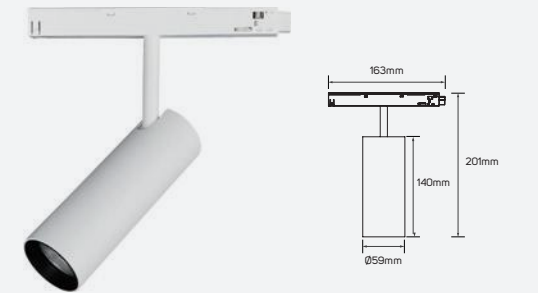
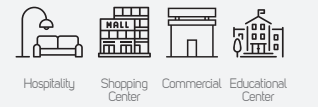

LED Magnetic Track Spot Light (White Version)

PRODUCT INFORMATION

- Modern looking, neat luminaire offering comfortable, good quality lighting and can also work as a design element.
- Ideal lighting in the non-working areas of professional spaces such as offices, educational institutes, and also the welcoming areas and entrances of retail spaces.
- ILLUS LED MAGNETIC TRACK SPOT Light gives the customer the flexibility to choose between 6 models based on their specific need with lumen package from 800 lm to 1450 lm.

BENEFITS

- Clean and uniform light.
- Multiple application use.
- Easy to install and maintain.

FEATURES

- High CRI>90.
- Efficacy up to 106 lm/w.
- Long life span 30,000 hrs.
- Operating voltage DC48 V.
- Non – dimmable.

Family Product List

Code No.	Model No.	Power	Lumen	Efficacy	CCT
614546	ILS8W24DMTSL930WWW01	8W	800lm	100lm/W	3000K
614547	ILS8W24DMTSL940NWW01	8W	850lm	106.25lm/W	4000K
614548	ILS12.5W24DMTSL930WWW01	12.5W	1150lm	92lm/W	3000K
614549	ILS12.5W24DMTSL940NWW01	12.5W	1220lm	97.60lm/W	4000K
614550	ILS16W24DMTSL930WWW01	16W	1350lm	84.38lm/W	3000K
614551	ILS16W24DMTSL940NWW01	16W	1450lm	90.63lm/W	4000K

Recessed Magnetic Track Rail

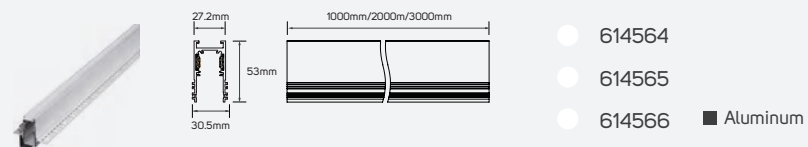

Pendant Magnetic Track Rail

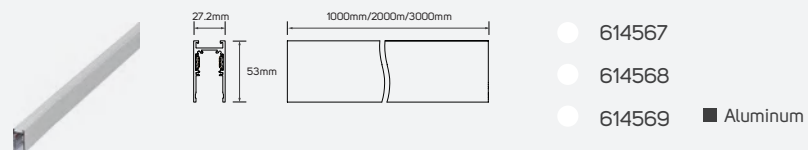

48V Magnetic Driver

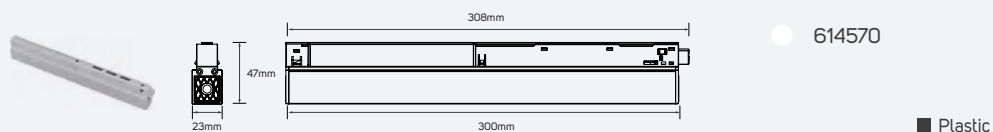

Recessed Horizontal Corner

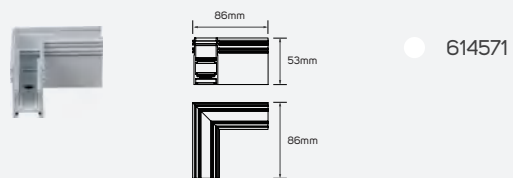

Recessed Inside Corner

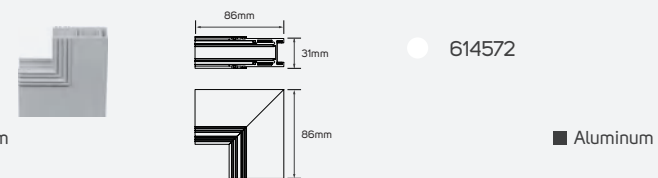

Surface Mounted Horizontal Corner

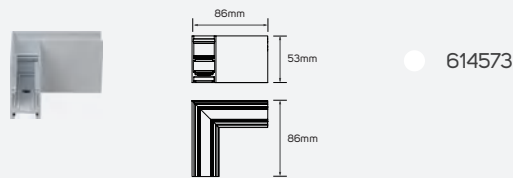

Surface Mounted Inside Corner

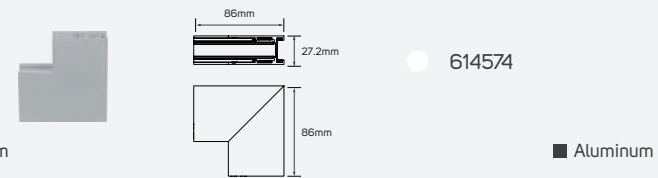

Flexible Corner Conductive Module

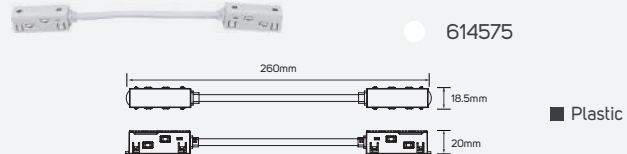

Direct Corner Conductive Module

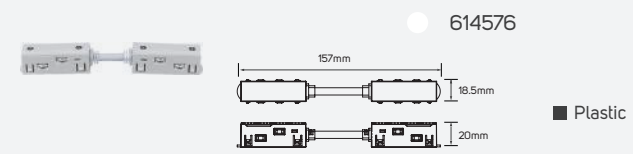

Cable Wire

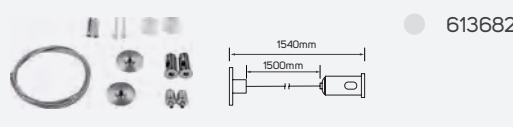

Cable Wire

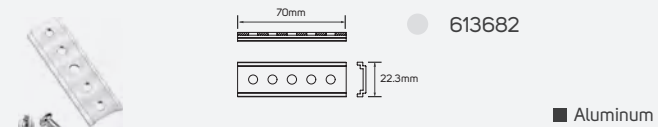



LED Magnetic Track Spot Light (White Version)

PRODUCT INFORMATION

- Modern looking, neat luminaire offering comfortable, good quality lighting and can also work as a design element.
- Ideal lighting in the non-working areas of professional spaces such as offices, educational institutes, and also the welcoming areas and entrances of retail spaces.
- ILLUS LED MAGNETIC TRACK SPOT Light gives the customer the flexibility to choose between 12 models based on their specific need with lumen package from 370 lm to 1050 lm.

BENEFITS

- Clean and uniform light.
- Multiple application use.
- Easy to install and maintain.

FEATURES

- High CRI>90.
- Efficacy up to 106 lm/w.
- Long life span 30,000 hrs.
- Operating voltage DC48 V.
- Non – dimmable.

LED Magnetic Track Spot Light (White Version)

Glorya

Technical Operating & Electrical Data

Input Voltage & Frequency	DC48V, 50/60Hz
IP Ratings	IP20
Body Material	Aluminum+Industrial Plastic
CRI	90
Body Color	Sandy White
Beam Angle	24°
Mounting Type	Track Mounted
Life Span	30000h

Areas of Application

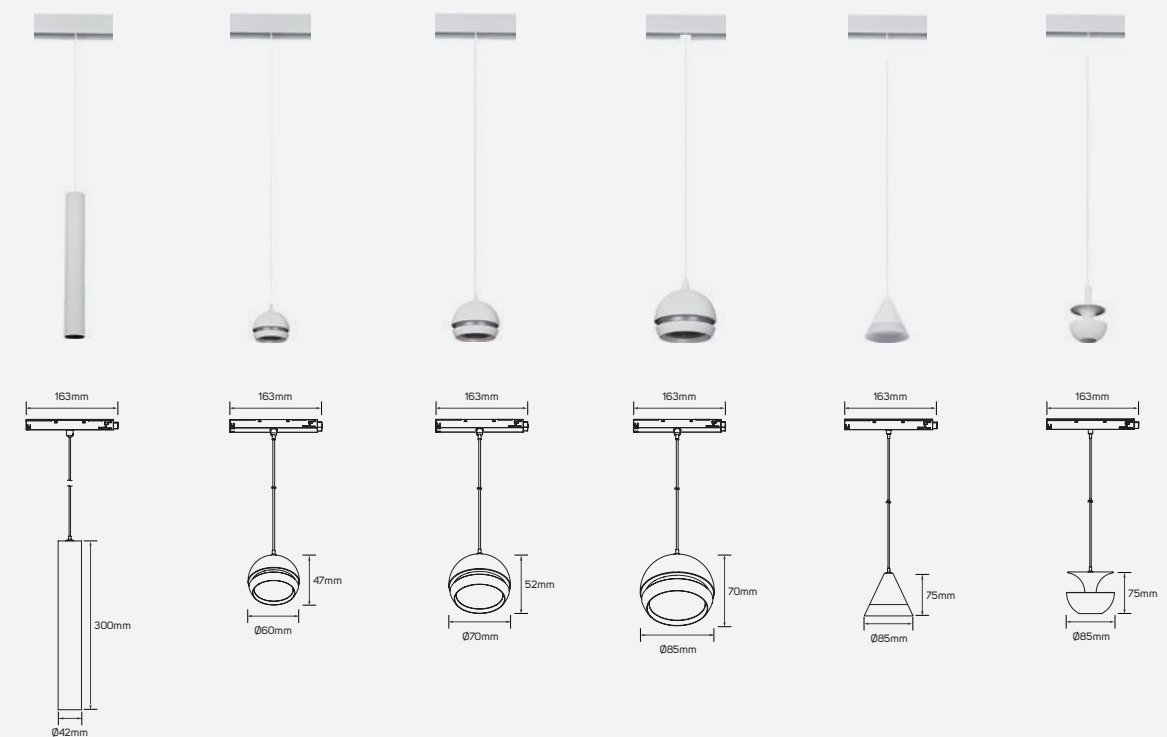

614552 - 614553

614554 - 614555

614556 - 614557

614558 - 614559

614560 - 614561

614562 - 614563

Family Product List

Code No.	Model No.	Power	Lumen	Efficacy	CCT
614552	ILS8.5W24DMTPL930WWW01	8.5W	850lm	100lm/W	3000K
614553	ILS8.5W24DMTPL940NWW01	8.5W	900lm	105.88lm/W	4000K
614554	ILS5W24DMTPL930WWW01	5W	450lm	90lm/W	3000K
614555	ILS5W24DMTPL940NWW01	5W	480lm	96lm/W	4000K
614556	ILS7W24DMTPL930WWW01	7W	650lm	92.86lm/W	3000K
614557	ILS7W24DMTPL940NWW01	7W	700lm	100lm/W	4000K
614558	ILS12W24DMTPL930WWW01	12W	950lm	79.17lm/W	3000K
614559	ILS12W24DMTPL940NWW01	12W	1050lm	87.50lm/W	4000K
614560	ILS4.5W24DMTPL930WWW01	4.5W	370lm	82.22lm/W	3000K
614561	ILS4.5W24DMTPL940NWW01	4.5W	450lm	100lm/W	4000K
614562	ILS4.5W24DMTPL930WWW02	4.5W	380lm	84.44lm/W	3000K
614563	ILS4.5W24DMTPL940NWW02	4.5W	400lm	88.89lm/W	4000K

Recessed Magnetic Track Rail

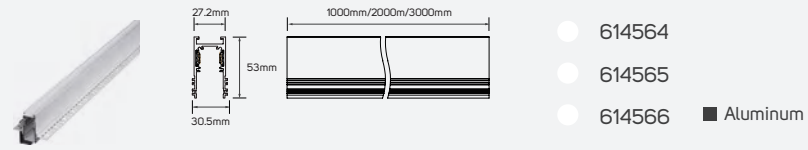

Pendant Magnetic Track Rail

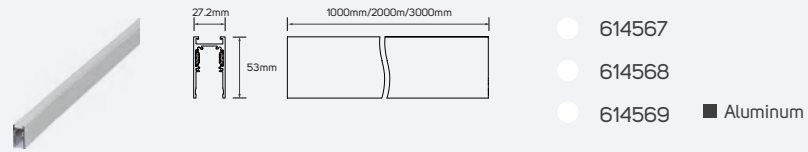

48V Magnetic Driver

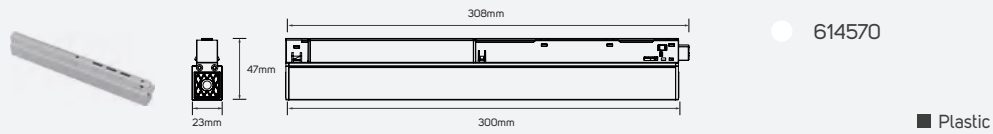

Recessed Horizontal Corner

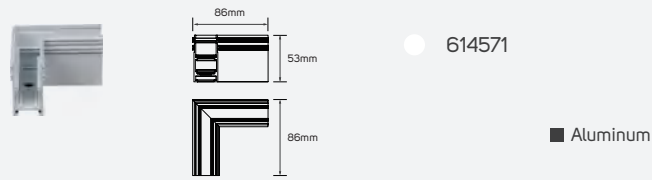

Recessed Inside Corner

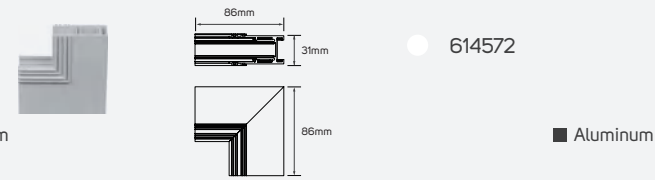

Surface Mounted Horizontal Corner

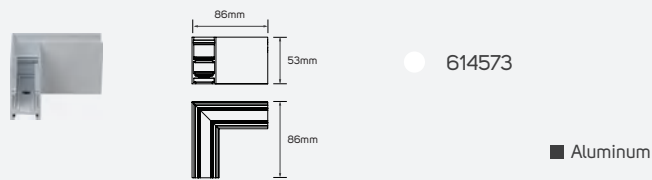

Surface Mounted Inside Corner

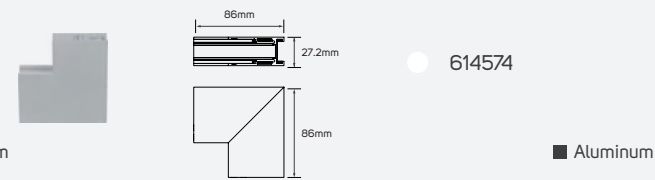

Flexible Corner Conductive Module

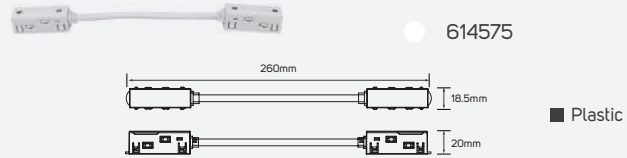

Direct Corner Conductive Module

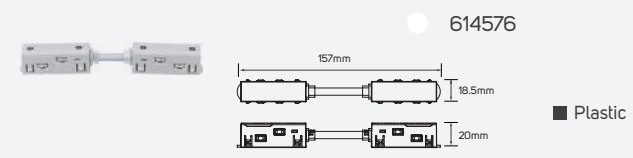

Cable Wire

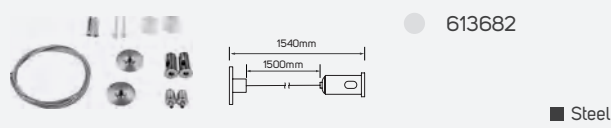

Cable Wire

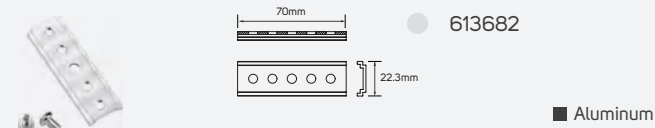





LED Magnetic Lights

Roman Romance

Technical Operating & Electrical Data

Input Voltage & Frequency	DC48V, 50/60Hz
IP Ratings	IP20
Body Material	Aluminum
CRI	90
Body Color	Sandy Black
Beam Angle	30°
Mounting Type	Surface Mounted
Life Span	30000h

Areas of Application

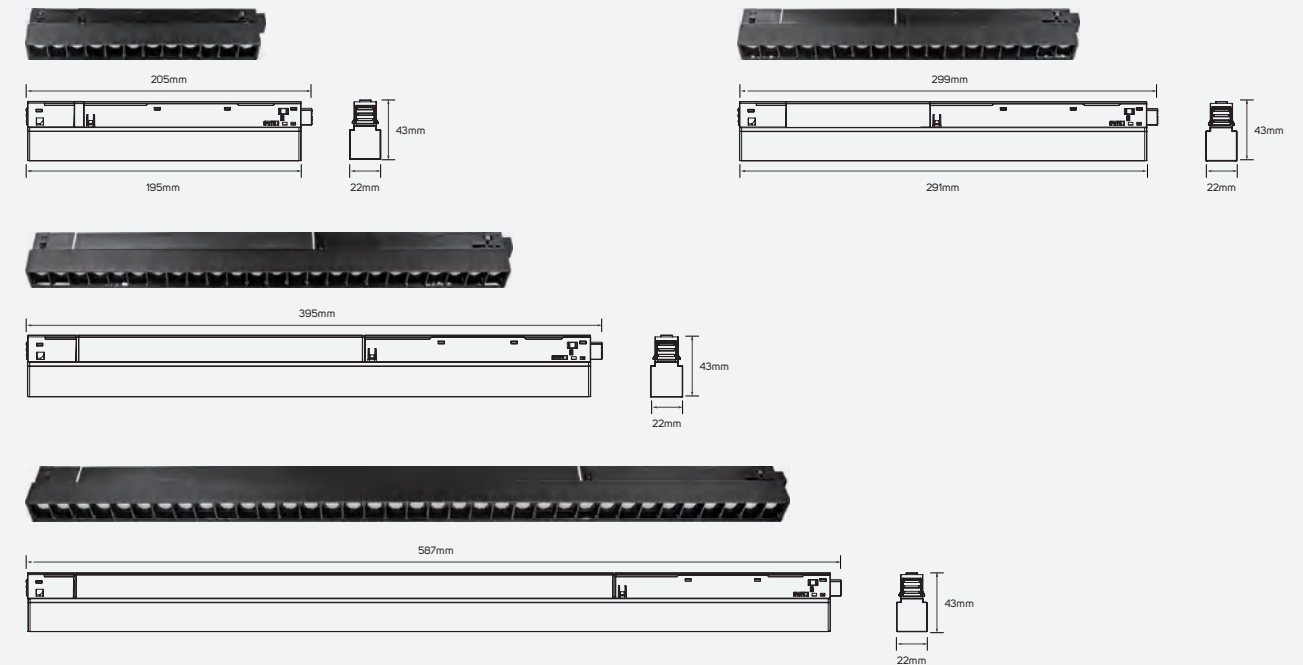
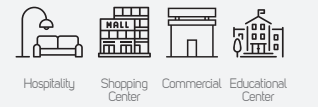

LED Magnetic Lights

PRODUCT INFORMATION

- Modern looking, neat luminaire offering comfortable, good quality lighting and can also work as a design element.
- Ideal lighting in the non-working areas of professional spaces such as offices, educational institutes, and also the welcoming areas and entrances of retail spaces.
- ILLUS LED MAGNETIC TRACK LINEAR Light gives the customer the flexibility to choose between 8 models based on their specific need with lumen package from 750 lm to 2250 lm.

BENEFITS

- Clean and uniform light.
- Multiple application use.
- Easy to install and maintain.

FEATURES

- High CRI>90.
- Efficacy up to 98 lm/w.
- Long life span 30,000 hrs.
- Operating voltage DC48 V.
- Non – dimmable.

Family Product List

Code No.	Model No.	Power	Lumen	Efficacy	CCT
● 613629	ILS9W36DMTL930WW01	8.5W	750lm	88.24lm/W	3000K
● 613630	ILS9W36DMTL940NW01	8.5W	800lm	94.12lm/W	4000K
● 613631	ILS15W36DMTL930WW01	14.5W	1300lm	89.66lm/W	3000K
● 613632	ILS15W36DMTL940NW01	14.5W	1370lm	94.48lm/W	4000K
● 613633	ILS20W36DMTL930WW01	20W	1650lm	82.50lm/W	3000K
● 613634	ILS20W36DMTL940NW01	20W	1750lm	87.50lm/W	4000K
● 613635	ILS24W110DMTL930WW01	23W	2050lm	89.13lm/W	3000K
● 613636	ILS24W110DMTL940NW01	23W	2250lm	97.83lm/W	4000K

Recessed Magnetic Track Rail

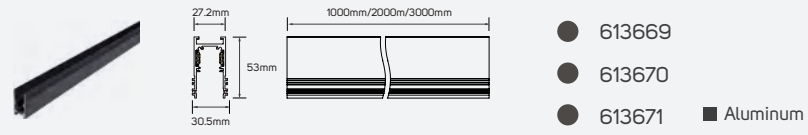

Pendant Magnetic Track Rail

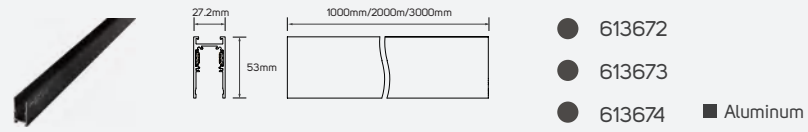

48V Magnetic Driver

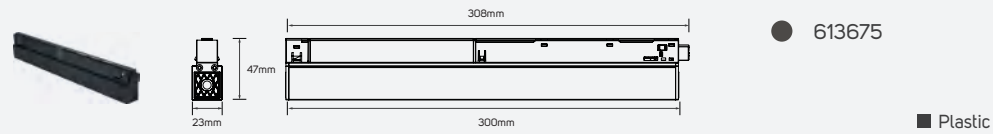

Recessed Horizontal Corner

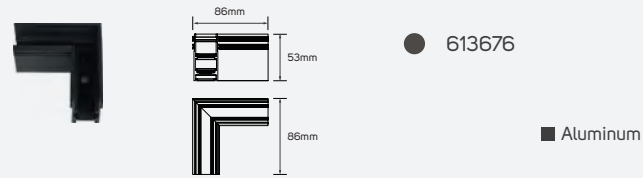

Recessed Inside Corner

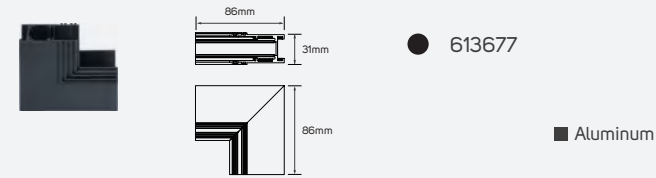

Surface Mounted Horizontal Corner

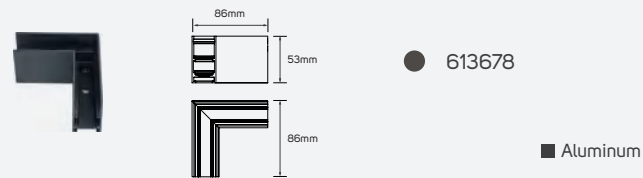

Surface Mounted Inside Corner

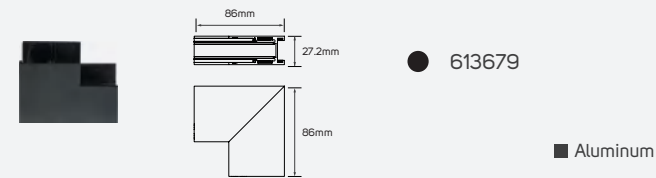

Flexible Corner Conductive Module

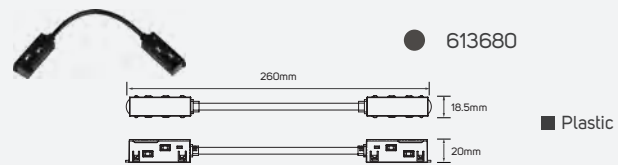

Direct Corner Conductive Module

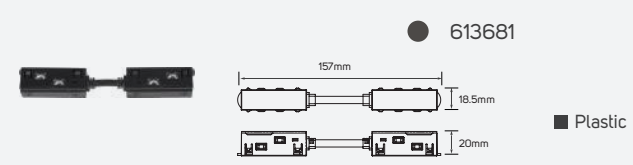

Cable Wire

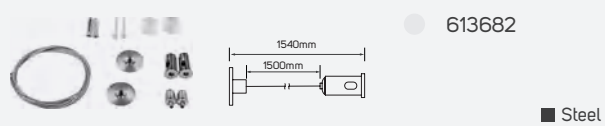

Cable Wire

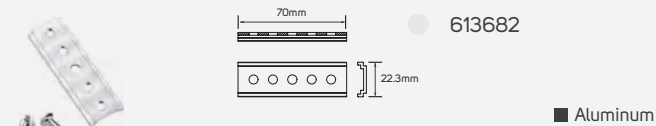

LED Magnetic Lights

Roman Romance

Technical Operating & Electrical Data

Input Voltage & Frequency	DC48V, 50/60Hz
IP Ratings	IP20
Body Material	Aluminum
CRI	90
Body Color	Sandy White
Beam Angle	30°
Mounting Type	Surface Mounted
Life Span	30000h

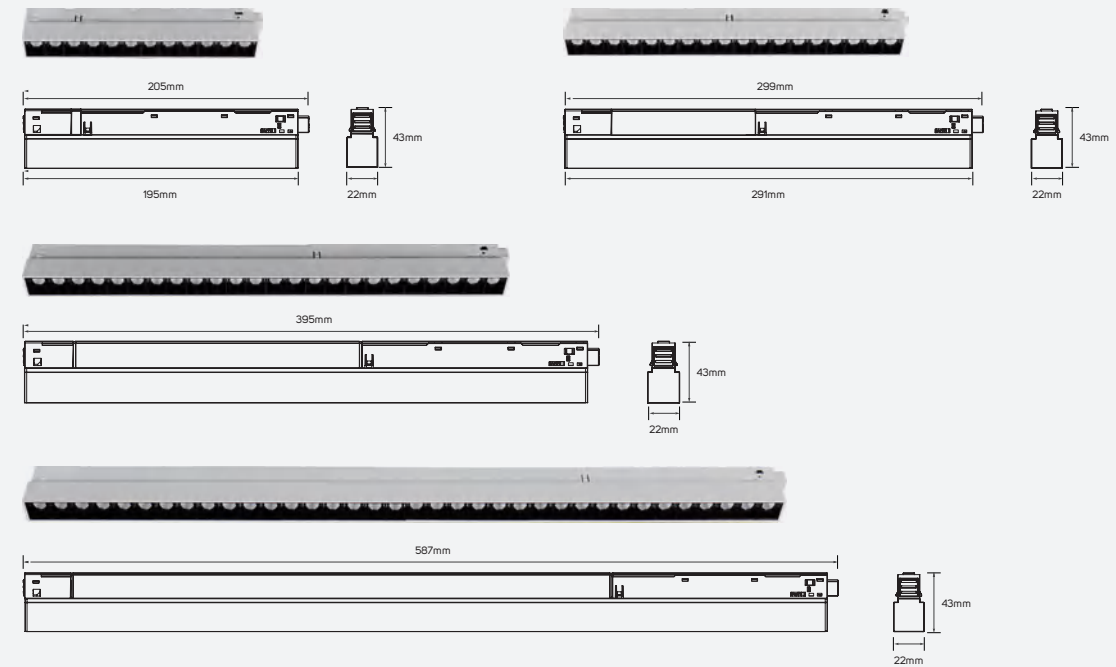

Areas of Application

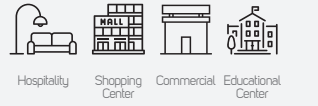

Family Product List

Code No.	Model No.	Power	Lumen	Efficacy	CCT
614524	ILS8.5W30DMTL930WWW01	8.5W	750lm	88.24lm/W	3000K
614525	ILS8.5W30DMTL940NWW01	8.5W	800lm	94.12lm/W	4000K
614526	ILS14.5W30DMTL930WWW01	14.5W	1300lm	89.66lm/W	3000K
614527	ILS14.5W30DMTL940NWW01	14.5W	1370lm	94.48lm/W	4000K
614528	ILS20W30DMTL930WWW01	20W	1650lm	82.50lm/W	3000K
614529	ILS20W30DMTL940NWW01	20W	1750lm	87.50lm/W	4000K
614530	ILS23W30DMTL930WWW01	23W	2050lm	89.13lm/W	3000K
614531	ILS23W30DMTL940NWW01	23W	2250lm	97.83lm/W	4000K

Recessed Magnetic Track Rail

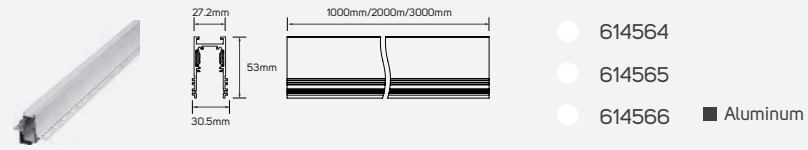

Pendant Magnetic Track Rail

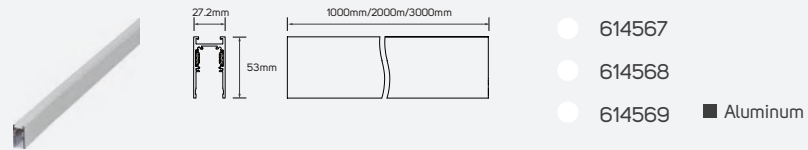

48V Magnetic Driver

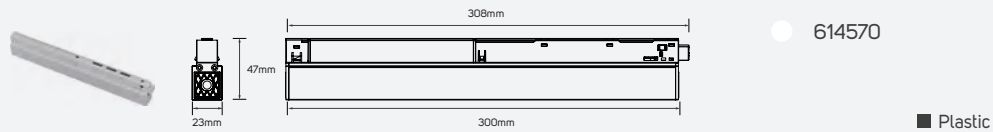

Recessed Horizontal Corner

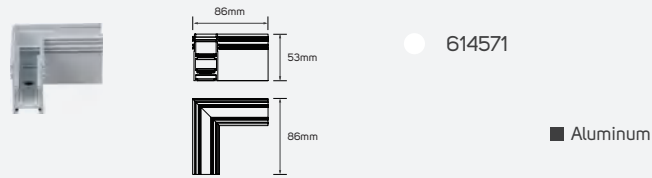

Recessed Inside Corner

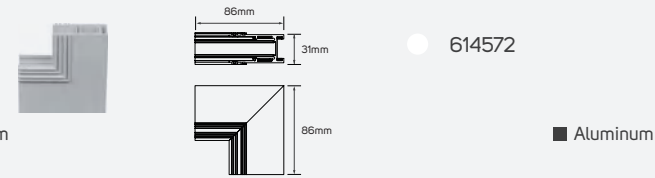

Surface Mounted Horizontal Corner

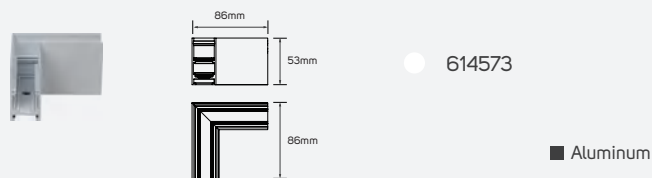

Surface Mounted Inside Corner

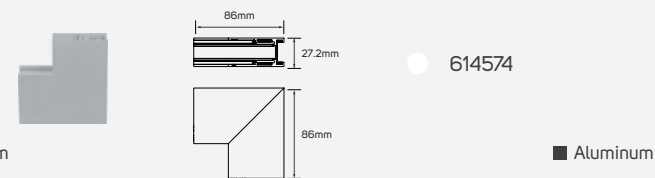

Flexible Corner Conductive Module

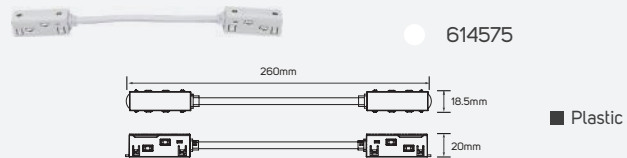

Direct Corner Conductive Module

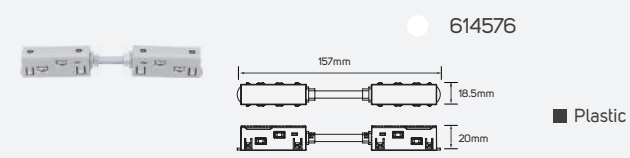

Cable Wire

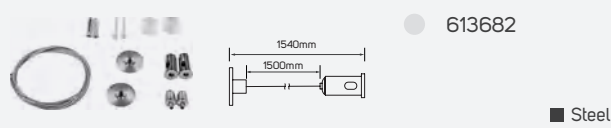

Cable Wire

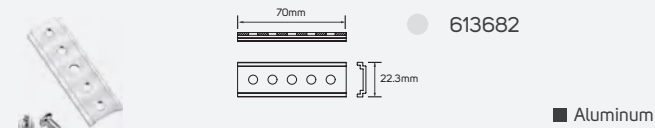

LED Magnetic Lights

Roman Romance

Technical Operating & Electrical Data

Input Voltage & Frequency	DC48V, 50/60Hz
IP Ratings	IP20
Body Material	Aluminum
CRI	90
Body Color	Sandy Black
Beam Angle	30°
Mounting Type	Surface Mounted
Life Span	30000h

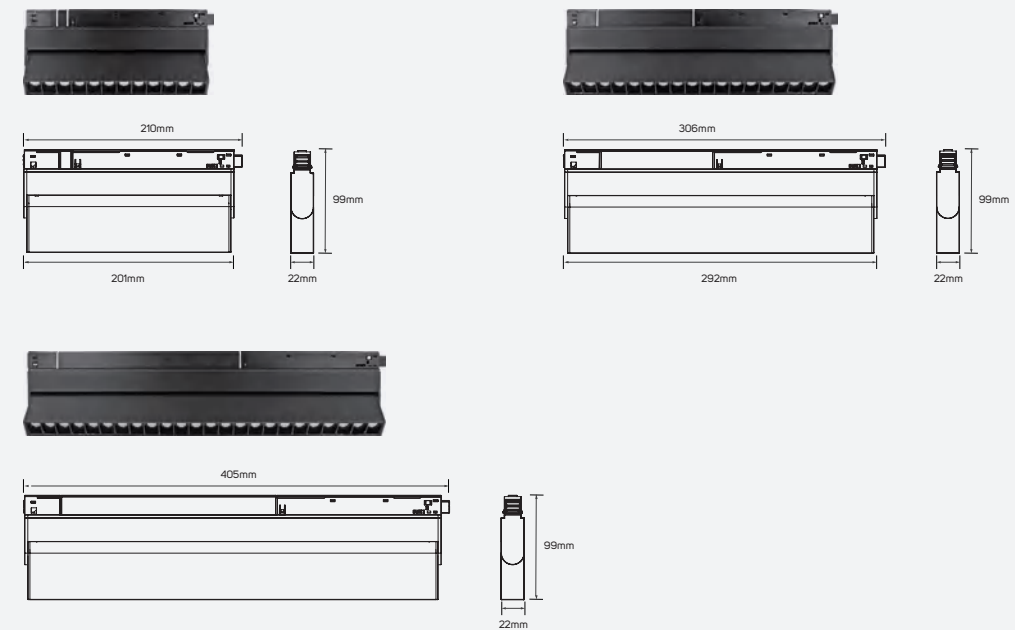

Family Product List

Code No.	Model No.	Power	Lumen	Efficacy	CCT
● 613637	ILS9W36DRTL930WW02	8.5W	750lm	88.24lm/W	3000K
● 613638	ILS9W36DRTL940NW02	8.5W	800lm	94.12lm/W	4000K
● 613639	ILS15W36DRTL930WW02	15W	1300lm	86.67lm/W	3000K
● 613640	ILS15W36DRTL940NW02	15W	1370lm	91.33lm/W	4000K
● 613641	ILS20W36DRTL930WW02	20W	1750lm	87.50lm/W	3000K
● 613642	ILS20W36DRTL940NW02	20W	1850lm	92.50lm/W	4000K

Areas of Application



Recessed Magnetic Track Rail

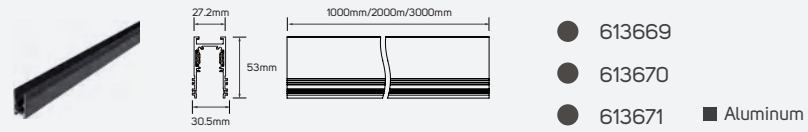

Pendant Magnetic Track Rail

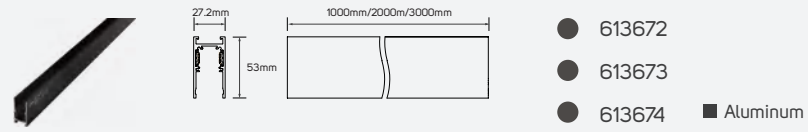

48V Magnetic Driver

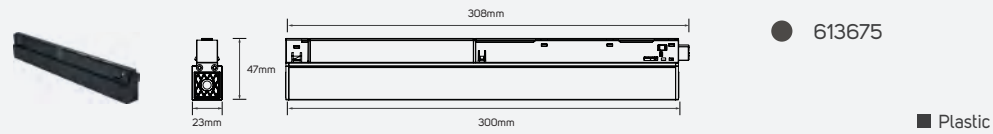

Recessed Horizontal Corner

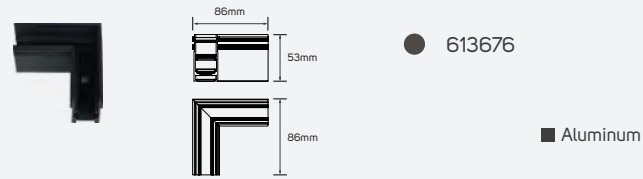

Recessed Inside Corner

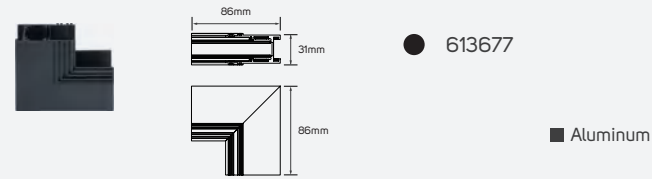

Surface Mounted Horizontal Corner

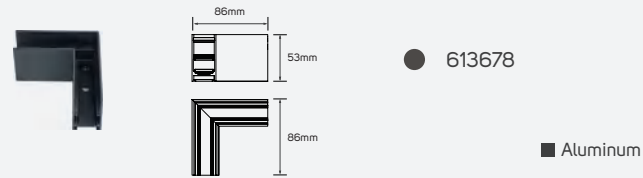

Surface Mounted Inside Corner

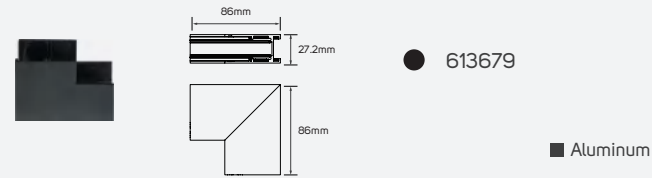

Flexible Corner Conductive Module

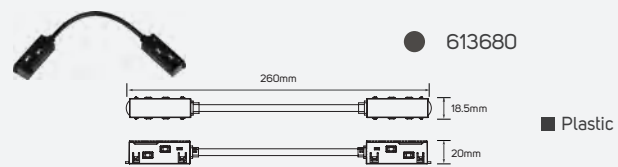

Direct Corner Conductive Module

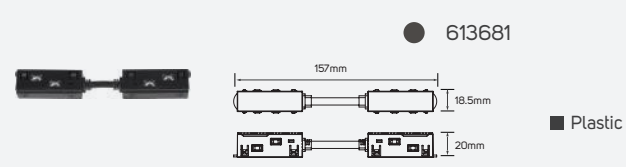

Cable Wire

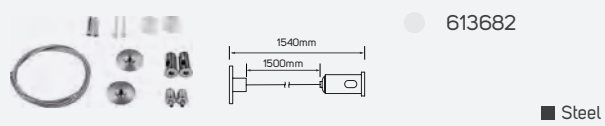

Cable Wire

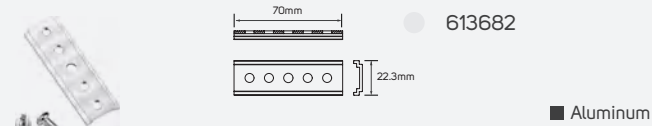

LED Magnetic Lights

Roman Romance

Technical Operating & Electrical Data

Input Voltage & Frequency	DC48V, 50/60Hz
IP Ratings	IP20
Body Material	Aluminum
CRI	90
Body Color	Sandy White
Beam Angle	30°
Mounting Type	Surface Mounted
Life Span	30000h

614532	8.5W	3000K	750lm	614536	20W	3000K	1750lm
614533	8.5W	4000K	800lm	614537	20W	4000K	1850lm
614534	15W	3000K	1300lm				
614535	15W	4000K	1370lm				

Areas of Application

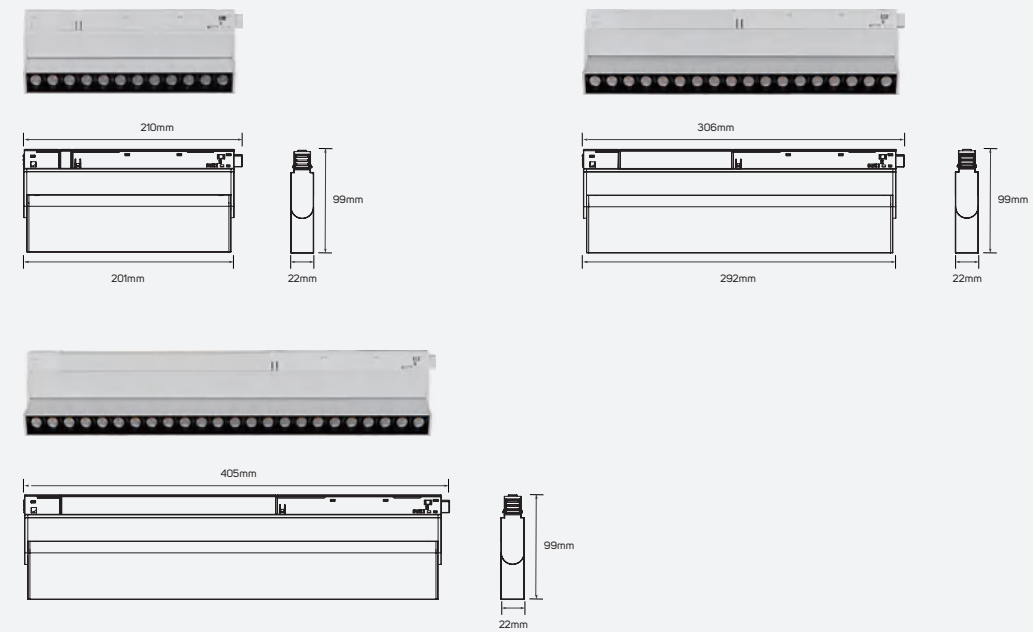
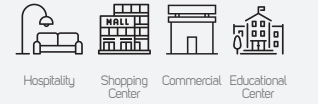

Family Product List

Code No.	Model No.	Power	Lumen	Efficacy	CCT
614532	ILS8.5W30DMTL930WWW02	8.5W	750lm	88.24lm/W	3000K
614533	ILS8.5W30DMTL940NWW02	8.5W	800lm	94.12lm/W	4000K
614534	ILS15W30DMTL930WWW02	15W	1300lm	86.67lm/W	3000K
614535	ILS15W30DMTL940NWW02	15W	1370lm	91.33lm/W	4000K
614536	ILS20W30DMTL930WWW02	20W	1750lm	87.50lm/W	3000K
614537	ILS20W30DMTL940NWW02	20W	1850lm	92.50lm/W	4000K

Recessed Magnetic Track Rail

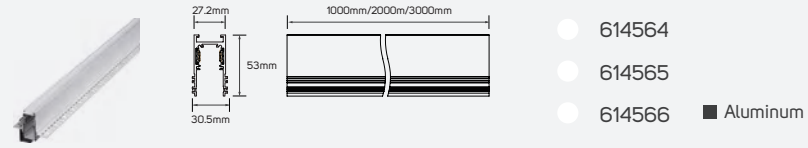

Pendant Magnetic Track Rail

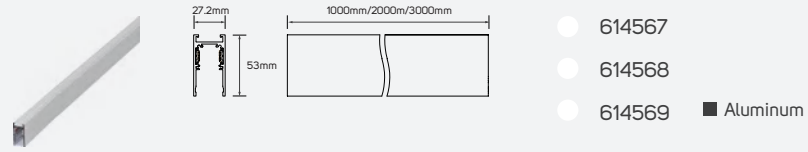

48V Magnetic Driver

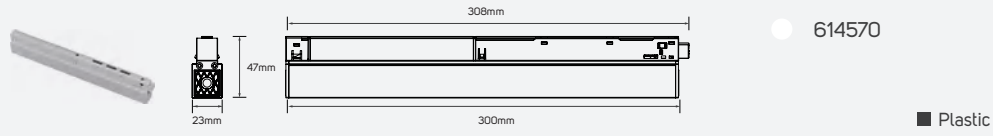

Recessed Horizontal Corner

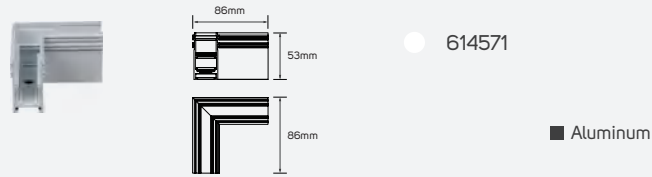

Recessed Inside Corner

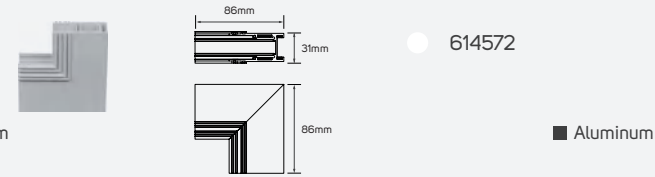

Surface Mounted Horizontal Corner

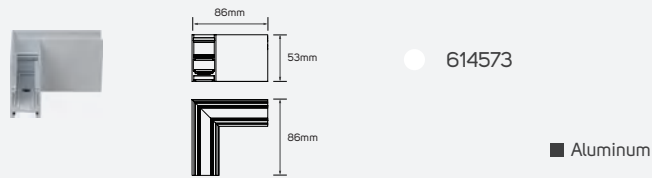

Surface Mounted Inside Corner

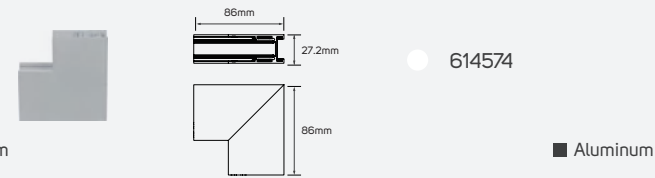

Flexible Corner Conductive Module

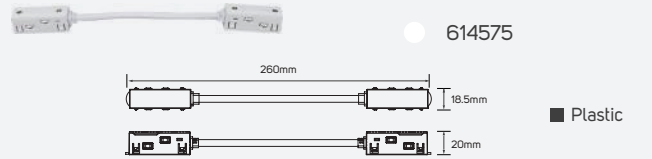

Direct Corner Conductive Module

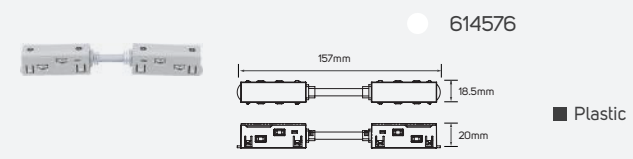

Cable Wire

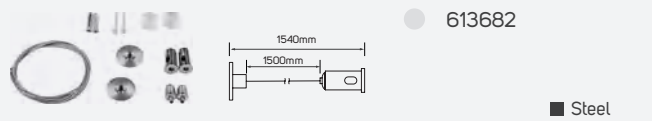

Cable Wire

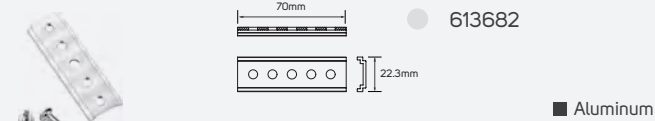



LED Magnetic Lights

Shimmering Moments

Technical Operating & Electrical Data

Input Voltage & Frequency	DC48V, 50/60Hz
IP Ratings	IP20
Body Material	Aluminum
CRI	90
Body Color	Sandy Black
Beam Angle	90°
Mounting Type	Surface Mounted
Life Span	30000h

Areas of Application

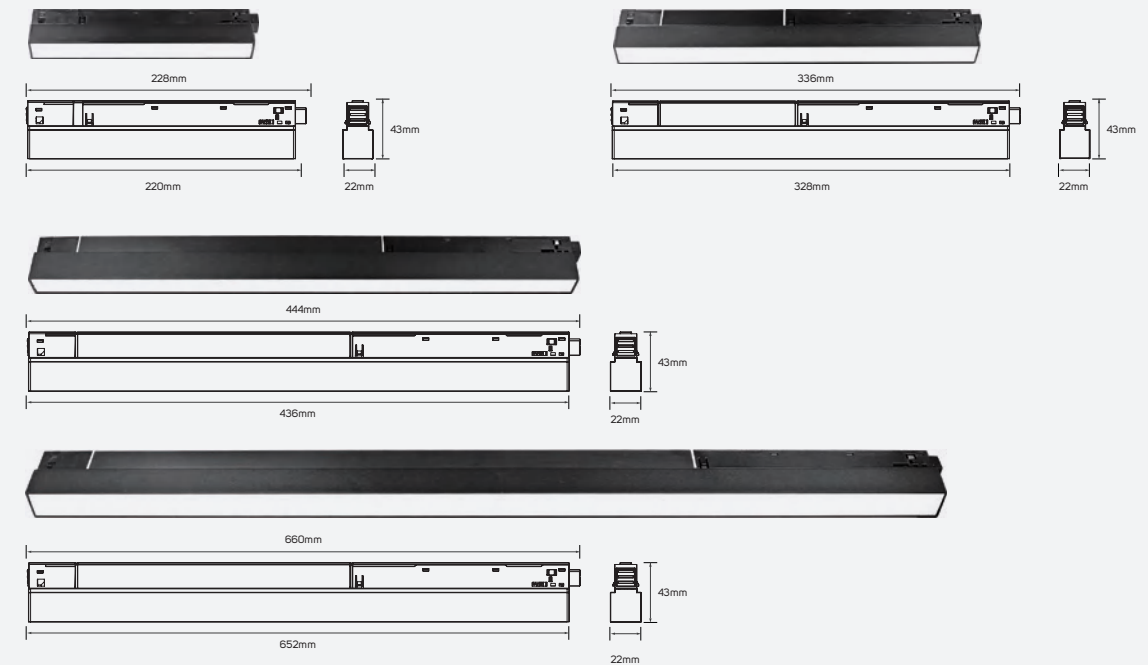
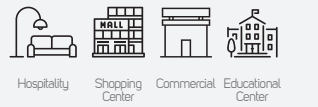

LED Magnetic Lights

PRODUCT INFORMATION

- Modern looking, neat luminaire offering comfortable, good quality lighting and can also work as a design element.
- Ideal lighting in the non-working areas of professional spaces such as offices, educational institutes, and also the welcoming areas and entrances of retail spaces.
- ILLUS LED MAGNETIC TRACK Light gives the customer the flexibility to choose between 8 models based on their specific need with lumen package from 570 lm to 1900 lm.

BENEFITS

- Clean and uniform light.
- Multiple application use.
- Easy to install and maintain.

FEATURES

- High CRI>90.
- Efficacy up to 81 lm/w.
- Long life span 30,000 hrs.
- Operating voltage DC48 V.
- Non – dimmable.

Family Product List

Code No.	Model No.	Power	Lumen	Efficacy	CCT
● 613643	ILS9W110DML930WW03	8W	570lm	71.25lm/W	3000K
● 613644	ILS9W110DML940NW03	8W	600lm	75lm/W	4000K
● 613645	ILS15W110DML930WW03	15W	1110lm	74lm/W	3000K
● 613646	ILS15W110DML940NW03	15W	1170lm	78lm/W	4000K
● 613647	ILS20W110DML930WW03	21W	1600lm	76.19lm/W	3000K
● 613648	ILS20W110DML940NW03	21W	1700lm	80.95lm/W	4000K
● 613649	ILS24W110DML930WW03	24W	1750lm	72.92lm/W	3000K
● 613650	ILS24W110DML940NW03	24W	1900lm	79.17lm/W	4000K

Recessed Magnetic Track Rail

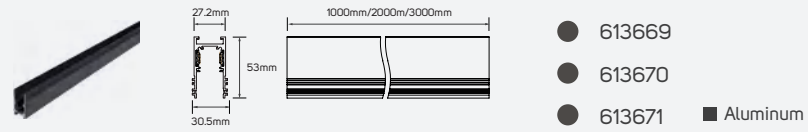

Pendant Magnetic Track Rail

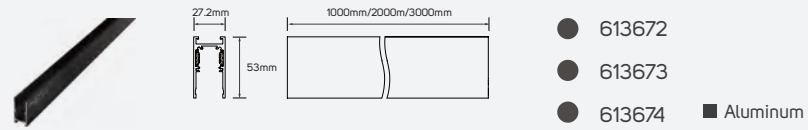

48V Magnetic Driver

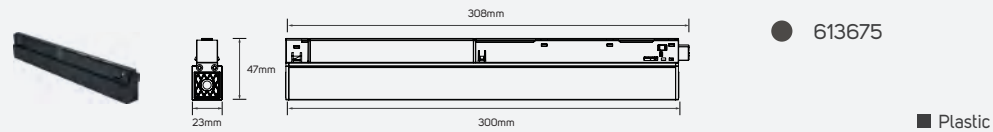

Recessed Horizontal Corner

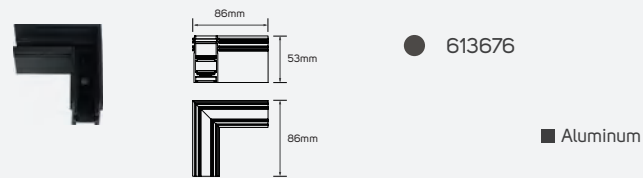

Recessed Inside Corner

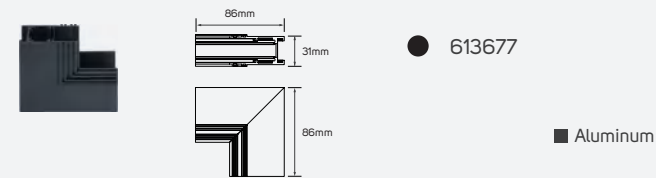

Surface Mounted Horizontal Corner

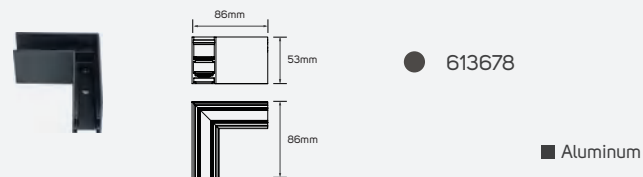

Surface Mounted Inside Corner

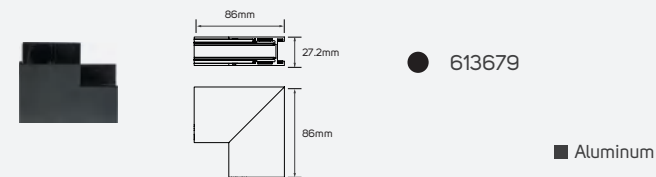

Flexible Corner Conductive Module

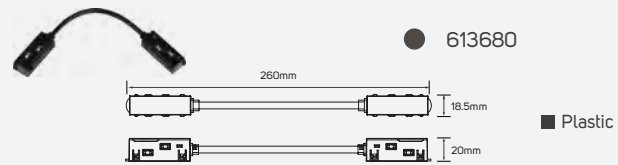

Direct Corner Conductive Module

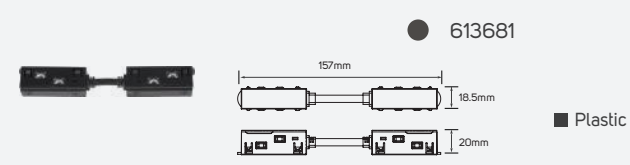

Cable Wire

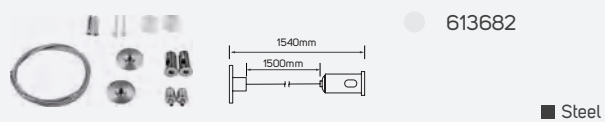

Cable Wire

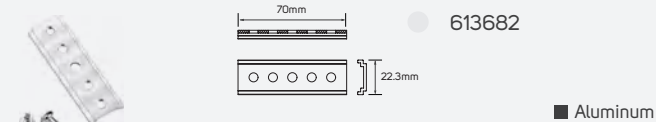

LED Magnetic Lights

Shimmering Moments

Technical Operating & Electrical Data

Input Voltage & Frequency	DC48V, 50/60Hz
IP Ratings	IP20
Body Material	Aluminum
CRI	90
Body Color	Sandy White
Beam Angle	90°
Mounting Type	Surface Mounted
Life Span	30000h

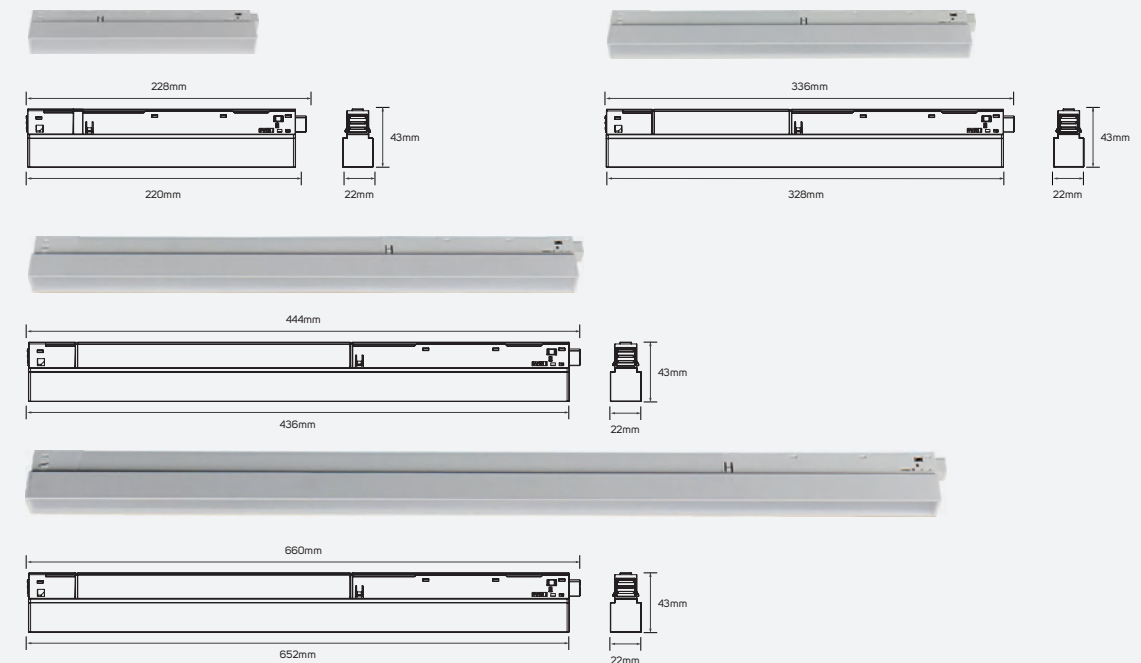

Family Product List

Code No.	Model No.	Power	Lumen	Efficacy	CCT
614538	ILS9W110DMTL930WW03	8W	570lm	71.25lm/W	3000K
614539	ILS9W110DMTL940NW03	8W	600lm	75lm/W	4000K
614540	ILS15W110DMTL930WW03	15W	1110lm	74lm/W	3000K
614541	ILS15W110DMTL940NW03	15W	1170lm	78lm/W	4000K
614542	ILS20W110DMTL930WW03	21W	1600lm	76.19lm/W	3000K
614543	ILS20W110DMTL940NW03	21W	1700lm	80.95lm/W	4000K
614544	ILS24W110DMTL930WW03	24W	1750lm	72.92lm/W	3000K
614545	ILS24W110DMTL940NW03	24W	1900lm	79.17lm/W	4000K

Areas of Application



Recessed Magnetic Track Rail

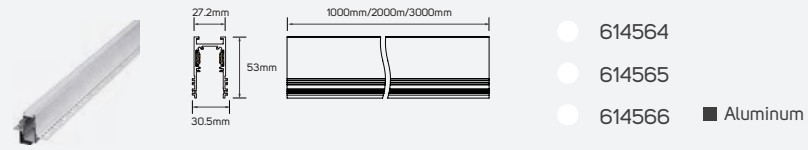

Pendant Magnetic Track Rail

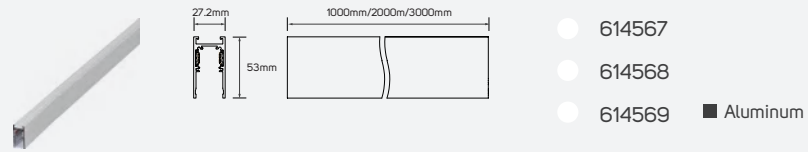

48V Magnetic Driver

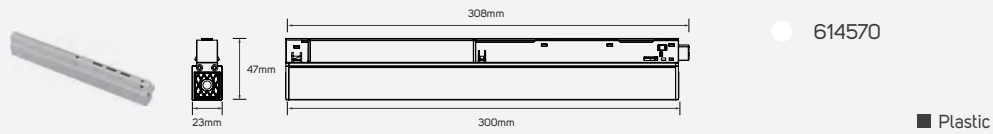

Recessed Horizontal Corner

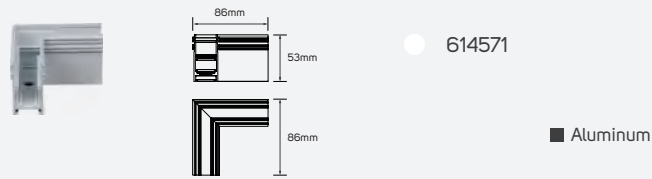

Recessed Inside Corner

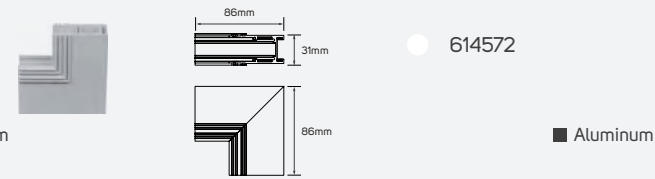

Surface Mounted Horizontal Corner

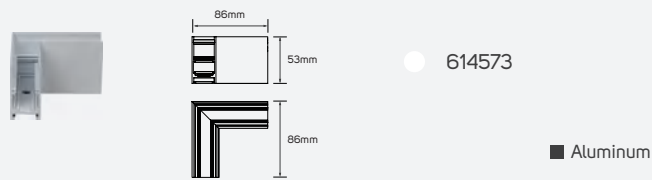

Surface Mounted Inside Corner

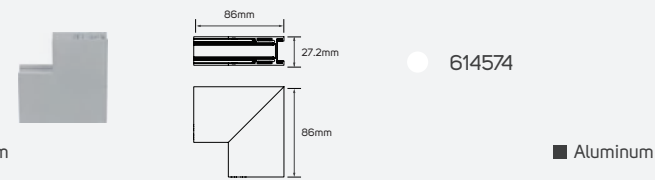

Flexible Corner Conductive Module

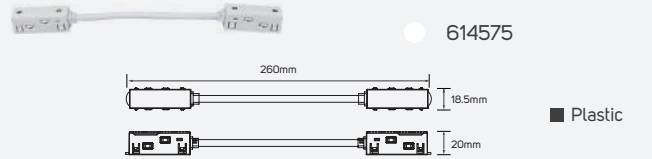

Direct Corner Conductive Module

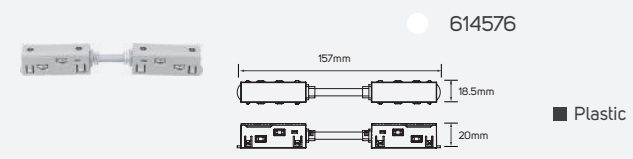

Cable Wire

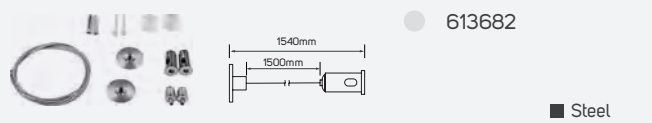

Cable Wire

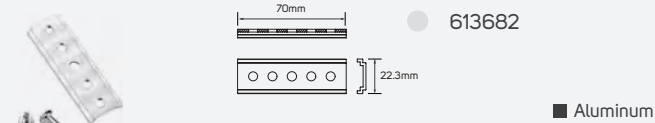



LED Magnetic Lights

Rhythmic Joy

Technical Operating & Electrical Data

Input Voltage & Frequency	DC48V, 50/60Hz
IP Ratings	IP20
Body Material	Aluminum
CRI	90
Body Color	Sandy Black
Beam Angle	24°
Mounting Type	Track Mounted
Life Span	30000h

Areas of Application

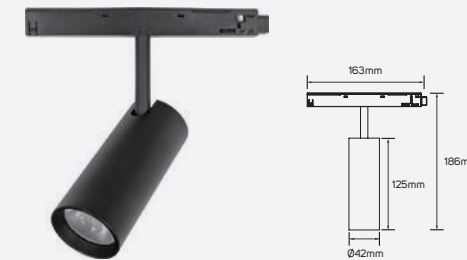
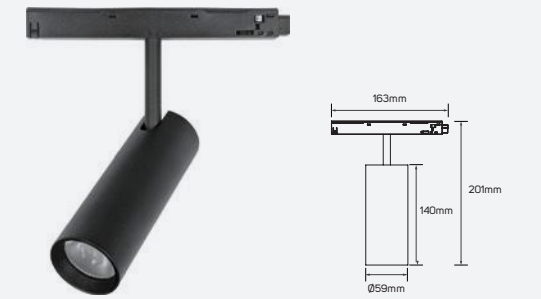
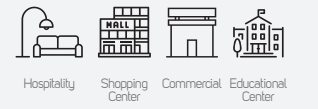

Family Product List

Code No.	Model No.	Power	Lumen	Efficacy	CCT
● 613651	ILS9W24DMTSL930WW01	8W	800lm	100lm/W	3000K
● 613652	ILS9W24DMTSL940NW01	8W	850lm	106.25lm/W	4000K
● 613653	ILS12W24DMTSL930WW01	12.5W	1150lm	92lm/W	3000K
● 613654	ILS12W24DMTSL940NW01	12.5W	1220lm	97.60lm/W	4000K
● 613655	ILS18W24DMTSL930WW01	16W	1350lm	84.38lm/W	3000K
● 613656	ILS18W24DMTSL940NW01	16W	1450lm	90.63lm/W	4000K

Recessed Magnetic Track Rail

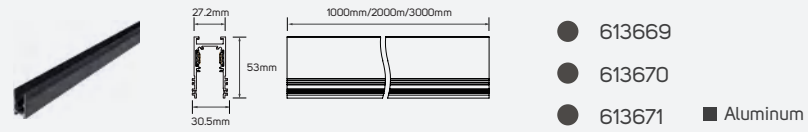

Pendant Magnetic Track Rail

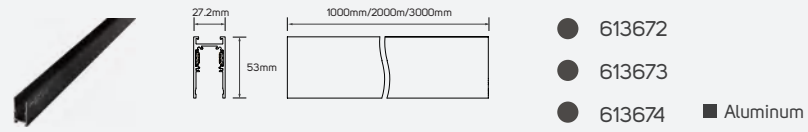

48V Magnetic Driver

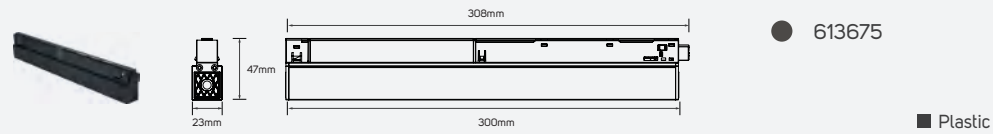

Recessed Horizontal Corner

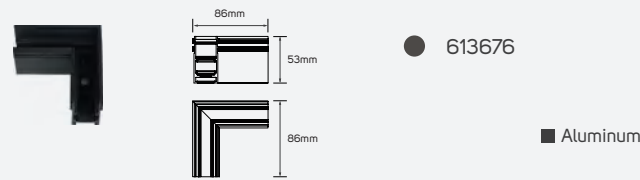

Recessed Inside Corner

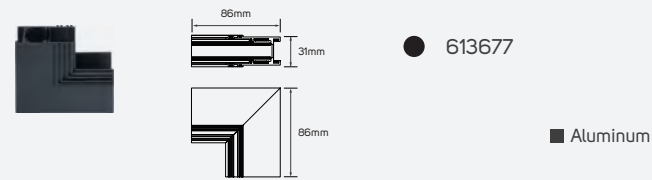

Surface Mounted Horizontal Corner

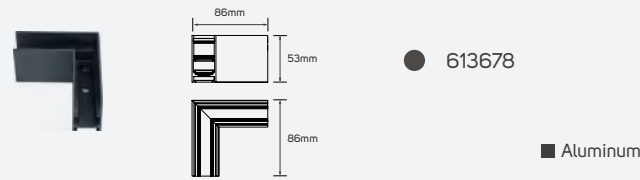

Surface Mounted Inside Corner

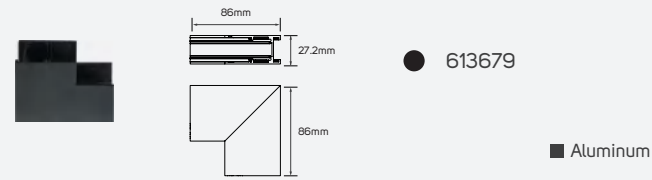

Flexible Corner Conductive Module

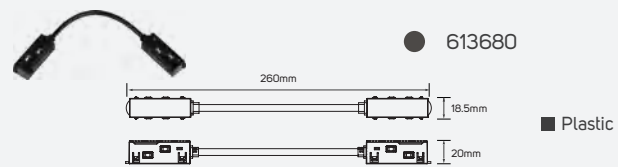

Direct Corner Conductive Module

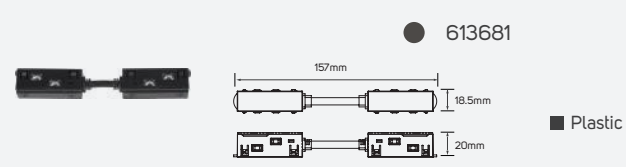

Cable Wire

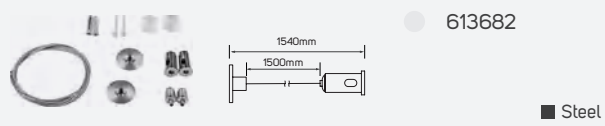

Cable Wire

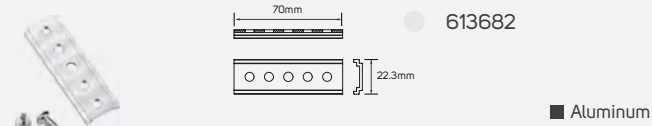

LED Magnetic Lights

Rhythmic Joy

Technical Operating & Electrical Data

Input Voltage & Frequency	DC48V, 50/60Hz
IP Ratings	IP20
Body Material	Aluminum
CRI	90
Body Color	Sandy White
Beam Angle	24°
Mounting Type	Track Mounted
Life Span	30000h

Areas of Application

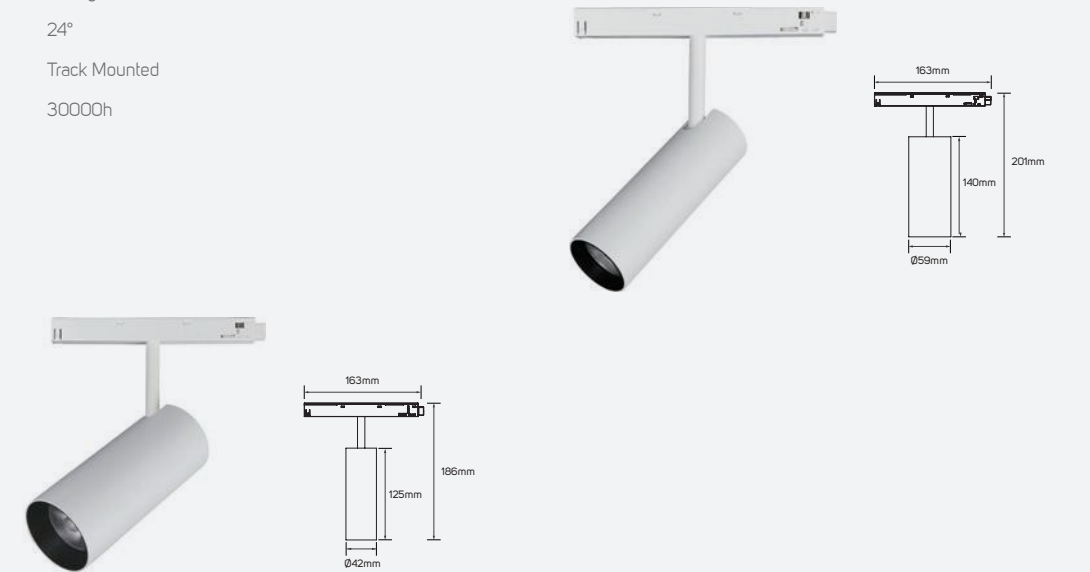
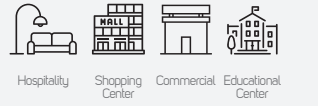

Family Product List

Code No.	Model No.	Power	Lumen	Efficacy	CCT
614546	ILS8W24DMTSL930WWW01	8W	800lm	100lm/W	3000K
614547	ILS8W24DMTSL940NWW01	8W	850lm	106.25lm/W	4000K
614548	ILS12.5W24DMTSL930WWW01	12.5W	1150lm	92lm/W	3000K
614549	ILS12.5W24DMTSL940NWW01	12.5W	1220lm	97.60lm/W	4000K
614550	ILS16W24DMTSL930WWW01	16W	1350lm	84.38lm/W	3000K
614551	ILS16W24DMTSL940NWW01	16W	1450lm	90.63lm/W	4000K

Recessed Magnetic Track Rail

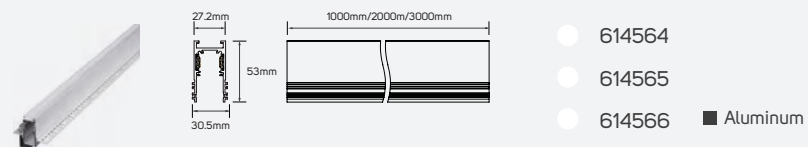

Pendant Magnetic Track Rail

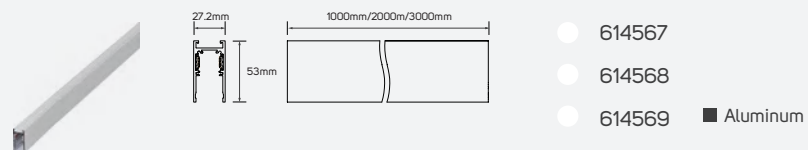

48V Magnetic Driver

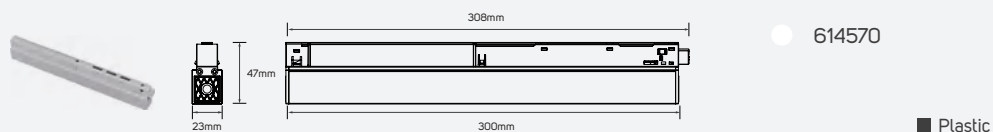

Recessed Horizontal Corner

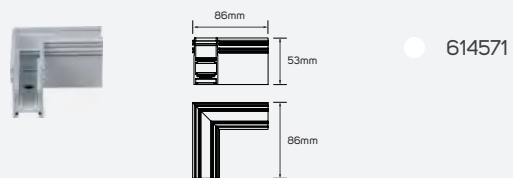

Recessed Inside Corner

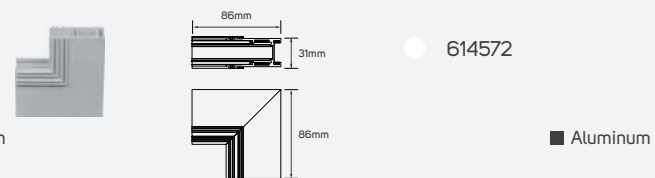

Surface Mounted Horizontal Corner

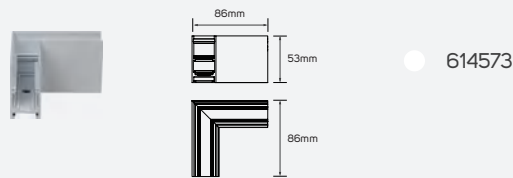

Surface Mounted Inside Corner

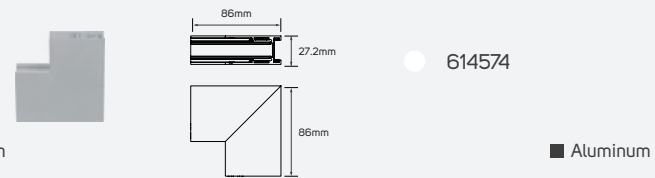

Flexible Corner Conductive Module

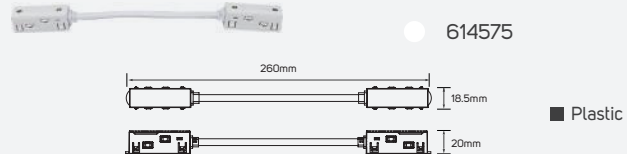

Direct Corner Conductive Module

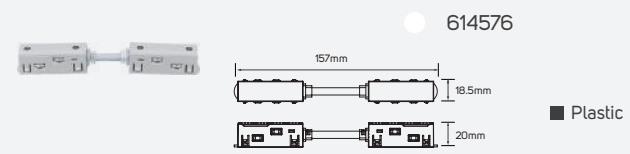

Cable Wire

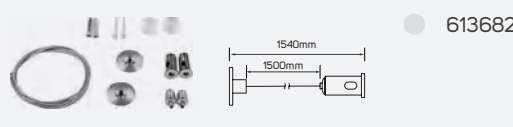

Cable Wire

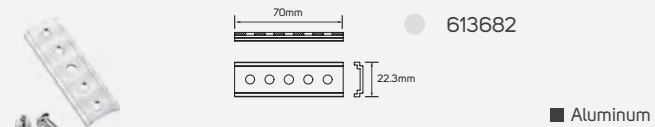



LED Recessed & Surface Mounted Ceiling Luminaire

- IP65 Downlight
- SMD
- SMD CCT
- Economic SMD With PMMA Cover
- SMD+Reflector
- Plastic DOB Downlight
- Mini Downlight



IP65 Downlight

RainShine

Technical Operating & Electrical Data

Input Voltage & Frequency	AC220-240V, 50/60Hz
IP Ratings	IP65
Body Material	Aluminum
Mounting Type	Recessed in Ceiling
Dimming	Non-Dimmable
Life Span	50000h

Areas of Application

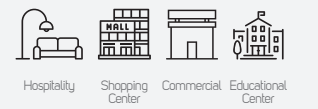

Body Color Options

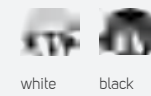

white black

Reflector Color Options

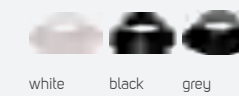

white black grey

Surface mounted kit Color Options

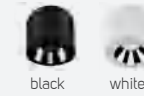

black white

Lens Options

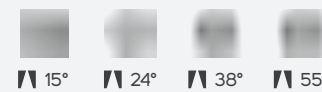

15° 24° 38° 55°

Dimensions Options

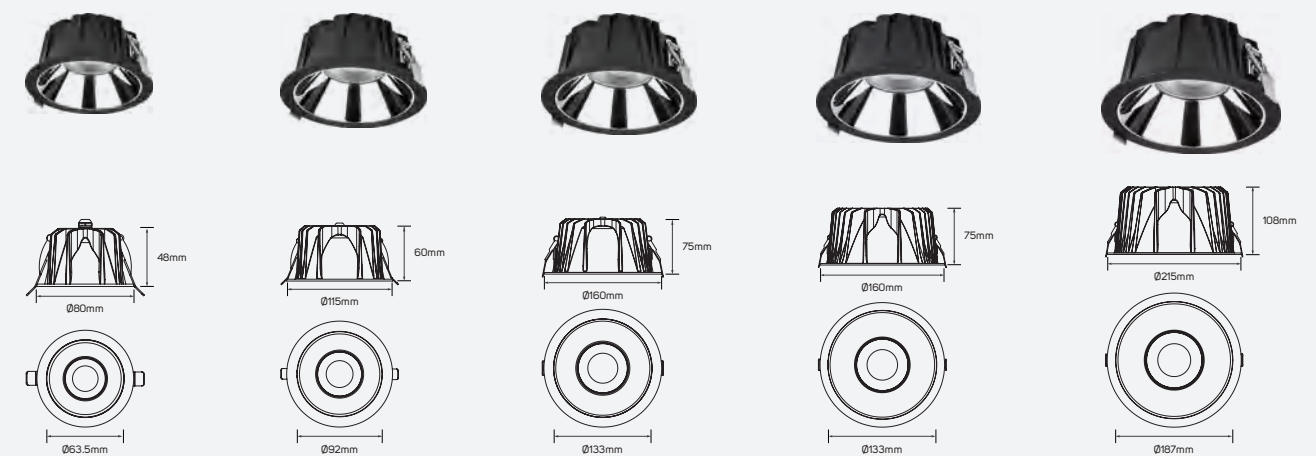

IP65 Downlight

PRODUCT INFORMATION

- Suitable for a series of lighting applications in office, retail and general area lighting.
- Available in a wide variety of lumen packs, cut out size and color temperature.
- ILLUS LED RECESSED CEILING Luminaire gives the customer the flexibility to choose between 30 models based on their specific need with lumen package from 610 lm to 4500 lm.

BENEFITS

- Compact design for better integration with the building.
- Comfortable light with high efficiency.
- Reliable performance for indoor applications.

FEATURES

- High CRI>90.
- Efficacy up to 82lm/w.
- Long life span 50,000 hrs.
- Operating voltage AC220 - 240V.
- Non - dimmable.



Reflector Specifications

■ Plastic

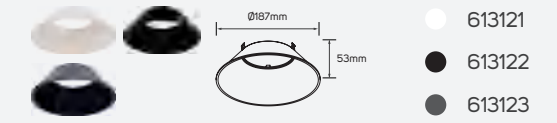
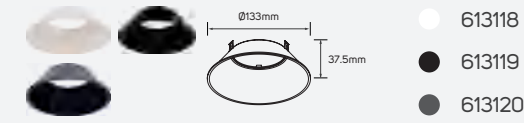
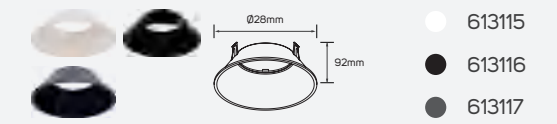
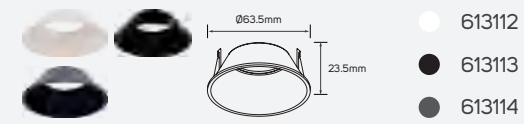

Surface Mounted Kit Specifications

■ Plastic

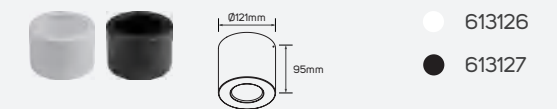
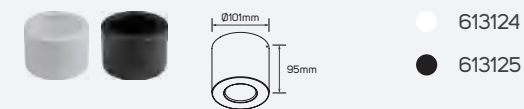

Lens Specifications

■ PC

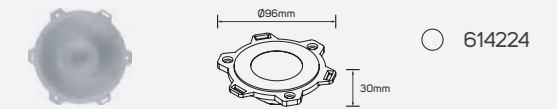
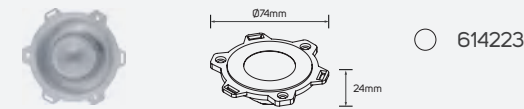
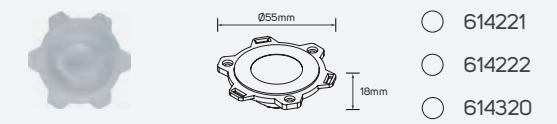
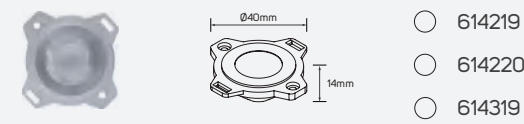

Family Product List

Code No.	Model No.	Body Color	Power	Lumen	Efficacy	CCT	Beam Angle	Cutting Size
● 613077	ILS9DL0930WW01	white	9W	610lm	67.78lm/w	3000K	24°	Ø70mm
● 613078	ILS9DL0940NW01	white	9W	640lm	71.11lm/w	4000K	24°	Ø70mm
● 613079	ILS9DL0950DL01	white	9W	660lm	73.33lm/w	5000K	24°	Ø70mm
● 613080	ILS9DL0930WW02	black	9W	610lm	67.78lm/w	3000K	24°	Ø70mm
● 613081	ILS9DL0940NW02	black	9W	640lm	71.11lm/w	4000K	24°	Ø70mm
● 613082	ILS9DL0950DL02	black	9W	660lm	73.33lm/w	5000K	24°	Ø70mm
● 613083	ILS15DL0930WW01	white	15W	1120lm	74.67lm/w	3000K	24°	Ø100mm
● 613084	ILS15DL0940NW01	white	15W	1130lm	75.33lm/w	4000K	24°	Ø100mm
● 613085	ILS15DL0950DL01	white	15W	1140lm	76lm/w	5000K	24°	Ø100mm
● 613086	ILS15DL0930WW02	black	15W	1120lm	74.67lm/w	3000K	24°	Ø100mm
● 613087	ILS15DL0940NW02	black	15W	1130lm	75.33lm/w	4000K	24°	Ø100mm
● 613088	ILS15DL0950DL02	black	15W	1140lm	76lm/w	5000K	24°	Ø100mm
● 613089	ILS20DL0930WW02	white	20W	1450lm	72.5lm/w	3000K	36°	Ø140mm
● 613090	ILS20DL0940NW02	white	20W	1510lm	75.5lm/w	4000K	36°	Ø140mm
● 613091	ILS20DL0950DL02	white	20W	1550lm	77.5lm/w	5000K	36°	Ø140mm
● 613092	ILS20DL0930WW01	black	20W	1450lm	72.5lm/w	3000K	36°	Ø140mm
● 613093	ILS20DL0940NW01	black	20W	1510lm	75.5lm/w	4000K	36°	Ø140mm
● 613094	ILS20DL0950DL01	black	20W	1550lm	77.5lm/w	5000K	36°	Ø140mm

Family Product List

Code No.	Model No.	Body Color	Power	Lumen	Efficacy	CCT	Beam Angle	Cutting Size
● 613095	ILS37DLO930WW01	white	37W	2700lm	72.98lm/w	3000K	36°	Ø200mm
● 613096	ILS37DLO940NW01	white	37W	2900lm	78.38lm/w	4000K	36°	Ø200mm
● 613097	ILS37DLO950DL01	white	37W	3050lm	82.43lm/w	5000K	36°	Ø200mm
● 613098	ILS37DLO930WW02	black	37W	2700lm	72.97lm/w	3000K	36°	Ø200mm
● 613099	ILS37DLO940NW02	black	37W	2900lm	78.39lm/w	4000K	36°	Ø200mm
● 613100	ILS37DLO950DL02	black	37W	3050lm	82.43lm/w	5000K	36°	Ø200mm
● 613101	ILS55DLO930WW01	white	55W	4000lm	72.73lm/w	3000K	36°	Ø200mm
● 613102	ILS55DLO940NW01	white	55W	4300lm	78.18lm/w	4000K	36°	Ø200mm
● 613103	ILS55DLO950DL01	white	55W	4500lm	81.82lm/w	5000K	36°	Ø200mm
● 613104	ILS55DLO930WW02	black	55W	4000lm	72.73lm/w	3000K	36°	Ø200mm
● 613105	ILS55DLO940NW02	black	55W	4300lm	78.18lm/w	4000K	36°	Ø200mm
● 613106	ILS55DLO950DL02	black	55W	4500lm	81.82lm/w	5000K	36°	Ø200mm



SMD

CloudWhite

Technical Operating & Electrical Data

Input Voltage & Frequency	AC220-240V, 50/60Hz
IP Ratings	IP44
Body Material	Aluminum
Mounting Type	Recessed in Ceiling
Dimming	Non-Dimmable
Life Span	50000h
CRI	90

Areas of Application

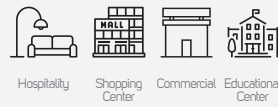

Family Product List

Code No.	Model No.	Power	Lumen	Efficacy	CCT	Beam Angle
613132	ILS7DL930WW02	7W	510lm	72.86lm/W	3000K	90°
613133	ILS7DL940NW02	7W	520lm	74.29lm/W	4000K	90°
613134	ILS7DL957DL02	7W	540lm	77.14lm/W	5700K	90°
613135	ILS10DL930WW02	10W	820lm	82lm/W	3000K	90°
613136	ILS10DL940NW02	10W	840lm	84lm/W	4000K	90°
613137	ILS10DL957DL02	10W	870lm	87lm/W	5700K	90°
613138	ILS15DL930WW02	15W	1250lm	83.33lm/W	3000K	90°
613139	ILS15DL940NW02	15W	1280lm	85.33lm/W	4000K	90°
613140	ILS15DL957DL02	15W	1320lm	88lm/W	5700K	90°
613141	ILS24DL930WW02	23W	2000lm	86.96lm/W	3000K	90°
613142	ILS24DL940NW02	23W	2040lm	88.70lm/W	4000K	90°
613143	ILS24DL957DL02	23W	2100lm	91.30lm/W	5700K	90°
613144	ILS36DL930WW02	35W	2950lm	84.29lm/W	3000K	90°
613145	ILS36DL940NW02	35W	3000lm	85.71lm/W	4000K	90°
613146	ILS36DL957DL02	35W	3060lm	87.43lm/W	5700K	90°

Driver

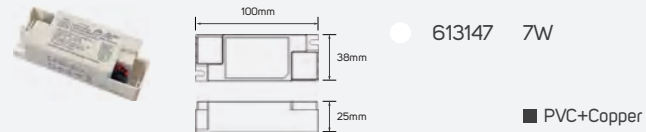

Driver

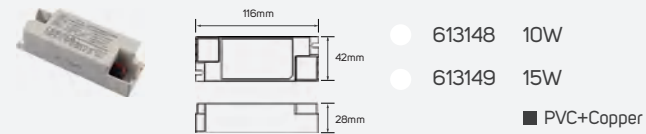

Driver

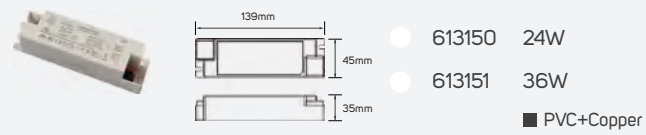

Dimensions Options

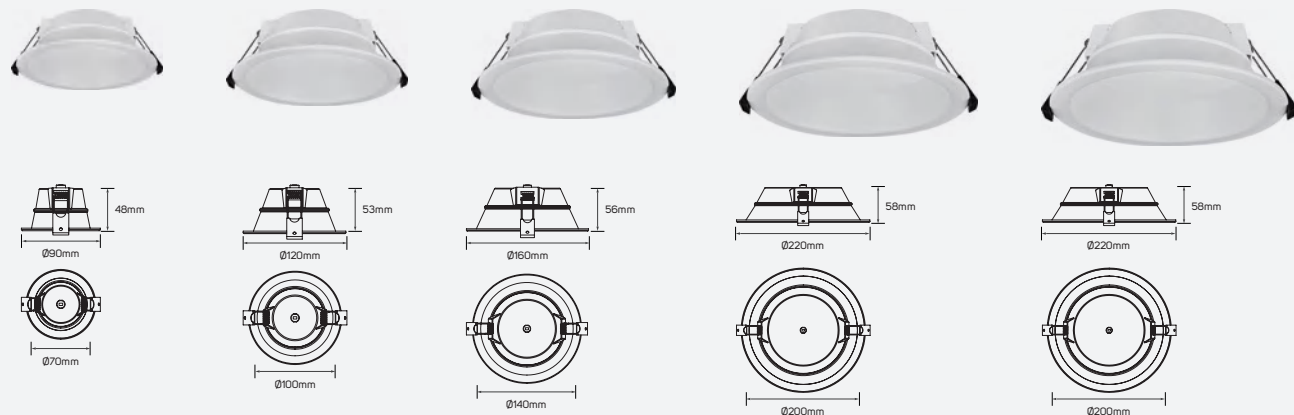

Aurora

Technical Operating & Electrical Data

Input Voltage & Frequency	AC220-240V, 50/60Hz
IP Ratings	IP20
Body Material	PA+PC
Mounting Type	Recessed in Ceiling
Dimming	Non-Dimmable
CCT	CCT-ADJUSTABLE, 3K-4K-6K
Life Span	15000h
CRI	95
Beam Angle	90°

Areas of Application

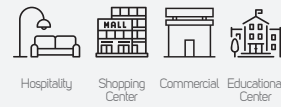

Family Product List

Code No.	Model No.	Power	Lumen
614170	ILS7WRDL304065K01	7W	3K@550lm-4K@590lm-6K@560lm
614171	ILS10WRDL304065K01	9.5W	3K@820lm-4K@880lm-6K@840lm
614172	ILS15WRDL304065K01	15W	3K@1300lm-4K@1420lm-6K@1350lm
614173	ILS24WRDL304065K01	20W	3K@1620lm-4K@1750lm-6K@1650lm
614174	ILS30WRDL304065K01	26W	3K@2000lm-4K@2250lm-6K@2100lm

Reflector

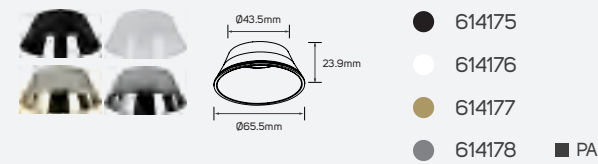

Reflector

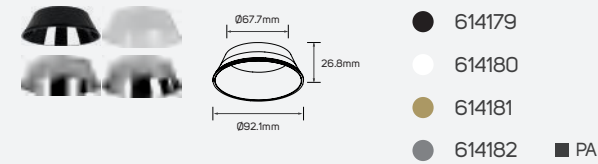

Reflector

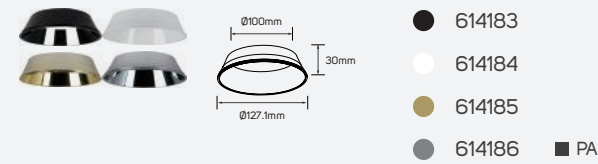

Reflector

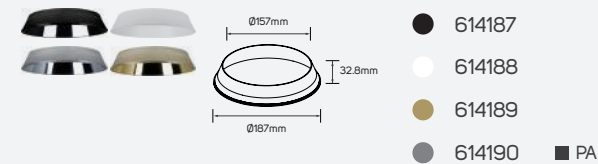

Dimensions Options

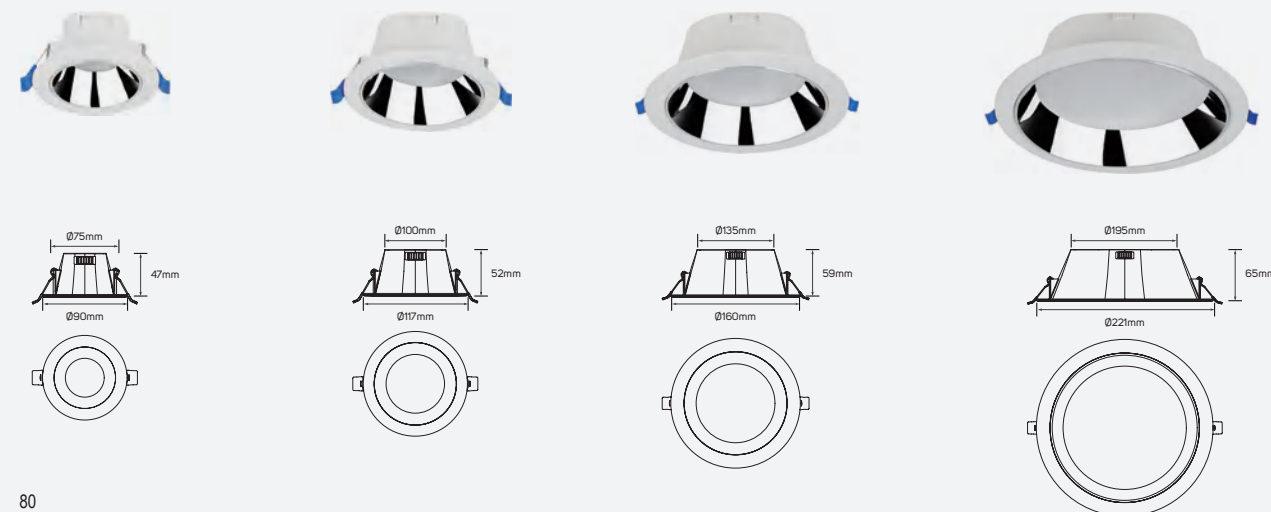

Economic SMD with PMMA Cover

Areas of Application

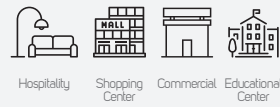

QuietSky

Technical Operating & Electrical Data

Input Voltage & Frequency	AC220-240V, 50/60Hz
Rated CRI	90
Beam Angle	90°
Life Span	30000h
Ingress Protection Rating	IP20
Dimming	Non-Dimmable
Switching Cycle ON/OFF	100,000



Dimensions Options

■ Plastic

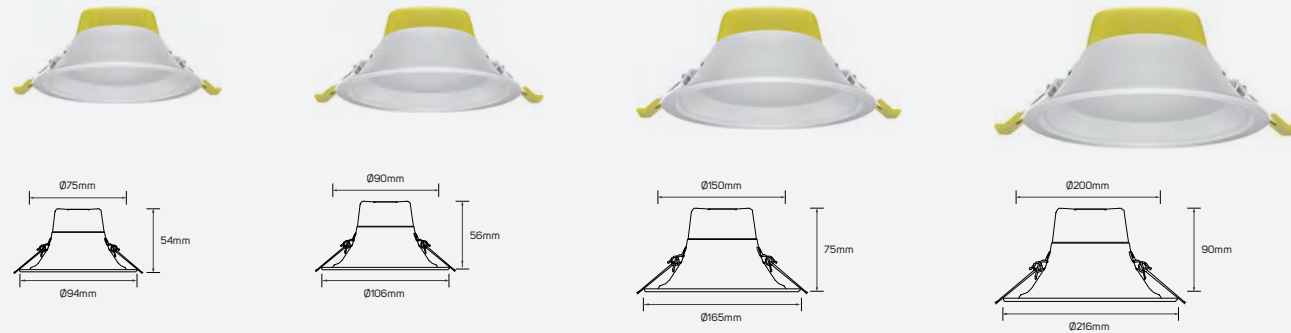

Family Product List

Code No.	Model No.	Power	Lumen	Efficacy	CCT	Current
612313	ILS5.6RCL930WW01	5.6 W	465lm	83lm/W	3000K	29 mA
612314	ILS5.6RCL940NW01	5.6 W	480lm	86lm/W	4000K	30 mA
612315	ILS5.6RCL950DL01	5.6 W	490lm	88lm/W	5000K	30 mA
612316	ILS7.8RCL930WW01	7.8 W	660lm	85lm/W	3000K	39 mA
612317	ILS7.8RCL940NW01	7.8 W	680lm	87lm/W	4000K	39 mA
612318	ILS7.8RCL950DL01	7.8 W	700lm	90lm/W	5000K	39 mA
612319	ILS16RCL930WW01	16 W	1280lm	80lm/W	3000K	78 mA
612320	ILS16RCL940NW01	16 W	1330lm	83lm/W	4000K	79 mA
612321	ILS16RCL950DL01	16 W	1350lm	84lm/W	5000K	79 mA
612322	ILS24RCL930WW01	24 W	1950lm	81lm/W	3000K	112 mA
612323	ILS24RCL940NW01	24 W	1990lm	83lm/W	4000K	115 mA
612324	ILS24RCL950DL01	24 W	2100lm	88lm/W	5000K	115 mA

Economic SMD with PMMA Cover

Areas of Application



QuietSky

Technical Operating & Electrical Data

Input Voltage & Frequency	AC220-240V, 50/60Hz
Rated CRI	90
Beam Angle	90°
Life Span	30000h
Ingress Protection Rating	IP20
Dimming	Non-Dimmable
Switching Cycle ON/OFF	100,000



Dimensions Options

■ Plastic

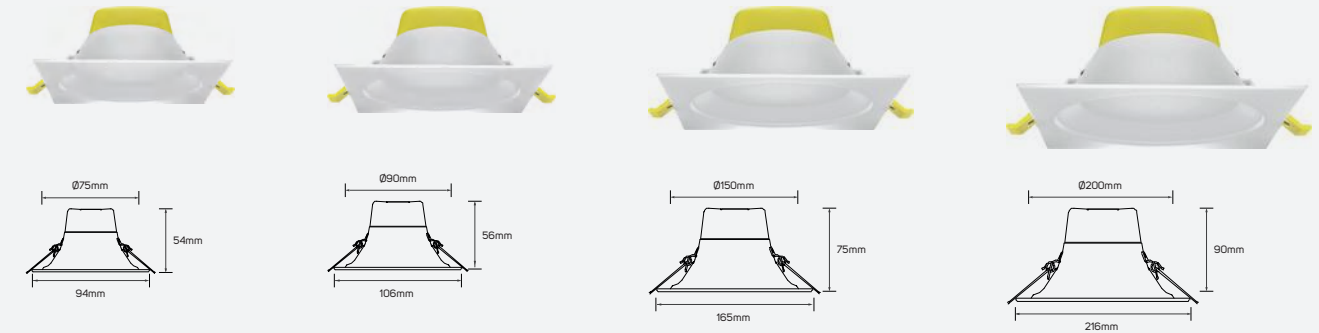

Family Product List

Code No.	Model No.	Power	Lumen	Efficacy	CCT	Current
612337	ILS5.6RCL930WW03	5.6W	465lm	83lm/W	3000K	29 mA
612338	ILS5.6RCL940NW03	5.6W	480lm	86lm/W	4000K	30 mA
612339	ILS5.6RCL950DL03	5.6W	490lm	88lm/W	5000K	30 mA
612340	ILS7.8RCL930WW02	7.8W	660lm	85lm/W	3000K	39 mA
612341	ILS7.8RCL940NW02	7.8W	680lm	87lm/W	4000K	39 mA
612342	ILS7.8RCL950DL02	7.8W	700lm	90lm/W	5000K	39 mA
612343	ILS16RCL930WW03	16W	1280lm	80lm/W	3000K	78 mA
612344	ILS16RCL940NW03	16W	1330lm	83lm/W	4000K	79 mA
612345	ILS16RCL950DL03	16W	1350lm	84lm/W	5000K	79 mA
612346	ILS24RCL930WW03	24W	1950lm	81lm/W	3000K	112 mA
612347	ILS24RCL940NW03	24W	1990lm	83lm/W	4000K	115 mA
612348	ILS24RCL950DL03	24W	2100lm	88lm/W	5000K	115 mA



SMD+Reflector

Areas of Application

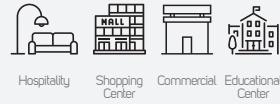

Chasing Shadows

Technical Operating & Electrical Data

Input Voltage & Frequency	AC220-240V, 50/60Hz
Rated CRI	90
Beam Angle	70°
Life Span	30000h
Ingress Protection Rating	IP20
Dimming	Non-Dimmable
Switching Cycle ON/OFF	100,000



Dimensions Options

■ Plastic



Family Product List

Code No.	Model No.	Power	Lumen	Efficacy	CCT	Current
612325	ILS5.6RCL930WW02	5.6W	420lm	75lm/W	3000K	29 mA
612326	ILS5.6RCL940NW02	5.6W	440lm	79lm/W	4000K	27 mA
612327	ILS5.6RCL950DL02	5.6W	450lm	80lm/W	5000K	29 mA
612328	ILS8RCL930WW01	8W	600lm	75lm/W	3000K	39 mA
612329	ILS8RCL940NW01	8W	630lm	79lm/W	4000K	40 mA
612330	ILS8RCL950DL01	8W	640lm	80lm/W	5000K	40 mA
612331	ILS16RCL930WW02	16W	1180lm	74lm/W	3000K	78 mA
612332	ILS16RCL940NW02	16W	1230lm	77lm/W	4000K	80 mA
612333	ILS16RCL950DL02	16W	1250lm	78lm/W	5000K	80 mA
612334	ILS24RCL930WW02	24W	1770lm	74lm/W	3000K	111 mA
612335	ILS24RCL940NW02	24W	1860lm	78lm/W	4000K	112 mA
612336	ILS24RCL950DL02	24W	1900lm	79lm/W	5000K	113 mA

SMD+Reflector

Areas of Application

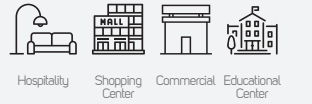

Chasing Shadows

Technical Operating & Electrical Data

Input Voltage & Frequency	AC220-240V, 50/60Hz
Rated CRI	90
Beam Angle	70°
Life Span	30000h
Ingress Protection Rating	IP20
Dimming	Non-Dimmable
Switching Cycle ON/OFF	100,000



Dimensions Options

■ Plastic

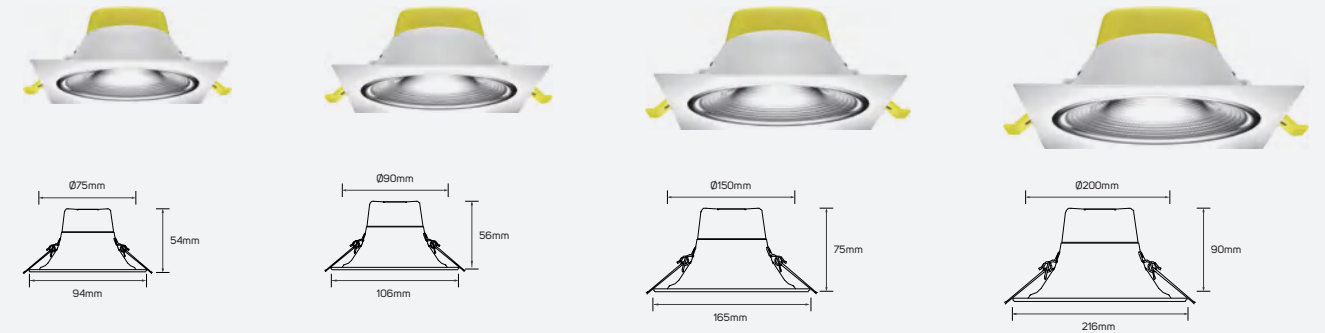

Family Product List

Code No.	Model No.	Power	Lumen	Efficacy	CCT	Current
612349	ILS5.6RCL930WW04	5.6W	420lm	75lm/W	3000K	29 mA
612350	ILS5.6RCL940NW04	5.6W	440lm	79lm/W	4000K	27 mA
612351	ILS5.6RCL950DL04	5.6W	450lm	80lm/W	5000K	29 mA
612352	ILS8RCL930WW02	8W	600lm	75lm/W	3000K	39 mA
612353	ILS8RCL940NW02	8W	630lm	79lm/W	4000K	40 mA
612354	ILS8RCL950DL02	8W	640lm	80lm/W	5000K	40 mA
612355	ILS16RCL930WW04	16W	1180lm	74lm/W	3000K	78 mA
612356	ILS16RCL940NW04	16W	1230lm	77lm/W	4000K	80 mA
612357	ILS16RCL950DL04	16W	1250lm	78lm/W	5000K	80 mA
612358	ILS24RCL930WW04	24W	1770lm	74lm/W	3000K	111 mA
612359	ILS24RCL940NW04	24W	1860lm	78lm/W	4000K	112 mA
612360	ILS24RCL950DL04	24W	1900lm	79lm/W	5000K	113 mA

Plastic DOB Downlight

Noan

Areas of Application

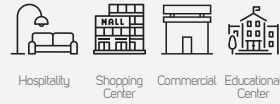

Technical Operating & Electrical Data

Input Voltage & Frequency	AC220-240V, 50/60Hz
Rated CRI	90
Beam Angle	90°
Life Span	35000h
Ingress Protection Rating	IP20
Dimming	Non-Dimmable
Switching Cycle ON/OFF	100,000



Dimensions Options

■ Plastic

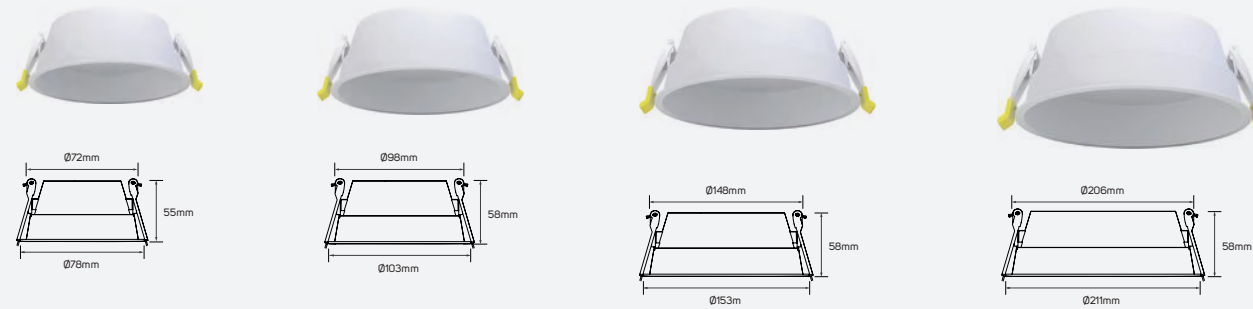

Family Product List

Code No.	Model No.	Power	Lumen	Efficacy	CCT	Current
612361	ILS6.8RCL930WW01	6.8W	510lm	75lm/W	3000K	34 mA
612362	ILS6.8RCL940NW01	6.8W	540lm	79lm/W	4000K	34 mA
612363	ILS6.8RCL950DL01	6.8W	550lm	81lm/W	5000K	34 mA
612364	ILS9.8RCL930WW01	9.8W	810lm	83lm/W	3000K	43 mA
612365	ILS9.8RCL940NW01	9.8W	840lm	86lm/W	4000K	44 mA
612366	ILS9.8RCL950DL01	9.8W	870lm	89lm/W	5000K	43 mA
612367	ILS19RCL930WW01	19W	1790lm	94lm/W	3000K	88 mA
612368	ILS19RCL940NW01	19W	1850lm	97lm/W	4000K	88 mA
612369	ILS19RCL950DL01	19W	1870lm	98lm/W	5000K	88 mA
612370	ILS29RCL930WW01	29W	2450lm	84lm/W	3000K	120 mA
612371	ILS29RCL940NW01	29W	2550lm	88lm/W	4000K	119 mA
612372	ILS29RCL950DL01	29W	2600lm	90lm/W	5000K	121 mA

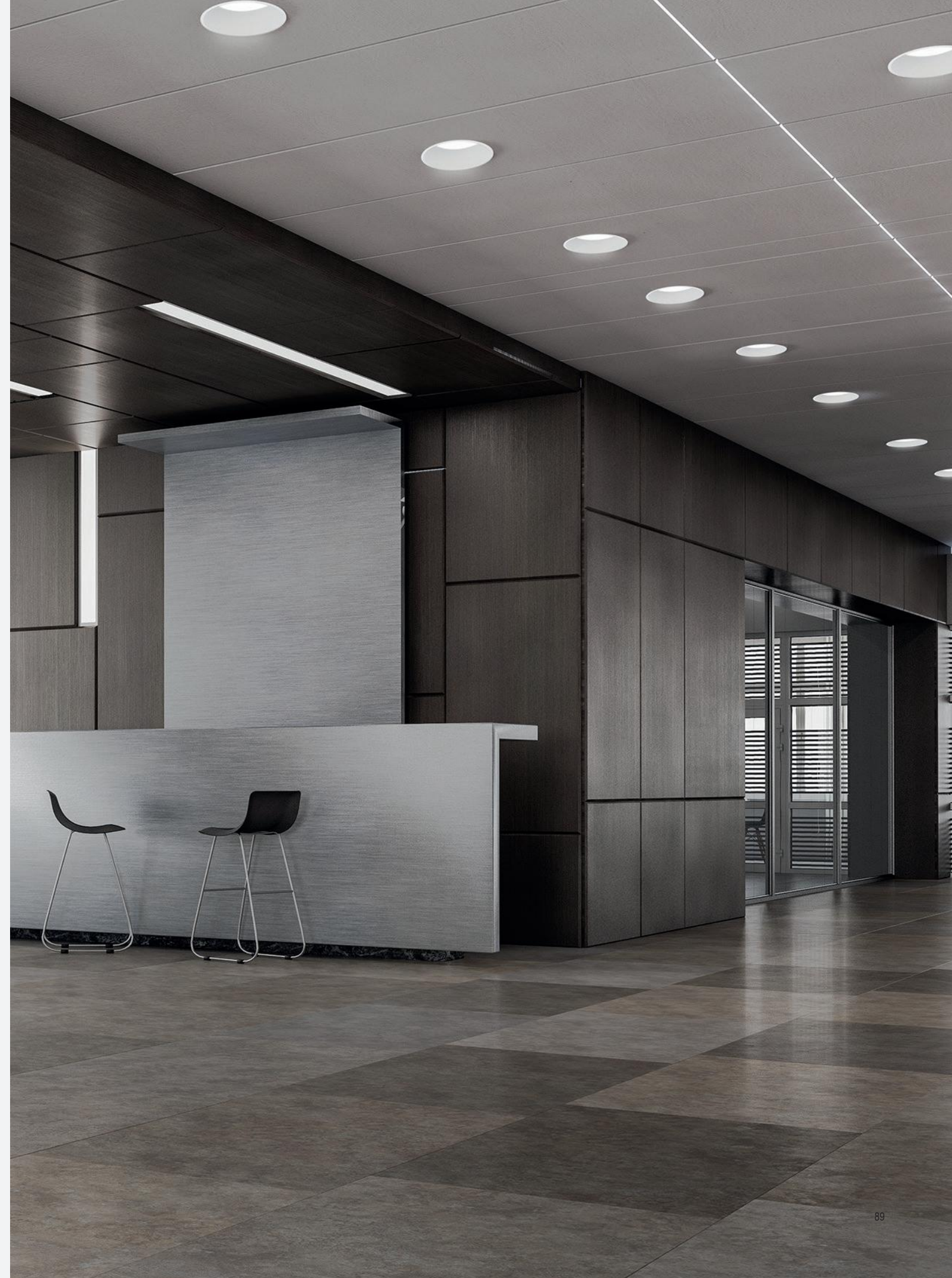

Mini Downlight

Starry

Technical Operating & Electrical Data

Input Voltage & Frequency	AC220-240V, 50/60Hz
IP Ratings	IP20
Body Material	Die Casting Aluminum
Mounting Type	Recessed in Ceiling
Dimming	Non-Dimmable
Life Span	30000h

Areas of Application

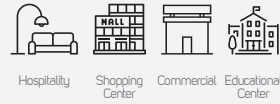

Dimensions Options

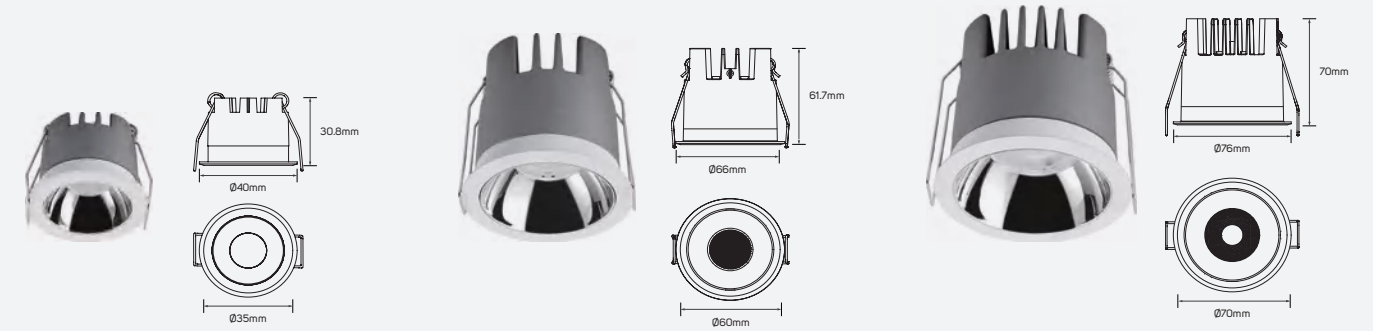

Reflector

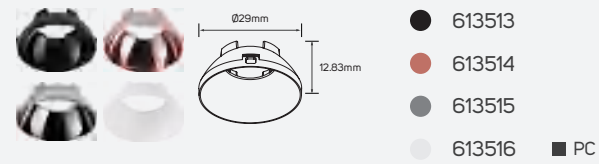

Reflector

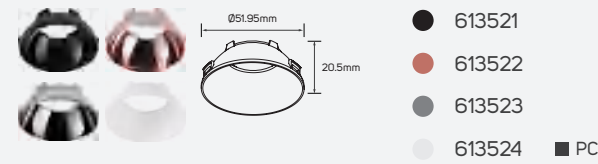

Reflector

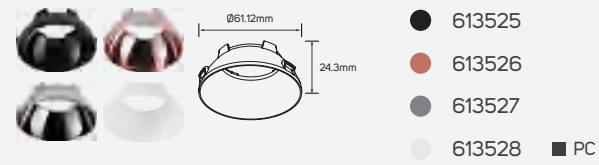

Frame

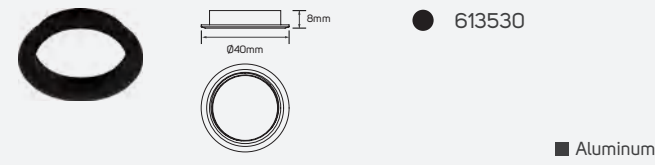

Frame

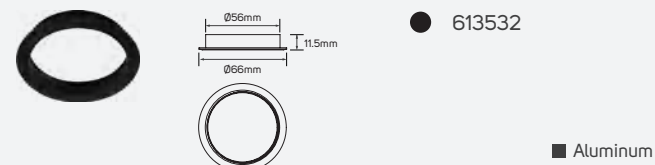

Frame

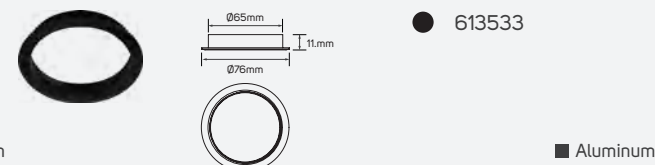

Lens

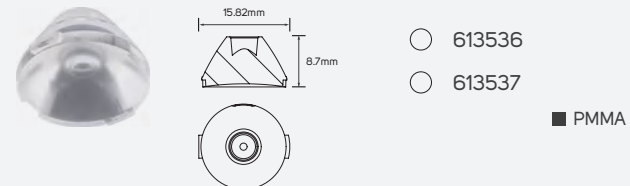

Lens

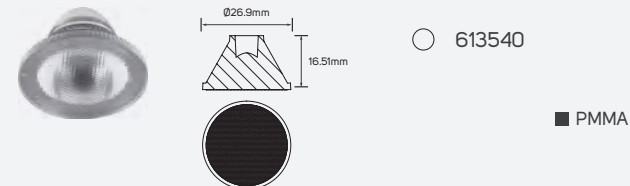

Lens

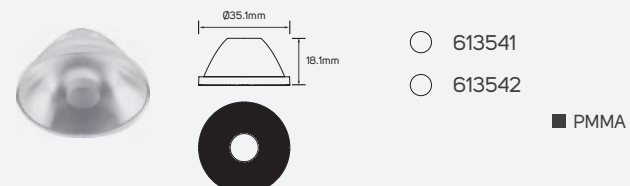

Family Product List

■ Die Casting Aluminum

Code No.	Model No.	Power	Lumen	Efficacy	CCT	Beam Angle
● 613497	ILS3MDL930WW01	3W	195lm	65lm/W	3000K	24°
● 613498	ILS3MDL940NW01	3W	205lm	68.33lm/W	4000K	24°
● 613499	ILS3MDL950DL01	3W	220lm	73.33lm/W	5000K	24°
● 613500	ILS8MDL930WW01	4.5W	350lm	77.78lm/W	3000K	24°
● 613501	ILS4.5MDL940NW01	4.5W	360lm	80lm/W	4000K	24°
● 613502	ILS4.5MDL950DL01	4.5W	380lm	84.44lm/W	5000K	24°
● 613503	ILS4.5MDL930WW01	8W	570lm	71.25lm/W	3000K	24°
● 613504	ILS8MDL940NW01	8W	590lm	73.75lm/W	4000K	24°
● 613505	ILS8MDL950DL01	8W	620lm	77.5lm/W	5000K	24°
● 613506	ILS12.5MDL930WW01	12.5W	970lm	77.6lm/W	3000K	24°
● 613507	ILS12.5MDL940NW01	12.5W	1000lm	80lm/W	4000K	24°
● 613508	ILS12.5MDL950DL01	12.5W	1050lm	84lm/W	5000K	24°



Mini Downlight

Starry

Technical Operating & Electrical Data

Input Voltage & Frequency	AC220-240V, 50/60Hz
IP Ratings	IP20
Body Material	Aluminum
Mounting Type	Recessed in Ceiling
Dimming	Non-Dimmable
Life Span	25000h

Areas of Application

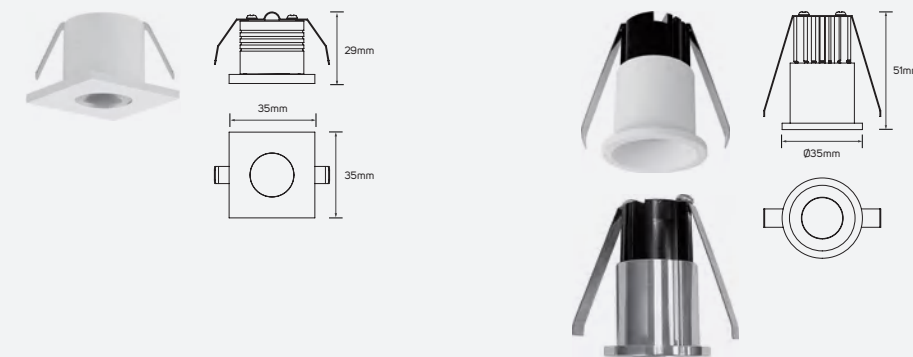
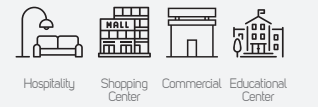

Mini Downlight

PRODUCT INFORMATION

- Suitable for a series of lighting applications in office, retail and general area lighting.
- Available in a wide variety of lumen packs, cut out size and color temperature.
- ILLUS LED RECESSED Luminaire gives the customer the flexibility to choose between 9 models based on their specific need with lumen package from 195 lm to 1050 lm.

BENEFITS

- Compact design for better integration with the building.
- Comfortable light with high efficiency.
- Reliable performance for indoor applications.

FEATURES

- High CRI>90.
- Efficacy up to 80lm/w.
- Long life span 25,000 hrs.
- Operating voltage AC220 – 240V.
- Non – dimmable.

Code No.	Power	CCT	Lumen		Code No.	Power	CCT	Lumen	
5101261	2.8W	3000K	175lm	CRI 90	5101265	3.5W	3000K	215lm	CRI 95
5101262	2.8W	5700K	175lm		5101266	3.5W	5700K	215lm	
5101263	2.8W	3000K	175lm		5101267	3.5W	3000K	215lm	
5101264	2.8W	5700K	175lm		5101268	3.5W	5700K	215lm	

- Aluminum
- IP 20
- 24°
- AC220-240V
- 25,000h

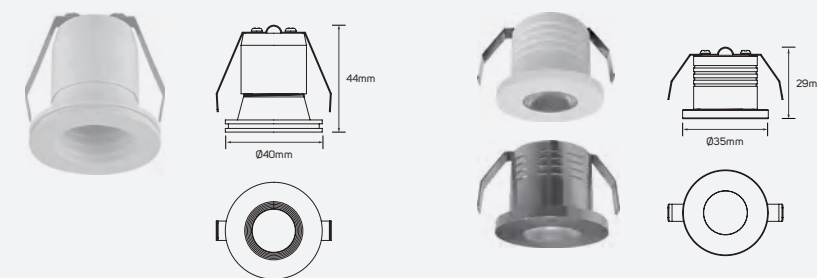

Code No.	Power	CCT	Lumen		Code No.	Power	CCT	Lumen	
5101255	3.5W	3000K	215lm		5101257	2.8W	3000K	175lm	CRI 90
5101256	3.5W	5700K	215lm		5101258	2.8W	5700K	175lm	
					5101259	2.8W	3000K	175lm	
					5101260	2.8W	5700K	175lm	



LED Recessed Ceiling Luminaire

ModernStylish

Areas of Application



Technical Operating & Electrical Data

Input Voltage & Frequency	AC220-240V, 50/60Hz
IP Ratings	IP20
Body Material	Aluminum
Rated CRI	95
Dimming	Non-Dimmable
Life Span	30000h
Beam Angle	24°

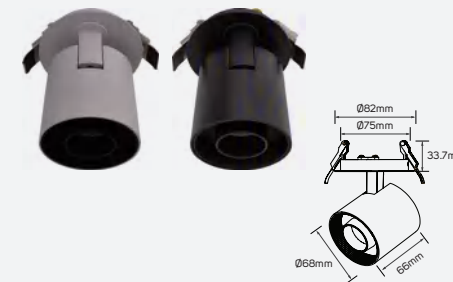

LED Recessed Ceiling Luminaire

PRODUCT INFORMATION

- Suitable for a series of lighting applications in office, retail and general area lighting.
- Available in a wide variety of lumen packs, cut out size and color temperature.
- ILLUS LED RECESSED CEILING Luminaire gives the customer the flexibility to choose between 16 models based on their specific need with lumen package from 460lm to 2550lm.

BENEFITS

- Compact design for better integration with the building.
- Comfortable light with high efficiency.
- Reliable performance for indoor applications.

FEATURES

- High CRI>95.
- Long life span 30,000 hrs.
- Operating voltage AC220 – 240V.
- Non – dimmable.

Family Product List

Code No.	Model No.	Power	Lumen	Efficacy	CCT	Body Color
613802	ILS6WRSL930WW01	6.5W	460lm	70.77lm/w	3000K	White + Black
613803	ILS6WRSL930WW02	6.5W	460lm	70.77lm/w	3000K	Black
613804	ILS6WRSL940NW01	6.5W	470lm	72.31lm/w	4000K	White + Black
613805	ILS6WRSL940NW02	6.5W	470lm	72.31lm/w	4000K	Black
613808	ILS12WRSL930WW01	12W	900lm	75lm/w	3000K	White + Black
613809	ILS12WRSL930WW02	12W	900lm	75lm/w	3000K	Black
613810	ILS12WRSL940NW01	12W	920lm	76.67lm/w	4000K	White + Black
613811	ILS12WRSL940NW02	12W	920lm	76.67lm/w	4000K	Black
613814	ILS24WRSL930WW01	24W	1680lm	70lm/w	3000K	White + Black
613815	ILS24WRSL930WW02	24W	1680lm	70lm/w	3000K	Black
613816	ILS24WRSL940NW01	24W	1720lm	71.67lm/w	4000K	White + Black
613817	ILS24WRSL940NW02	24W	1720lm	71.67lm/w	4000K	Black
613820	ILS35WRSL930WW01	35W	2500lm	71.43lm/w	3000K	White + Black
613821	ILS35WRSL930WW02	35W	2500lm	71.43lm/w	3000K	Black
613822	ILS35WRSL940NW01	35W	2550lm	72.86lm/w	4000K	White + Black
613823	ILS35WRSL940NW02	35W	2550lm	72.86lm/w	4000K	Black

LED Recessed Ceiling Luminaire

Areas of Application

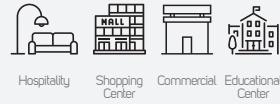

Keroro

Technical Operating & Electrical Data

Input Voltage & Frequency	AC220-240V, 50/60Hz
IP Ratings	IP20
Body Material	Aluminum
Rated CRI	95
Dimming	Non-Dimmable
Life Span	30000h
Beam Angle	24°

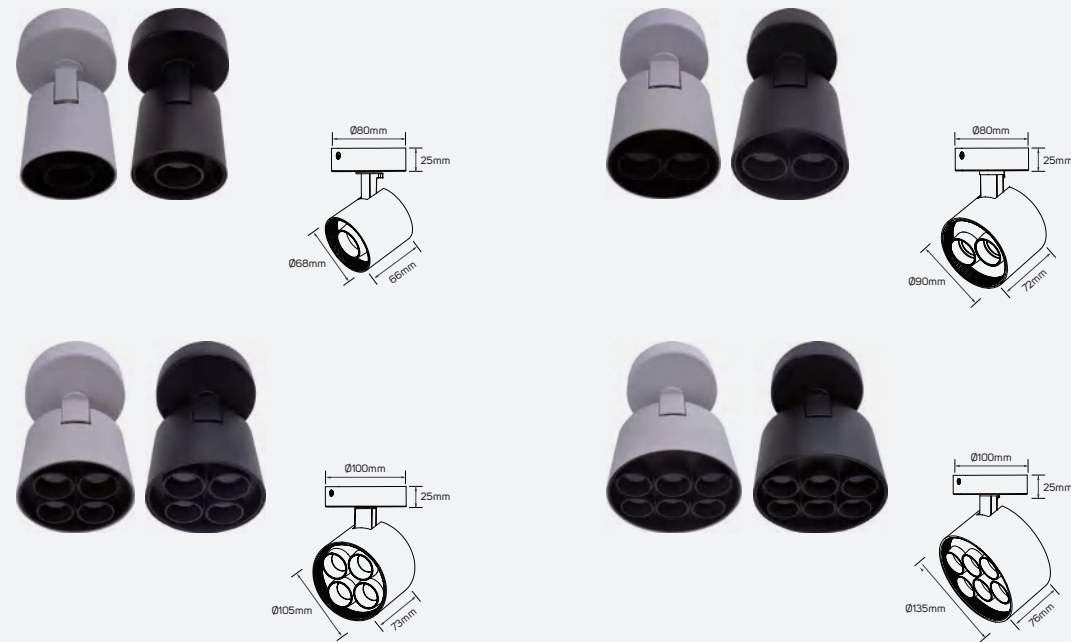

Family Product List

Code No.	Model No.	Power	Lumen	Efficacy	CCT	Body Color
▶ 613778	ILS6WSMSL930WW01	6.5W	460lm	70.77lm/w	3000K	White + Black
● 613779	ILS6WSMSL930WW02	6.5W	460lm	70.77lm/w	3000K	Black
▶ 613780	ILS6WSMSL940NW01	6.5W	470lm	72.31lm/w	4000K	White + Black
● 613781	ILS6WSMSL940NW02	6.5W	470lm	72.31lm/w	4000K	Black
▶ 613784	ILS12WSMSL930WW01	12W	900lm	75lm/w	3000K	White + Black
● 613785	ILS12WSMSL930WW02	12W	900lm	75lm/w	3000K	Black
▶ 613786	ILS12WSMSL940NW01	12W	920lm	76.67lm/w	4000K	White + Black
● 613787	ILS12WSMSL940NW02	12W	920lm	76.67lm/w	4000K	Black
▶ 613790	ILS24WSMSL930WW01	24W	1680lm	70lm/w	3000K	White + Black
● 613791	ILS24WSMSL930WW02	24W	1680lm	70lm/w	3000K	Black
▶ 613792	ILS24WSMSL940NW01	24W	1720lm	71.67lm/w	4000K	White + Black
● 613793	ILS24WSMSL940NW02	24W	1720lm	71.67lm/w	4000K	Black
▶ 613796	ILS35WSMSL930WW01	35W	2500lm	71.43lm/w	3000K	White + Black
● 613797	ILS35WSMSL930WW02	35W	2500lm	71.43lm/w	3000K	Black
▶ 613798	ILS35WSMSL940NW01	35W	2550lm	72.86lm/w	4000K	White + Black
● 613799	ILS35WSMSL940NW02	35W	2550lm	72.86lm/w	4000K	Black

LED Recessed Ceiling Luminaire

Areas of Application

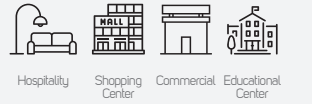

Glorya

Technical Operating & Electrical Data

Input Voltage & Frequency	AC220-240V, 50/60Hz
IP Ratings	IP20
Body Material	Aluminum
Rated CRI	95
Dimming	Non-Dimmable
Life Span	30000h
Beam Angle	24°

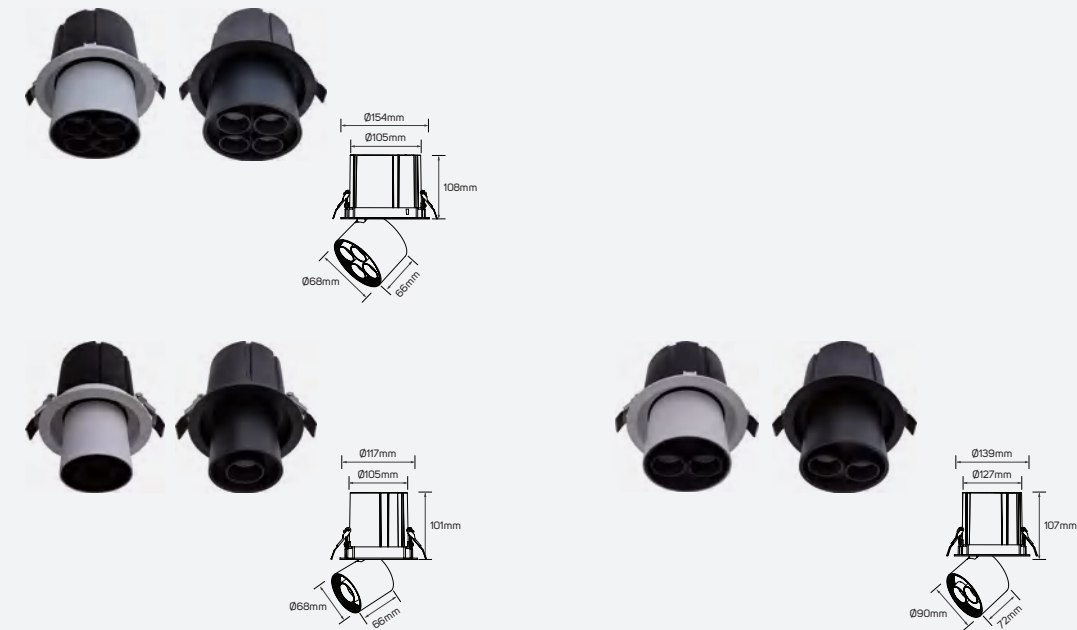

Family Product List

Code No.	Model No.	Power	Lumen	Efficacy	CCT	Body Color
▶ 613826	ILS6WPPRSL930WW01	6.5W	460lm	70.77lm/w	3000K	White + Black
● 613827	ILS6WPPRSL930WW02	6.5W	460lm	70.77lm/w	3000K	Black
▶ 613828	ILS6WPPRSL940NW01	6.5W	470lm	72.31lm/w	4000K	White + Black
● 613829	ILS6WPPRSL940NW02	6.5W	470lm	72.31lm/w	4000K	Black
▶ 613832	ILS12WPPRSL930WW01	12W	900lm	75lm/w	3000K	White + Black
● 613833	ILS12WPPRSL930WW02	12W	900lm	75lm/w	3000K	Black
▶ 613834	ILS12WPPRSL940NW01	12W	920lm	76.67lm/w	4000K	White + Black
● 613835	ILS12WPPRSL940NW02	12W	920lm	76.67lm/w	4000K	Black
▶ 613838	ILS24WPPRSL930WW01	24W	1680lm	70lm/w	3000K	White + Black
● 613839	ILS24WPPRSL930WW02	24W	1680lm	70lm/w	3000K	Black
▶ 613840	ILS24WPPRSL940NW01	24W	1720lm	71.67lm/w	4000K	White + Black
● 613841	ILS24WPPRSL940NW02	24W	1720lm	71.67lm/w	4000K	Black



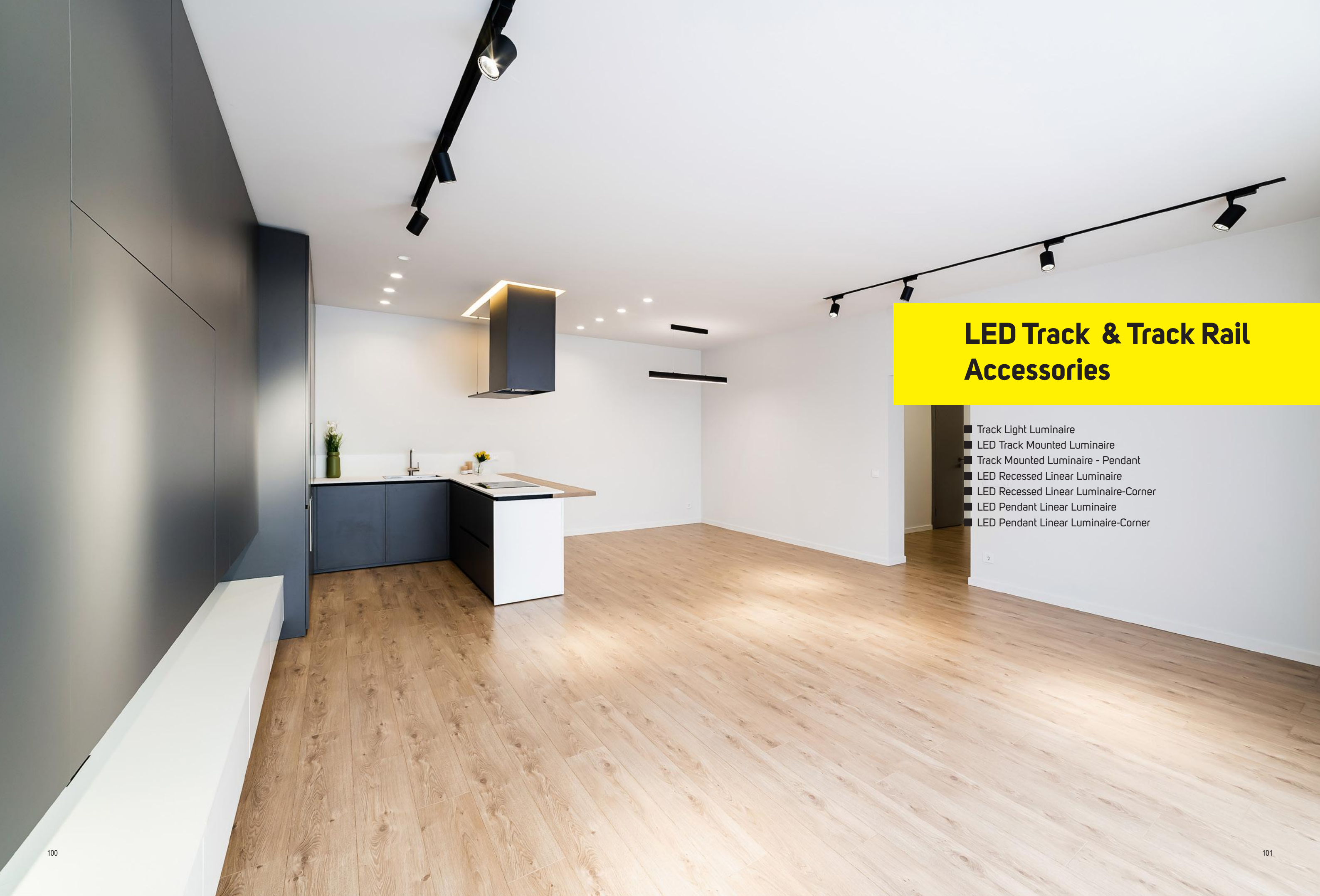

LED Track & Track Rail Accessories

- Track Light Luminaire
- LED Track Mounted Luminaire
- Track Mounted Luminaire - Pendant
- LED Recessed Linear Luminaire
- LED Recessed Linear Luminaire-Corner
- LED Pendant Linear Luminaire
- LED Pendant Linear Luminaire-Corner



Track Light Luminaire

Track Light Luminaire

Artist-Romanticism

Technical Operating & Electrical Data

Input Voltage & Frequency	AC220-240V, 50/60Hz
IP Ratings	IP20
Body Material	Aluminum
Cap Type	GU10
Mounting Type	Mounted on Track
Type of Frame	Adjustable

Areas of Application

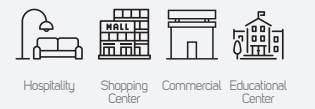

Reflector

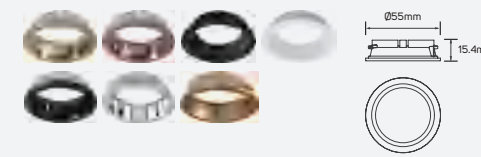

- 5101664
- 5101665
- 5101666
- 5101667
- 5101668
- 5101669
- 5101670
- PC

Dimensions Options

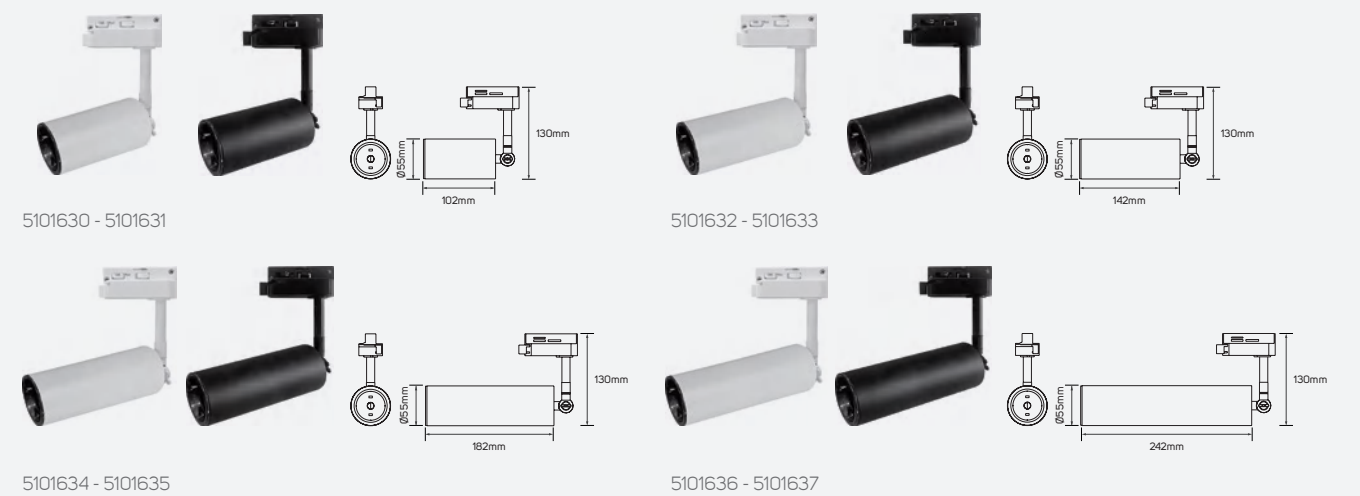

Dimensions Options

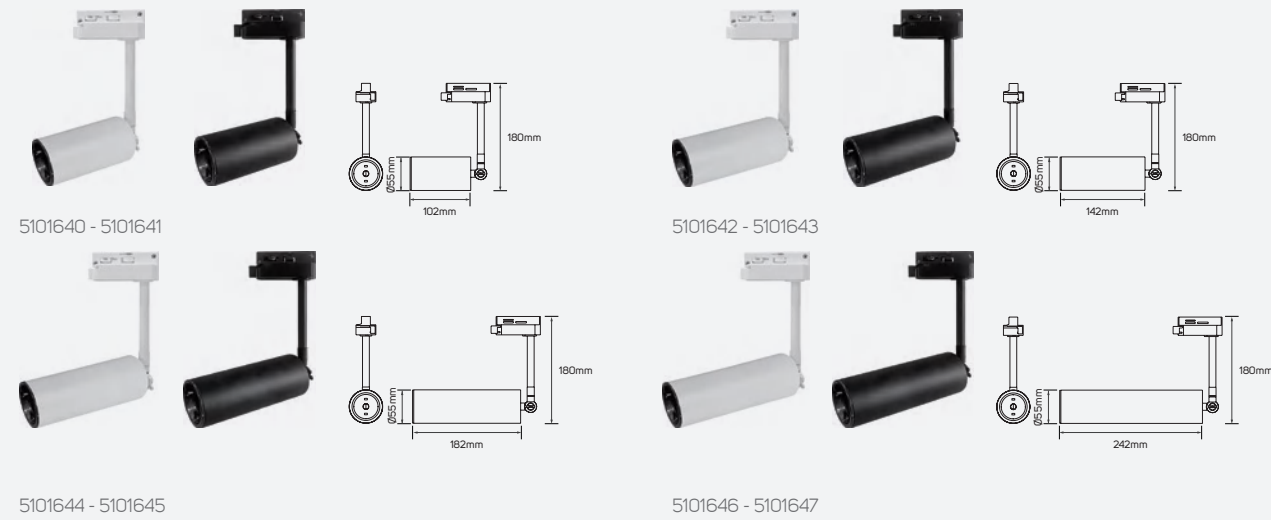

Track Light Luminaire

Artist-Surrealism

Technical Operating & Electrical Data

Input Voltage & Frequency	AC220-240V, 50/60Hz
IP Ratings	IP20
Body Material	Aluminum
Cap Type	GU10
Mounting Type	Mounted on Track
Type of Frame	Adjustable

Areas of Application

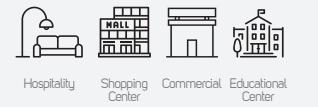

Reflector

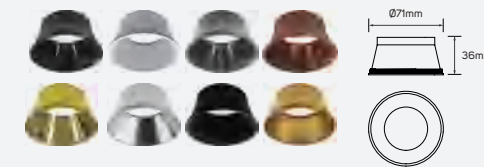

● 5101324	● 5101660
● 5101325	● 5101661
● 5101326	● 5101662
● 5101327	● 5101663

■ Aluminum

Family Product List

Code No.	Model No.	Max. Wattage	Body Color	Body Material
● 5101630	ILSATMF44	Max.9W	white	aluminum
● 5101631	ILSATMF44	Max.9W	matt black	aluminum
● 5101632	ILSATMF45	Max.9W	white	aluminum
● 5101633	ILSATMF45	Max.9W	matt black	aluminum
● 5101634	ILSATMF46	Max.9W	white	aluminum
● 5101635	ILSATMF46	Max.9W	matt black	aluminum
● 5101636	ILSATMF47	Max.9W	white	aluminum
● 5101637	ILSATMF47	Max.9W	matt black	aluminum
● 5101640	ILSATMF49	Max.9W	white	aluminum
● 5101641	ILSATMF49	Max.9W	matt black	aluminum
● 5101642	ILSATMF50	Max.9W	white	aluminum
● 5101643	ILSATMF50	Max.9W	matt black	aluminum
● 5101644	ILSATMF51	Max.9W	white	aluminum
● 5101645	ILSATMF51	Max.9W	matt black	aluminum
● 5101646	ILSATMF52	Max.9W	white	aluminum
● 5101647	ILSATMF52	Max.9W	matt black	aluminum

Dimensions Options

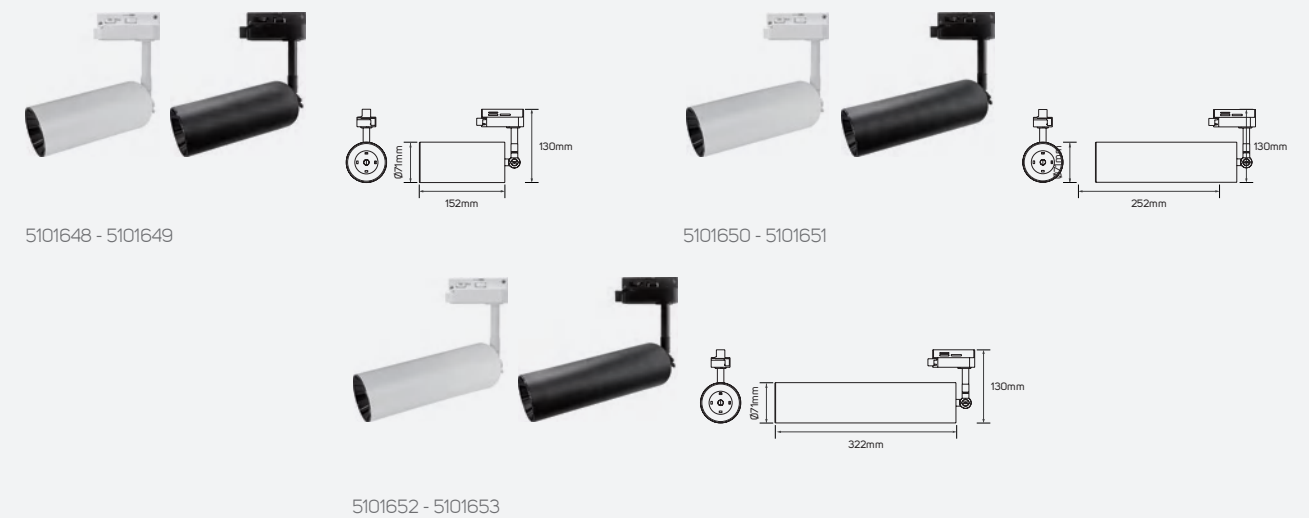

Dimensions Options



5101654 - 5101655

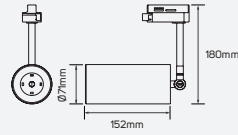

5101656 - 5101657

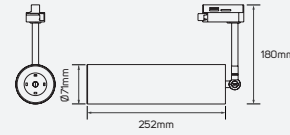

5101658 - 5101659



Family Product List

Code No.	Model No.	Max. Wattage	Body Color	Body Material
● 5101648	ILSATMF62	Max.9W	white	aluminum
● 5101649	ILSATMF62	Max.9W	matt black	aluminum
● 5101650	ILSATMF63	Max.9W	white	aluminum
● 5101651	ILSATMF63	Max.9W	matt black	aluminum
● 5101652	ILSATMF64	Max.9W	white	aluminum
● 5101653	ILSATMF64	Max.9W	matt black	aluminum
● 5101654	ILSATMF65	Max.9W	white	aluminum
● 5101655	ILSATMF65	Max.9W	matt black	aluminum
● 5101656	ILSATMF66	Max.9W	white	aluminum
● 5101657	ILSATMF66	Max.9W	matt black	aluminum
● 5101658	ILSATMF67	Max.9W	white	aluminum
● 5101659	ILSATMF67	Max.9W	matt black	aluminum



Track Light Luminaire

Areas of Application

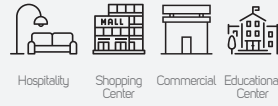

Artist-Impressionism

Technical Operating & Electrical Data

Input Voltage & Frequency	AC220-240V, 50/60Hz
IP Ratings	IP20
Body Material	Aluminum+Plastic
Cap Type	GU10
Mounting Type	Track Mounted
Type of Frame	Adjustable



612119 - 612120



612121 - 612122

Family Product List

Code No.	Model No.	Max. Wattage	Body Color	Code No.	Model No.	Max. Wattage	Body Color
612119	ILSATMF09	Max.9W	white+black	612121	ILSATMF10	Max.9W	white+black
612120	ILSATMF09	Max.9W	black	612122	ILSATMF10	Max.9W	black

Track Light Luminaire

Areas of Application



Artist-Fauvism

Technical Operating & Electrical Data

Input Voltage & Frequency	AC220-240V, 50/60Hz
IP Ratings	IP20
Body Material	Aluminum+Plastic
Cap Type	GU10
Mounting Type	Track Mounted
Type of Frame	Adjustable



612155 - 612156



612159 - 612160

Family Product List

Code No.	Model No.	Max. Wattage	Body Color	Code No.	Model No.	Max. Wattage	Body Color
612155	ILSATMF11	Max.9W	white+black	612159	ILSATMF13	Max.9W	white+black
612156	ILSATMF11	Max.9W	black	612160	ILSATMF13	Max.9W	black

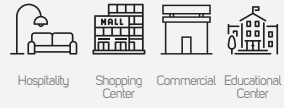

Artist-Futurism

Technical Operating & Electrical Data

Input Voltage & Frequency	AC220-240V, 50/60Hz
IP Ratings	IP20
Body Material	Aluminum+Plastic
Cap Type	GU10
Mounting Type	Track Mounted
Type of Frame	Adjustable



612157 - 612158

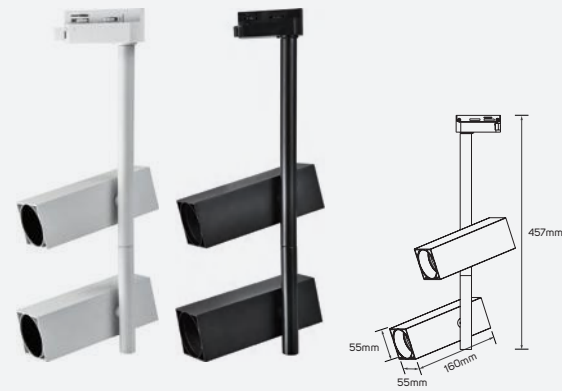

612161 - 612162

Family Product List

Code No.	Model No.	Max. Wattage	Body Color	Code No.	Model No.	Max. Wattage	Body Color
612157	ILSATMF12	Max.9W	white+black	612161	ILSATMF14	Max.9W	white+black
612158	ILSATMF12	Max.9W	black	612162	ILSATMF14	Max.9W	black

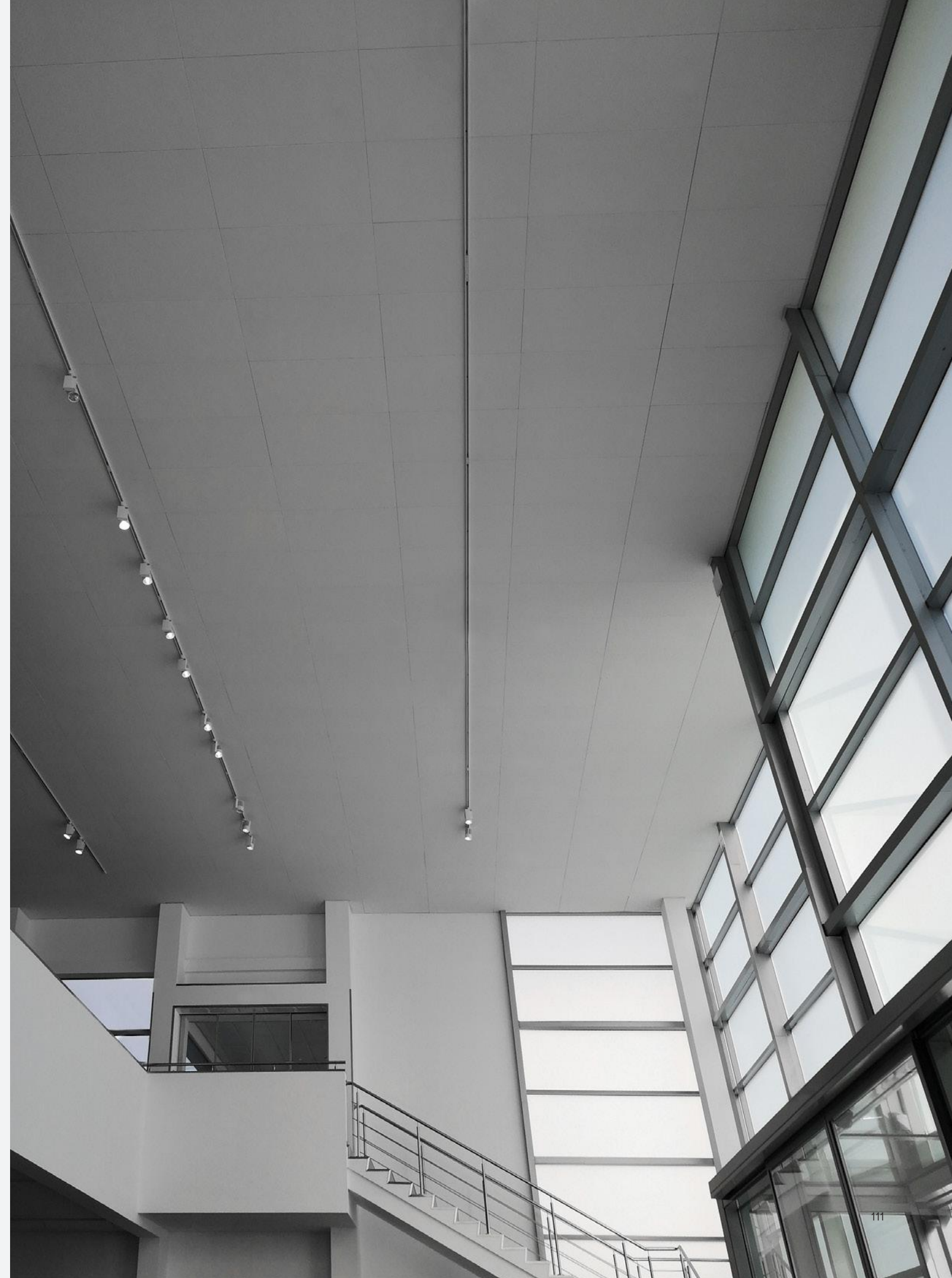



LED Track Mounted Luminaire

Dance of Elegance

Technical Operating & Electrical Data

Input Voltage & Frequency	AC220-240V, 50/60Hz
IP Ratings	IP20
Body Material	Aluminum+Plastic
CRI	95
Beam Angle	24°
Type of Frame	Adjustable
Life Span	30000h

Areas of Application



Lens

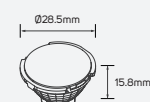

- 671262 ▼ 15°
- 671263 ▼ 50°
- PC

Honeycomb

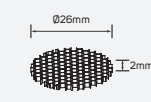

- 671261
- PC

LED Track Mounted Luminaire

PRODUCT INFORMATION

- Suitable for a series of lighting applications in retail and hospitality.
- Support retailers to let their products stand out or highlight certain objects.
- ILLUS LED TRACK-MOUNTED LUMINAIRE gives the customer the flexibility to choose between 12 models based on their specific need with lumen package from 950 lm to 2800 lm.

BENEFITS

- Reduced operating costs and longer lifetime.
- Unobtrusive design in white or black finish.
- Clean, simple finish to many interior designs.

FEATURES

- High CRI>95.
- Efficacy up to 93 lm/w.
- Long life span 50,000 hrs.
- Operating voltage AC220 - 240V.
- Non - dimmable.

Dimensions Options



671237 - 671238 - 671239 - 671240



671243 - 671244 - 671245 - 671246



671249 - 671250 - 671251 - 671252



671255 - 671256 - 671257 - 671258

Family Product List

Code No.	Model No.	Power	Lumen	Efficacy	CCT	Body Color
671237	ILS06TL930WW01	6.5W	460lm	80lm/W	3000K	white+black
671238	ILS06TL930WW02	6.5W	460lm	80lm/W	3000K	black
671239	ILS06TL940NW01	6.5W	470lm	80.9lm/W	4000K	white+black
671240	ILS06TL940NW02	6.5W	470lm	80.9lm/W	4000K	black
671243	ILS12TL930WW01	13W	900lm	90lm/W	3000K	white+black
671244	ILS12TL930WW02	13W	900lm	90lm/W	3000K	black
671245	ILS12TL940NW01	13W	920lm	93lm/W	4000K	white+black
671246	ILS12TL940NW02	13W	920lm	93lm/W	4000K	black
671249	ILS24TL930WW01	24W	1680lm	94.7lm/W	3000K	white+black
671250	ILS24TL930WW02	24W	1680lm	94.7lm/W	3000K	black
671251	ILS24TL940NW01	24W	1720lm	96.3lm/W	4000K	white+black
671252	ILS24TL940NW02	24W	1720lm	96.3lm/W	4000K	black
671255	ILS35TL930WW01	35W	2500lm	96.3lm/W	3000K	white+black
671256	ILS35TL930WW02	35W	2500lm	96.3lm/W	3000K	black
671257	ILS35TL940NW01	35W	2550lm	100lm/W	4000K	white+black
671258	ILS35TL940NW02	35W	2550lm	100lm/W	4000K	black

LED Track Mounted Luminaire

Moonlight Sonata

Technical Operating & Electrical Data

Input Voltage & Frequency	AC220-240V, 50/60Hz
IP Ratings	IP20
Body Material	Aluminum+Plastic
CRI	92
Beam Angle	24°
Type of Frame	Adjustable
Life Span	30000h



611769 - 611770 - 611771 - 611772



61173 - 611774 - 611775 - 611776



61177 - 611778 - 611779 - 611780

Areas of Application



Family Product List

Code No.	Model No.	Power	Lumen	Efficacy	CCT	Current
611769	ILS12ATML930WW01	12W	920lm	77lm/W	3000k	53.6 mA
611770	ILS12ATML940NW01	12W	950lm	79lm/W	4000k	53.4 mA
611771	ILS12ATML930WW02	12W	920lm	77lm/W	3000k	54.6 mA
611772	ILS12ATML940NW02	12W	950lm	79lm/W	4000k	54 mA
611773	ILS20ATML930WW01	20W	1510lm	75lm/W	3000k	96.9 mA
611774	ILS20ATML940NW01	20W	1570lm	78lm/W	4000k	96.7 mA
611775	ILS20ATML930WW02	20W	1510lm	75lm/W	3000k	96.9 mA
611776	ILS20ATML940NW02	20W	1570lm	78lm/W	4000k	96.7 mA
611777	ILS31ATML930WW01	31W	2490lm	80lm/W	3000k	142.4 mA
611778	ILS31ATML940NW01	31W	2550lm	82lm/W	4000k	136.8 mA
611779	ILS31ATML930WW02	31W	2490lm	80lm/W	3000k	142.4 mA
611780	ILS31ATML940NW02	31W	2550lm	82lm/W	4000k	136.8 mA

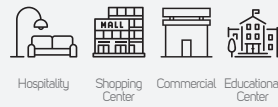

Poetic Moments

Technical Operating & Electrical Data

Input Voltage & Frequency	AC220-240V, 50/60Hz
IP Ratings	IP20
Body Material	Aluminum+Plastic
CRI	95
Beam Angle	24°
Type of Frame	Adjustable
Life Span	50000h

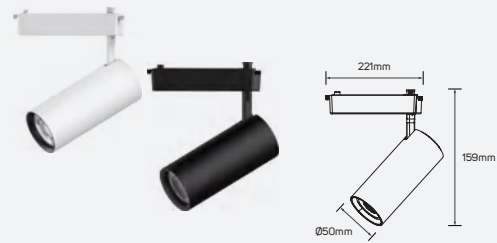

613195 - 613196 - 613197 - 613198

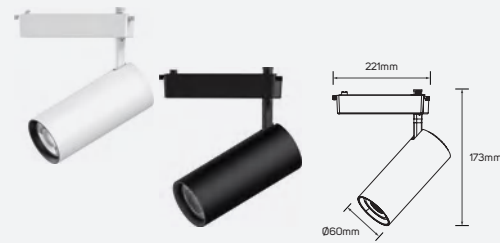

613199 - 613200 - 613201 - 613202

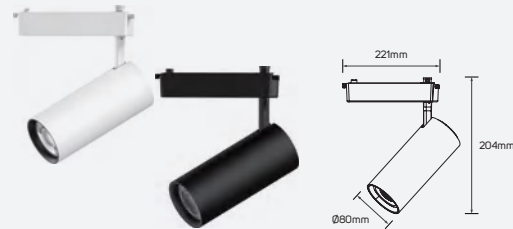

613203 - 613204 - 613205 - 613206

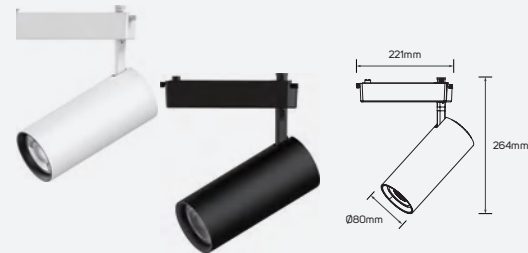

613207 - 613208 - 613209 - 613210

Family Product List

Code No.	Model No.	Power	Lumen	Efficacy	CCT	Body Color
▶ 613195	ILS11.5ATML930WW01	11.5W	950lm	82.61lm/W	3000k	matt white+black ring
▶ 613196	ILS11.5ATML940NW01	11.5W	1000lm	86.96lm/W	4000k	matt white+black ring
● 613197	ILS11.5ATML930WW02	11.5W	950lm	82.61lm/W	3000k	matt black
● 613198	ILS11.5ATML940NW02	11.5W	1000lm	86.96lm/W	4000k	matt black
▶ 613199	ILS19.5ATML930WW01	19.5W	1510lm	77.44lm/W	3000k	matt white+black ring
▶ 613200	ILS19.5ATML940NW01	19.5W	1600lm	82.05lm/W	4000k	matt white+black ring
● 613201	ILS19.5ATML930WW02	19.5W	1510lm	77.44lm/W	3000k	matt black
● 613202	ILS19.5ATML940NW02	19.5W	1600lm	82.05lm/W	4000k	matt black
▶ 613203	ILS30ATML930WW01	30W	2600lm	86.67lm/W	3000k	matt white+black ring
▶ 613204	ILS30ATML940NW01	30W	2800lm	93.33lm/W	4000k	matt white+black ring
● 613205	ILS30ATML930WW02	30W	2600lm	86.67lm/W	3000k	matt black
● 613206	ILS30ATML940NW02	30W	2800lm	93.33lm/W	4000k	matt black
▶ 613207	ILS40ATML930WW01	40W	3100lm	77.50lm/W	3000k	matt white+black ring
▶ 613208	ILS40ATML940NW01	40W	3300lm	82.50lm/W	4000k	matt white+black ring
● 613209	ILS40ATML930WW02	40W	3100lm	77.50lm/W	3000k	matt black
● 613210	ILS40ATML940NW02	40W	3300lm	82.50lm/W	4000k	matt black

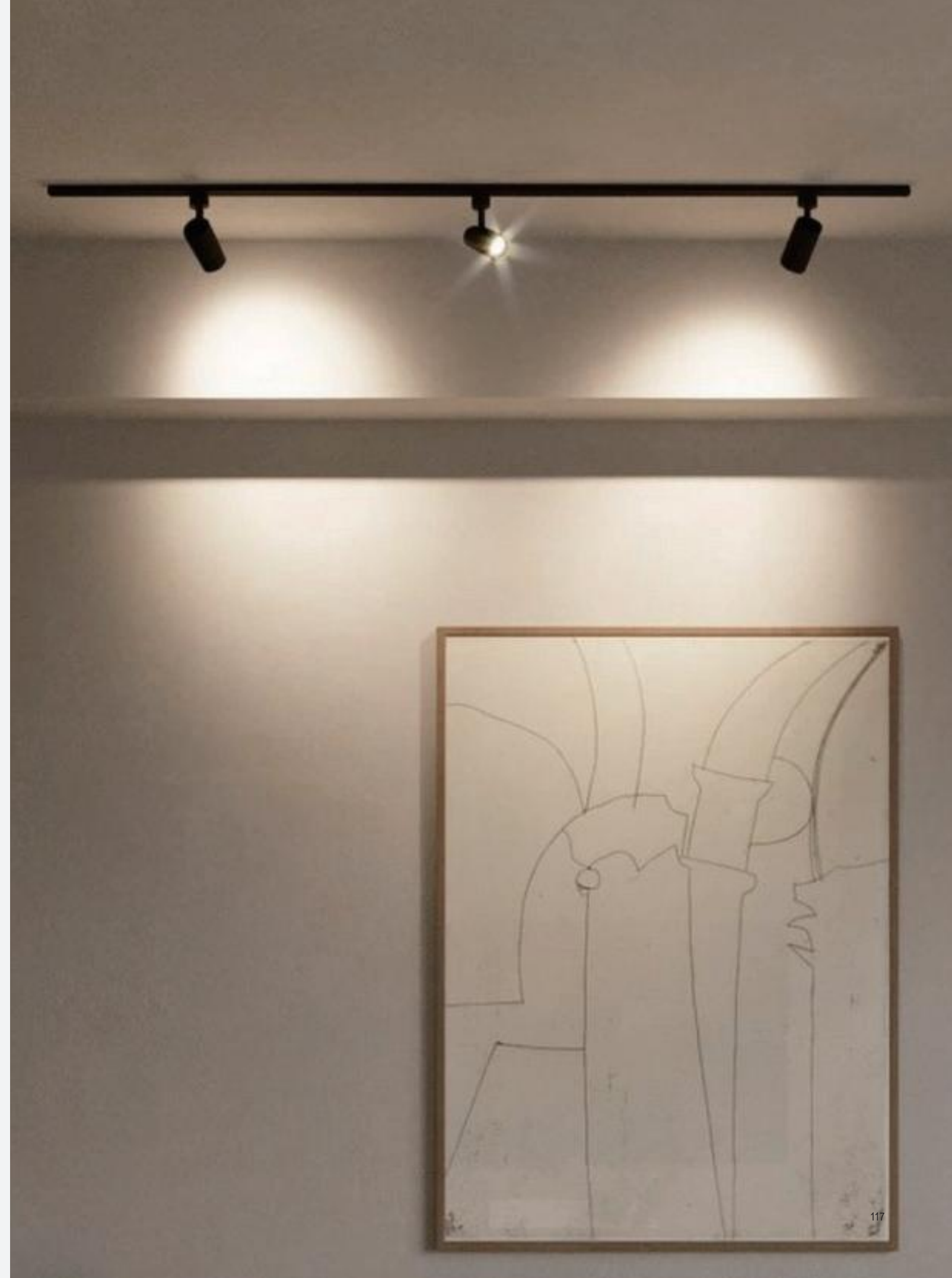



Track Mounted Luminaire - Pendant

Track Mounted Luminaire – Pendant

Sol

Technical Operating & Electrical Data

Input Voltage & Frequency	AC220-240V, 50/60Hz
IP Ratings	IP20
Body Material	Aluminum
Lamp Holder Type	GU10
Directional or Non Directional	Non Directional
Cable Dimensions	GU10 0.5mm2x80mm , cable 0.5mm2x2200mm

Areas of Application



612001 - 612002

612047 - 612048

612005 - 612006

612051 - 612052

Family Product List

Code No.	Model No.	Body Color	Mounting Type	Fixed or Adjustable
612001	ILSFTMPF01	white+black	track mounted luminaire (pendant)	fixed
612002	ILSFTMPF01	black	track mounted luminaire (pendant)	fixed
612005	ILSFTMPF02	white+black	track mounted luminaire (pendant)	adjustable
612006	ILSFTMPF02	black	track mounted luminaire (pendant)	adjustable
612047	ILSFTMPF03	white+black	surface-mounted on track	fixed
612048	ILSFTMPF03	black	surface-mounted on track	fixed
612051	ILSFTMPF04	white+black	surface-mounted on track	adjustable
612052	ILSFTMPF04	black	surface-mounted on track	adjustable



LED Recessed Linear Luminaire

Skyline

Technical Operating & Electrical Data

Input Voltage & Frequency	AC220-240V, 50/60Hz
IP Ratings	IP20
Body Material	Aluminum
CRI	80
Beam Angle	110°
Dimming	Non-Dimmable
Life Span	40000h

Areas of Application

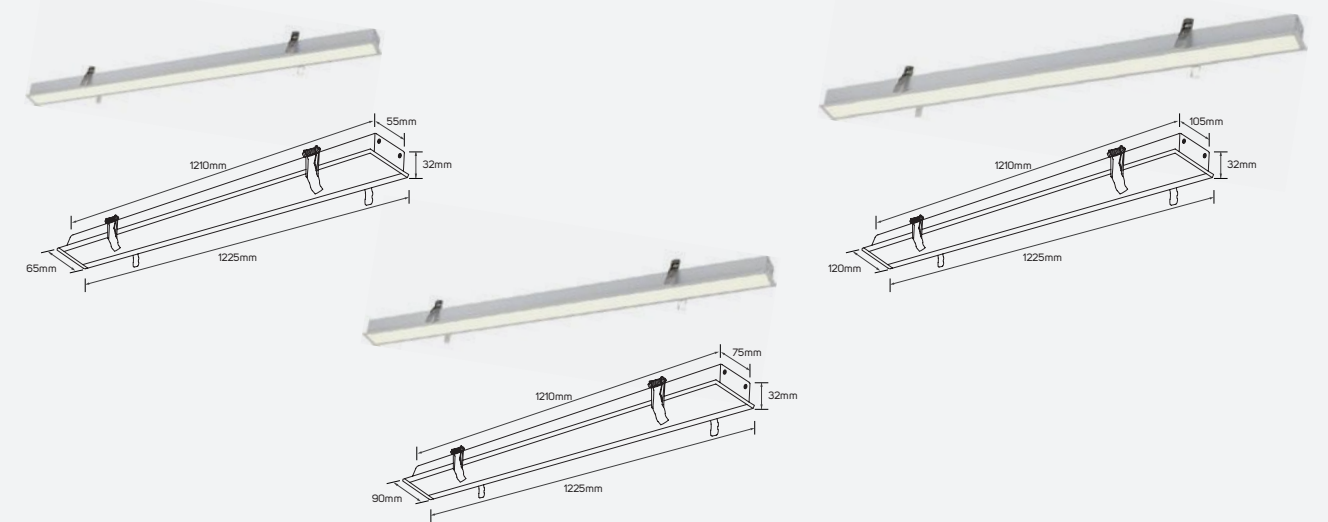
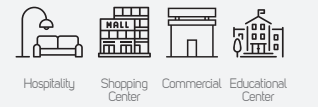

LED Recessed Linear Luminaire

PRODUCT INFORMATION

- Modern looking, neat luminaire offering comfortable, good quality lighting and can also work as a design element.
- Ideal lighting in the non-working areas of professional spaces such as offices, Educational institutes, and also the welcoming areas and entrances of retail spaces.
- ILLUS LED RECESSED LINEAR Luminaire gives the customer the flexibility to choose between 3 CCT based on their specific need with lumen package from 2060lm to 7200lm.

BENEFITS

- Uniform light.
- Multiple application use.
- Easy to install and maintain.

FEATURES

- High CRI>80.
- Efficacy up to 126lm/w.
- Long life span 40,000 hrs.
- Wide operating voltage AC20 – 240V.
- Non-Dimmable.

Family Product List

Code No.	Model No.	CCT	Power	Lumen	Efficacy	Cutting Size
611309	ILS40RLL830WW01	3000K	40W	4400lm	110lm/w	1210x75mm
611310	ILS40RLL857DL01	5700K	40W	4550lm	114lm/w	1210x75mm
611510	ILS40RLL840NW01	4000K	40W	4500lm	113lm/w	1210x75mm
611313	ILS20RLL830WW01	3000K	20W	2060lm	103lm/w	1210x55mm
611314	ILS20RLL857DL01	5700K	20W	2160lm	108lm/w	1210x55mm
611512	ILS20RLL840NW01	4000K	20W	2140lm	107lm/w	1210x55mm
612490	ILS57RLL830WW01	3000K	57W	6800lm	119lm/w	1210x105mm
612491	ILS57RLL857DL01	5700K	57W	7200lm	126lm/w	1210x105mm
612492	ILS57RLL840NW01	4000K	57W	7150lm	125lm/w	1210x105mm

Geostar

Technical Operating & Electrical Data

Input Voltage & Frequency	AC220-240V, 50/60Hz
IP Ratings	IP20
Body Material	Aluminum
Mounting Type	Recessed in Ceiling
Beam Angle	115°
Dimming	Non-Dimmable
Life Span	30000h

Areas of Application

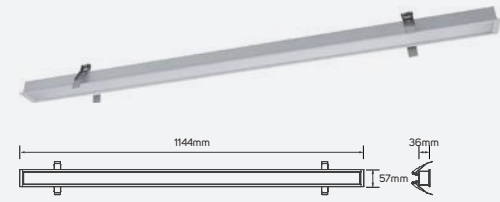
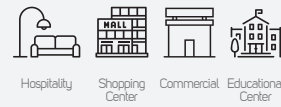

671059 - 671060 - 671061

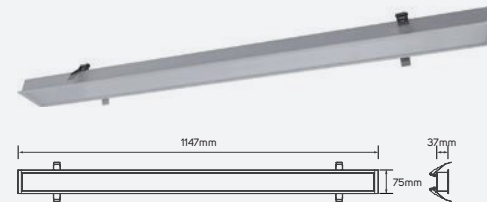

671062 - 671063 - 671064

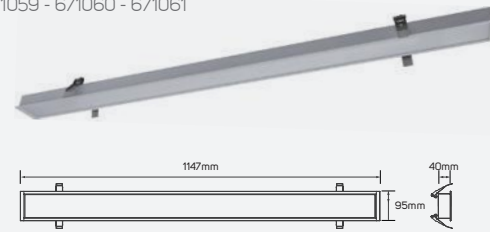

671065 - 671066 - 671067

Family Product List

Code No.	Model No.	CCT	Power	Lumen	Efficacy	Cutting Size
● 671059	ILS20RLL830WW02	3000K	20W	1700lm	85lm/w	1210x75mm
● 671060	ILS20RLL840NW02	4000K	20W	1800lm	90lm/w	1210x75mm
● 671061	ILS20RLL850DL02	5000K	20W	1850lm	92.5lm/w	1210x75mm
● 671062	ILS30RLL830WW01	3000K	30W	2500lm	83.33lm/w	1210x55mm
● 671063	ILS30RLL840NW01	4000K	30W	2700lm	90lm/w	1210x55mm
● 671064	ILS30RLL850DL01	5000K	30W	2750lm	91.67lm/w	1210x55mm
● 671065	ILS40RLL830WW02	3000K	40W	3300lm	82.5lm/w	1210x105mm
● 671066	ILS40RLL840NW02	4000K	40W	3500lm	87.5lm/w	1210x105mm
● 671067	ILS40RLL850DL02	5000K	40W	3600lm	90lm/w	1210x105mm

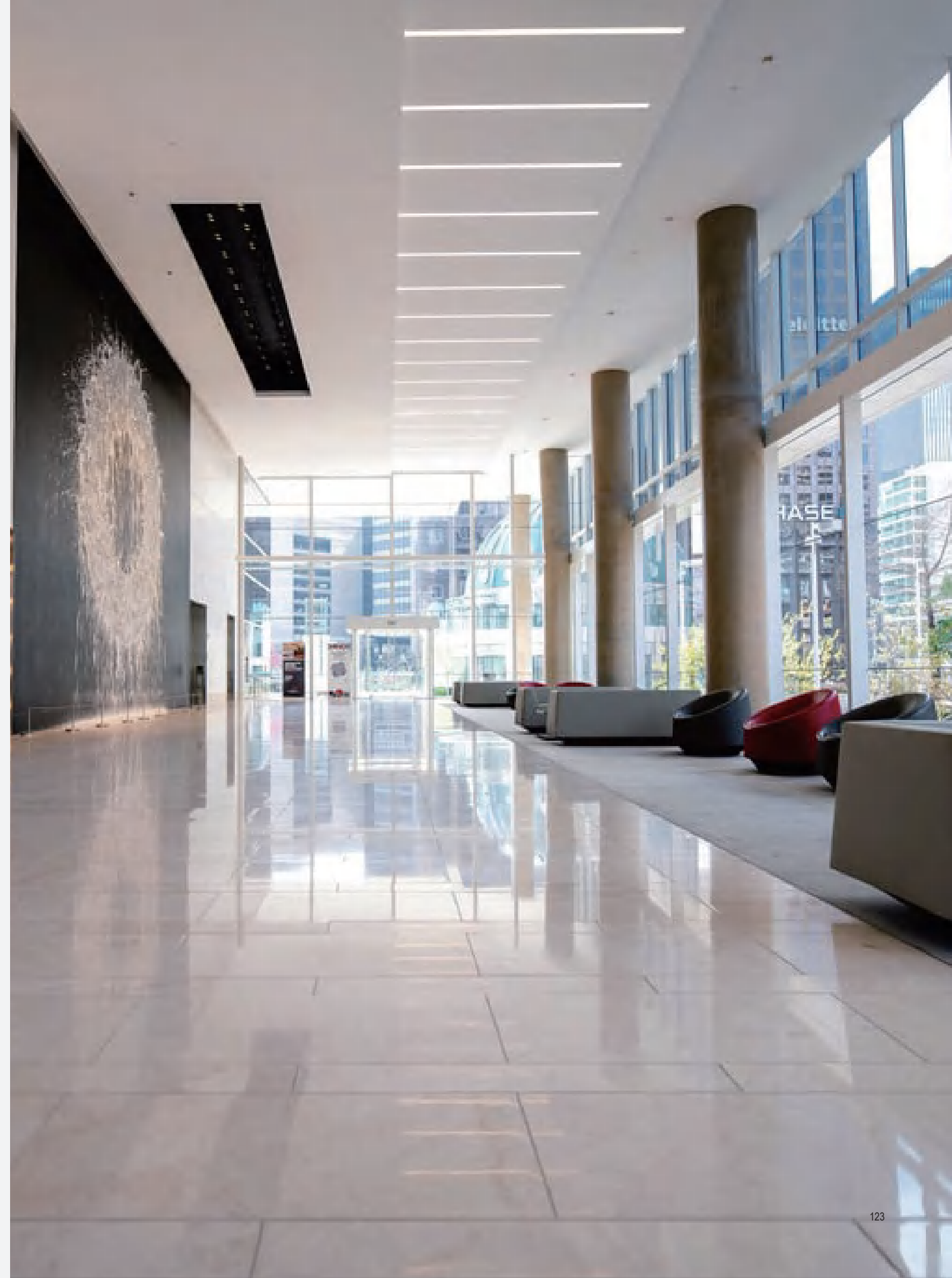



LED Recessed Linear Luminaire-Corner

LED Recessed Linear Luminaire (L-Shape)

Technical Operating & Electrical Data

Input Voltage & Frequency	AC220-240V, 50/60Hz
IP Ratings	IP20
Body Material	Aluminum
Body Color	Matt White
Mounting Type	Recessed in Ceiling
Dimming	Non-Dimmable
Life Span	30000h

Family Product List

Code No.	Power	CCT	Lumen	Efficacy
671068	10.5W	3000K	1070lm	101.9lm/w
671069	10.5W	4000K	1100lm	104.76lm/w
671070	10.5W	5000K	1150lm	109.52lm/w

■ Aluminum
 IP 20 ▽ 110°
 □ AC220-240V ⌚ 30,000h

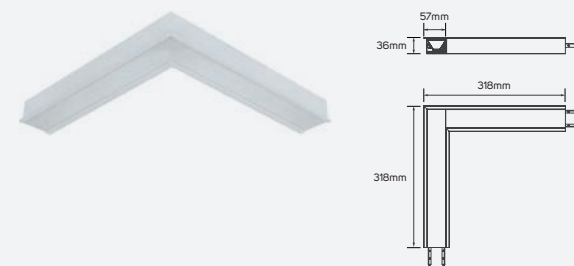

Diffuser

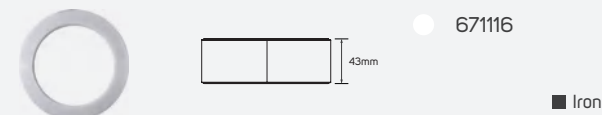

Connector

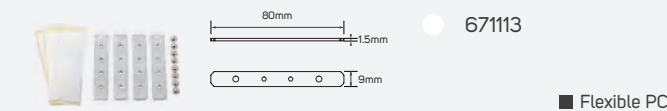

LED Recessed Linear Luminaire-Corner

PRODUCT INFORMATION

- Modern looking, neat luminaire offering comfortable, good quality lighting and can also work as a design element.
- Ideal lighting in the non-working areas of professional spaces such as offices, educational institutes, and also the welcoming areas and entrances of retail spaces.
- ILLUS LED RECESSED LINEAR Luminaire (CORNER) gives the customer the flexibility to choose between 9 models based on their specific need with lumen package from 1070 lm to 2300 lm.

BENEFITS

- Clean and uniform light.
- Multiple application use.
- Easy to install and maintain.

FEATURES

- High CRI>80.
- Efficacy up to 115lm/w.
- Life span 30,000 hrs.
- Operating voltage AC220 – 240V.
- Non – dimmable.

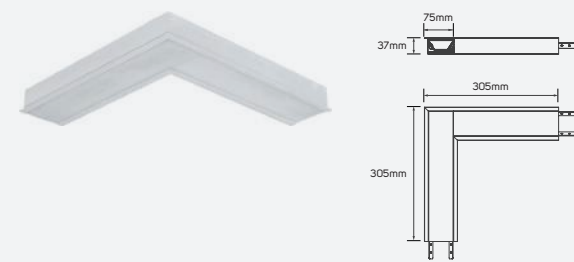

Diffuser

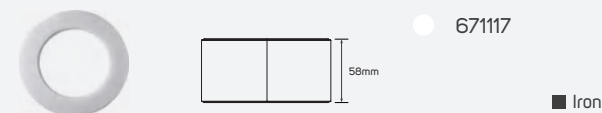

Family Product List

Code No.	Power	CCT	Lumen	Efficacy
671071	14W	3000K	1500lm	107.14lm/w
671072	14W	4000K	1570lm	112.14lm/w
671073	14W	5000K	1600lm	114.29lm/w

■ Aluminum
 IP 20 ▽ 115°
 □ AC220-240V ⌚ 30,000h

Connector

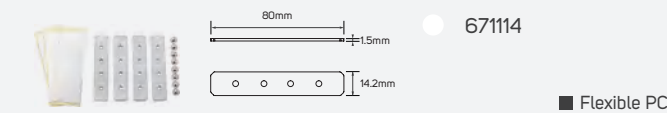

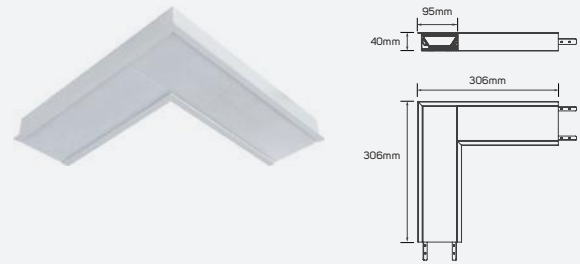

Diffuser

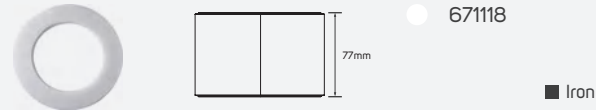

671118

■ Iron

Family Product List

Code No.	Power	CCT	Lumen	Efficacy
671074	20W	3000K	2100lm	105lm/w
671075	20W	4000K	2200lm	110lm/w
671076	20W	5000K	2300lm	115lm/w

■ Aluminum
 IP 20 ▽ 115°
 AC220-240V ⌚ 30,000h

Connector

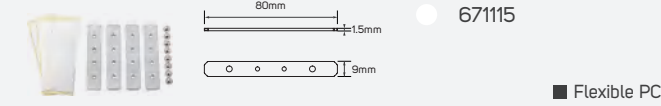

671115

■ Flexible PC

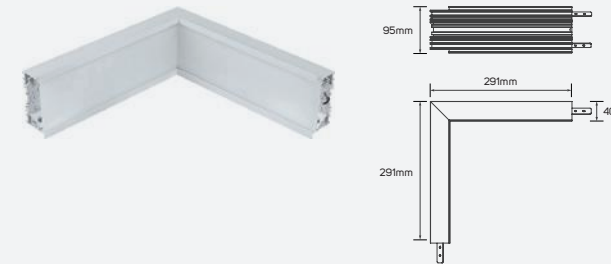

Diffuser

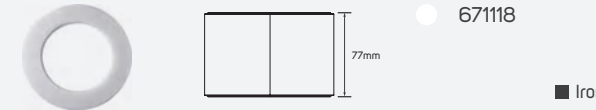

671118

■ Iron

Family Product List

Code No.	Power	CCT	Lumen	Efficacy
671083	20W	3000K	1980lm	99lm/w
671084	20W	4000K	2040lm	102lm/w
671085	20W	5000K	2100lm	105lm/w

■ Aluminum
 IP 20 ▽ 110°
 AC220-240V ⌚ 30,000h

Connector

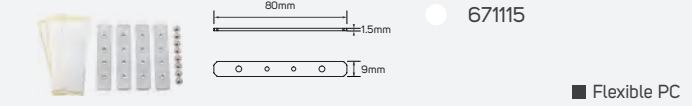

671115

■ Flexible PC

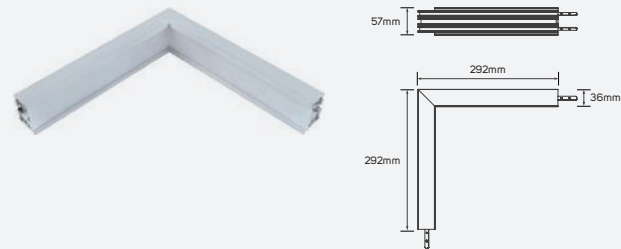

Diffuser

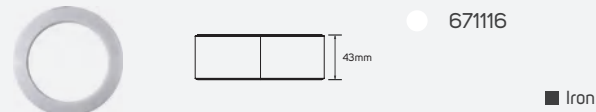

671116

■ Iron

Family Product List

Code No.	Power	CCT	Lumen	Efficacy
671077	10.5W	3000K	1000lm	95.24lm/w
671078	10.5W	4000K	1020lm	97.14lm/w
671079	10.5W	5000K	1040lm	99.05lm/w

■ Aluminum
 IP 20 ▽ 110°
 AC220-240V ⌚ 30,000h

Connector

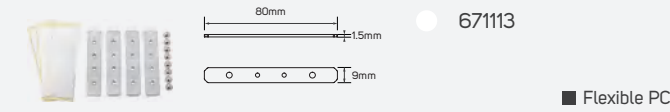

671113

■ Flexible PC



Diffuser

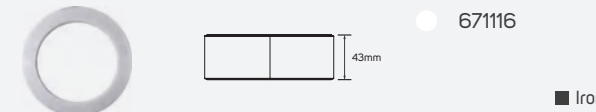

671116

■ Iron

Family Product List

Code No.	Power	CCT	Lumen	Efficacy
671086	11W	3000K	1060lm	96.36lm/w
671087	11W	4000K	1090lm	99.09lm/w
671088	11W	5000K	1110lm	100.91lm/w

■ Aluminum
 IP 20 ▽ 140°
 AC220-240V ⌚ 30,000h

Connector

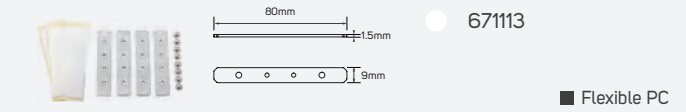

671113

■ Flexible PC



Diffuser

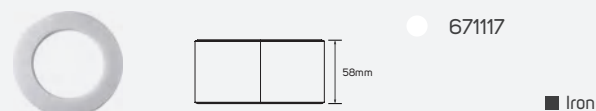

671117

■ Iron

Family Product List

Code No.	Power	CCT	Lumen	Efficacy
671080	14.5W	3000K	1350lm	93.1lm/w
671081	14.5W	4000K	1470lm	101.38lm/w
671082	14.5W	5000K	1500lm	103.45lm/w

■ Aluminum
 IP 20 ▽ 110°
 AC220-240V ⌚ 30,000h

Connector

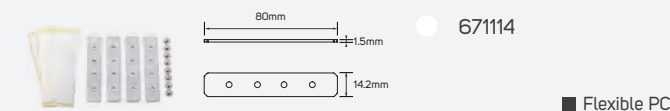

671114

■ Flexible PC



Diffuser

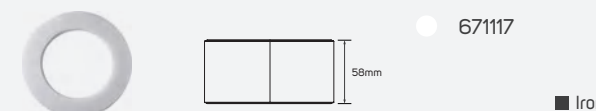

671117

■ Iron

Family Product List

Code No.	Power	CCT	Lumen	Efficacy
671089	14.5W	3000K	1570lm	108.28lm/w
671090	14.5W	4000K	1600lm	110.34lm/w
671091	14.5W	5000K	1650lm	113.79lm/w

■ Aluminum
 IP 20 ▽ 140°
 AC220-240V ⌚ 30,000h

Connector

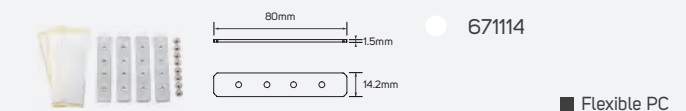

671114

■ Flexible PC

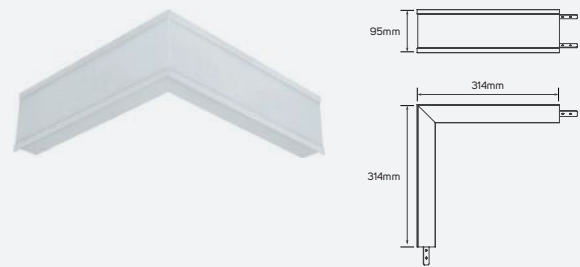

Diffuser

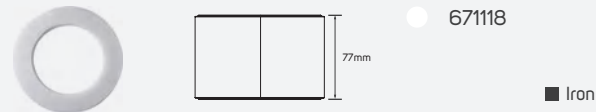

Family Product List

Code No.	Power	CCT	Lumen	Efficacy
----------	-------	-----	-------	----------

- 671092 20.5W 3000K 2100lm 102.44lm/w
- 671093 20.5W 4000K 2200lm 107.32lm/w
- 671094 20.5W 5000K 2250lm 109.76lm/w

- Aluminum
- IP 20
- AC220-240V
- 140°
- 30,000h

Connector

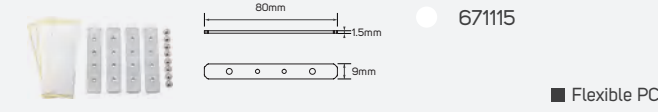

Family Product List

Code No.	Power	CCT	Lumen	Efficacy
----------	-------	-----	-------	----------

- 611511 8W 4000K 690lm 86.25lm/W
- 611311 8W 3000K 680lm 85.00lm/W
- 611312 8W 5700K 700lm 87.50lm/W
- 611513 4.5W 4000K 400lm 88.89lm/W
- 611315 4.5W 3000K 390lm 86.67lm/W
- 611316 4.5W 5700K 410lm 91.11lm/W

- Aluminum+PC
- IP 20
- AC220-240V
- 110°
- 50,000h

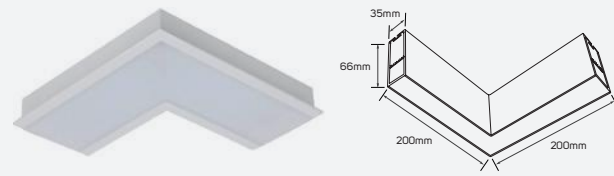

LED Recessed Linear Luminaire-Corner

LED Recessed Linear Luminaire (T-Shape)

Technical Operating & Electrical Data

- Input Voltage & Frequency: AC220-240V, 50/60Hz
- IP Ratings: IP20
- Body Material: Aluminum
- Body Color: Matt White
- Mounting Type: Recessed in Ceiling
- Dimming: Non-Dimmable
- Life Span: 30000h

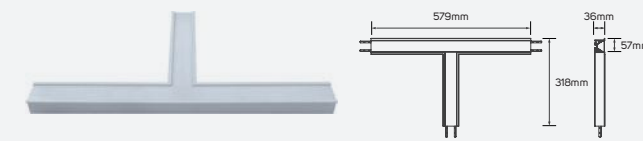

Diffuser

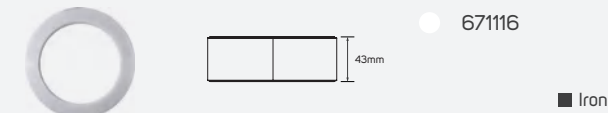

Family Product List

Code No.	Power	CCT	Lumen	Efficacy
----------	-------	-----	-------	----------

- 671095 14.5W 3000K 1570lm 108.28lm/w
- 671096 14.5W 4000K 1600lm 110.34lm/w
- 671097 14.5W 5000K 1650lm 113.79lm/w

- Aluminum
- IP 20
- AC220-240V
- 110°
- 30,000h

Connector

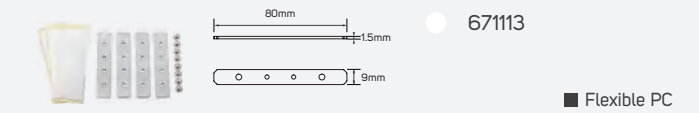

Family Product List

Code No.	Power	CCT	Lumen	Efficacy
----------	-------	-----	-------	----------

- 671098 21.5W 3000K 2250lm 104.65lm/w
- 671099 21.5W 4000K 2350lm 109.3lm/w
- 671100 21.5W 5000K 2450lm 113.95lm/w

- Aluminum
- IP 20
- AC220-240V
- 110°
- 30,000h

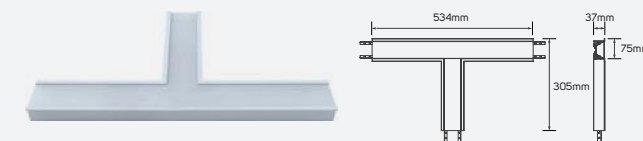

Diffuser

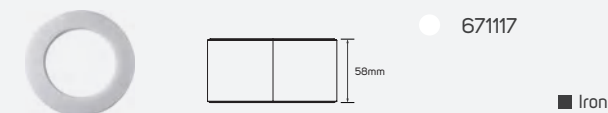

Connector

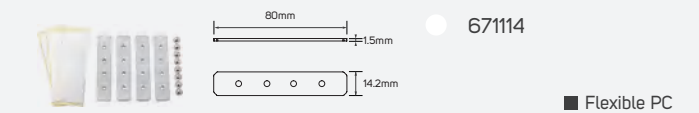

Family Product List

Code No.	Power	CCT	Lumen	Efficacy
----------	-------	-----	-------	----------

- 671101 30W 3000K 3150lm 105lm/w
- 671102 30W 4000K 3200lm 106.67lm/w
- 671103 30W 5000K 3250lm 108.33lm/w

■ Aluminum

IP 20

110°

AC220-240V

30,000h

Connector

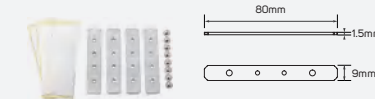

● 671115

■ Flexible PC

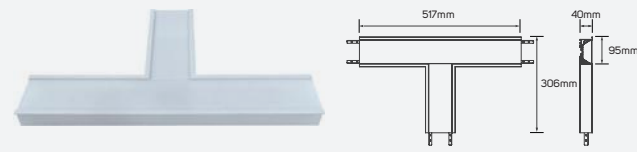

Diffuser

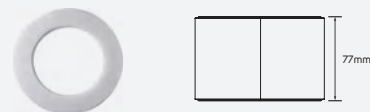

● 671118

■ Iron

LED Recessed Linear Luminaire-Corner

LED Recessed Linear Luminaire (X-Shape)

Technical Operating & Electrical Data

Input Voltage & Frequency	AC220-240V, 50/60Hz
IP Ratings	IP20
Body Material	Aluminum
Body Color	Matt White
Mounting Type	Recessed in Ceiling
Dimming	Non-Dimmable
Life Span	30000h

Family Product List

Code No.	Power	CCT	Lumen	Efficacy
----------	-------	-----	-------	----------

- 671104 20W 3000K 2110lm 105.5lm/w
- 671105 20W 4000K 2200lm 110lm/w
- 671106 20W 5000K 2280lm 114lm/w

■ Aluminum

IP 20

110°

AC220-240V

30,000h

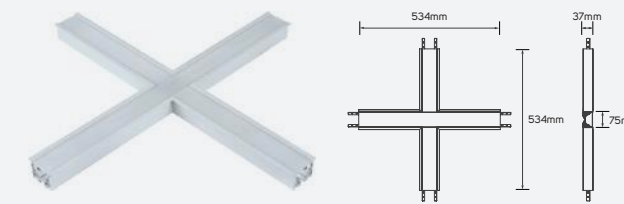

Diffuser



● 671116

■ Iron

Connector



● 671113

■ Flexible PC

Family Product List

Code No.	Power	CCT	Lumen	Efficacy
----------	-------	-----	-------	----------

- 671107 30W 3000K 3300lm 110lm/w
- 671108 30W 4000K 3400lm 113.33lm/w
- 671109 30W 5000K 3480lm 116lm/w

■ Aluminum

IP 20

110°

AC220-240V

30,000h

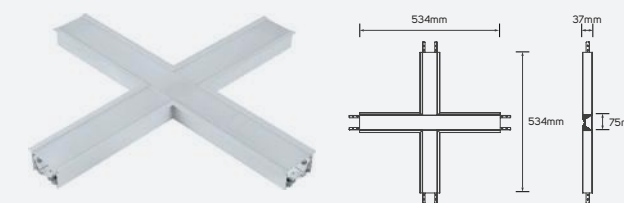

Diffuser

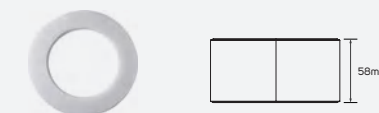

● 671117

■ Iron

Connector

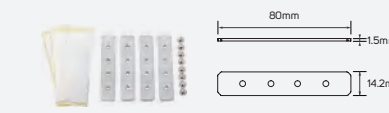

● 671114

■ Flexible PC

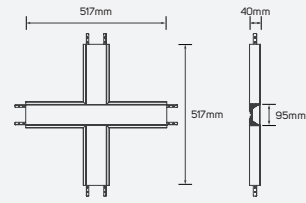

Family Product List

Code No.	Power	CCT	Lumen	Efficacy
● 671110	40W	3000K	4200lm	105lm/w
● 671111	40W	4000K	4500lm	112.5lm/w
● 671112	40W	5000K	4600lm	115lm/w

■ Aluminum
 IP 20 ▽ 110°
 AC220-240V ⌚ 30,000h

Diffuser

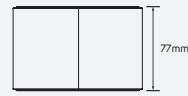

● 671118

■ Iron

Connector

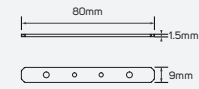

● 671115

■ Flexible PC





LED Pendant Linear Luminaire

Sebo

Technical Operating & Electrical Data

Input Voltage & Frequency	AC220-240V, 50/60Hz
IP Ratings	IP20
Body Material	Aluminum+Plastic
Beam Angle	48°
Mounting Type	Mounted on Ceiling
Dimming	Non-Dimmable
Life Span	30000h

Areas of Application

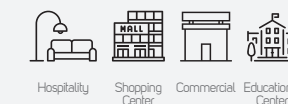

Dimensions

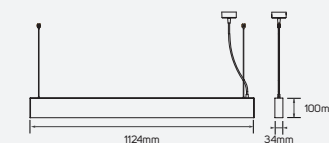

LED Pendant Linear Luminaire

PRODUCT INFORMATION

- Modern looking, neat luminaire offering comfortable, good quality lighting and can also work as a design element.
- Ideal lighting in the non-working areas of professional spaces such as offices, educational institutes, and also the welcoming areas and entrances of retail spaces.
- ILLUS LED PENDANT LINEAR Luminaire gives the customer the flexibility to choose between 12 models based on their specific need with lumen package from 2050 lm to 2650 lm.

BENEFITS

- Uniform light.
- Multiple application use.
- Easy to install and maintain.

FEATURES

- High CRI>90.
- Efficacy to 106lm/w.
- Long life span 30,000 hrs.
- Wide operating voltage AC220-240V.
- Non-dimmable.

Family Product List

Code No.	Model No.	Power	Lumen	Efficacy	CCT	Body Color
● 611583	ILS20DLLLLDB930WW01	20W	2050lm	103lm/w	3000K	black
● 611584	ILS20DLLLLDB940NW01	20W	2100lm	105lm/w	4000K	black
● 611585	ILS20DLLLLDB950DL01	20W	2120lm	106lm/w	5000K	black
● 611586	ILS20DLLLLDW930WW01	20W	2050lm	103lm/w	3000K	white
● 611587	ILS20DLLLLDW940NW01	20W	2100lm	105lm/w	4000K	white
● 611588	ILS20DLLLLDW950DL01	20W	2120lm	106lm/w	5000K	white
● 611589	ILS30DLLLLUB930WW01	30W	2450lm	81.67lm/w	3000K	black
● 611590	ILS30DLLLLUB940NW01	30W	2600lm	86.67lm/w	4000K	black
● 611591	ILS30DLLLLUB950DL01	30W	2650lm	88.33lm/w	5000K	black
● 611592	ILS30DLLLLUDW930WW01	30W	2450lm	81.67lm/w	3000K	white
● 611593	ILS30DLLLLUDW940NW01	30W	2600lm	86.67lm/w	4000K	white
● 611594	ILS30DLLLLUDW950DL01	30W	2650lm	88.33lm/w	5000K	white

Family Product List

Code No.	Model No.	Power	Lumen	Efficacy	CCT	Body Color
● 611595	ILS30DLLLLDB930WW01	30W	2850lm	95lm/w	3000K	black
● 611596	ILS30DLLLLDB940NW01	30W	3200lm	107lm/w	4000K	black
● 611597	ILS30DLLLLDB950DL01	30W	3250lm	108lm/w	5000K	black
● 611598	ILS30DLLLLDW930WW01	30W	2850lm	95lm/w	3000K	white
● 611599	ILS30DLLLLDW940NW01	30W	3200lm	107lm/w	4000K	white
● 611600	ILS30DLLLLDW950DL01	30W	3250lm	108lm/w	5000K	white
● 611601	ILS42DLLLLUB930WW01	42W	3480lm	83lm/w	3000K	black
● 611602	ILS42DLLLLUB940NW01	42W	3750lm	89lm/w	4000K	black
● 611603	ILS42DLLLLUB950DL01	42W	3800lm	90lm/w	5000K	black
● 611604	ILS42DLLLLUDW930WW01	42W	3480lm	83lm/w	3000K	white
● 611605	ILS42DLLLLUDW940NW01	42W	3750lm	89lm/w	4000K	white
● 611606	ILS42DLLLLUDW950DL01	42W	3800lm	90lm/w	5000K	white

LED Pendant Linear Luminaire

Lieus

Technical Operating & Electrical Data

Input Voltage & Frequency	AC220-240V, 50/60Hz
IP Ratings	IP20
Material	Aluminum+PC
Beam Angle	110°
CRI	80
Dimming	Non-Dimmable
Life Span	50000h



Areas of Application



Dimensions

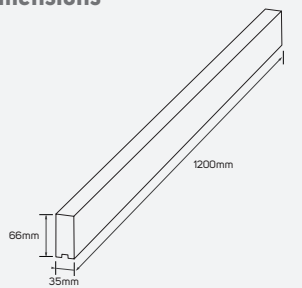

Family Product List

Code No.	Model No.	Power	Lumen	Efficacy	CCT	Body Color
● 611297	ILS20PLL830WW01	20W	1500lm	75lm/w	3000K	silver
● 611299	ILS20PLL830WW02	20W	1500lm	75lm/w	3000K	white
● 611301	ILS20PLL830WW03	20W	1500lm	75lm/w	3000K	black
● 611298	ILS20PLL857DL01	20W	1500lm	75lm/w	5700K	silver
● 611300	ILS20PLL857DL02	20W	1500lm	75lm/w	5700K	white
● 611302	ILS20PLL857DL03	20W	1500lm	75lm/w	5700K	black
● 611504	ILS20PLL840NW01	20W	1500lm	75lm/w	4000K	silver
● 611505	ILS20PLL840NW02	20W	1500lm	75lm/w	4000K	white
● 611506	ILS20PLL840NW03	20W	1500lm	75lm/w	4000K	black

LED Pendant Linear Luminaire

Tataro

Technical Operating & Electrical Data

Input Voltage & Frequency	AC220-240V, 50/60Hz
IP Ratings	IP20
Material	Aluminum+PC
Beam Angle	110°
CRI	80
Dimming	Non-Dimmable
Life Span	50000h



Areas of Application

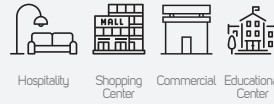

Dimensions

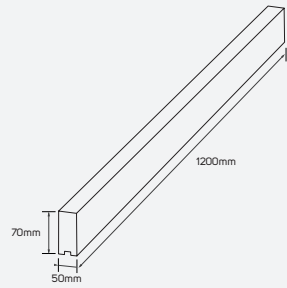

Family Product List

Code No.	Model No.	Power	Lumen	Efficacy	CCT	Body Color
● 611285	ILS40PLL830WW04	40W	3500lm	88lm/w	3000K	silver
● 611286	ILS40PLL857DL04	40W	3500lm	88lm/w	5700K	silver
● 611287	ILS40PLL830WW05	40W	3500lm	88lm/w	3000K	white
● 611288	ILS40PLL857DL05	40W	3500lm	88lm/w	5700K	white
● 611289	ILS40PLL830WW06	40W	3500lm	88lm/w	3000K	black
● 611290	ILS40PLL857DL06	40W	3500lm	88lm/w	5700K	black
● 611498	ILS40PLL840NW04	40W	3500lm	88lm/w	4000K	silver
● 611499	ILS40PLL840NW05	40W	3500lm	88lm/w	4000K	white
● 611500	ILS40PLL840NW06	40W	3500lm	88lm/w	4000K	black

LED Pendant Linear Luminaire

Tido

Technical Operating & Electrical Data

Input Voltage & Frequency	AC220-240V, 50/60Hz
IP Ratings	IP20
Material	Aluminum
Beam Angle	115°
CRI	80
Dimming	Non-Dimmable
Fixed or Adjustable	Adjustable
Life Span	30000h



Areas of Application

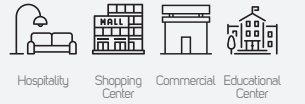

Dimensions

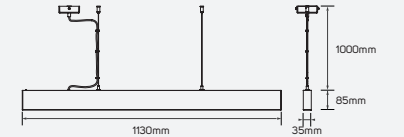

Family Product List

Code No.	Model No.	Power	Lumen	Efficacy	CCT	Body Color
● 671119	ILS14.5PLL830WW01	14.5W	1070lm	73.79lm/w	3000K	aluminum
● 671120	ILS14.5PLL840NW01	14.5W	1150lm	79.31lm/w	4000K	aluminum
● 671121	ILS14.5PLL850DL01	14.5W	1200lm	82.76lm/w	5000K	aluminum
● 671122	ILS14.5PLL830WW02	14.5W	1150lm	79.31lm/w	3000K	mat white
● 671123	ILS14.5PLL840NW02	14.5W	1250lm	86.21lm/w	4000K	mat white
● 671124	ILS14.5PLL850DL02	14.5W	1300lm	89.66lm/w	5000K	mat white
● 671125	ILS14.5PLL830WW03	14.5W	950lm	65.52lm/w	3000K	mat black
● 671126	ILS14.5PLL840NW03	14.5W	1050lm	72.41lm/w	4000K	mat black
● 671127	ILS14.5PLL850DL03	14.5W	1100lm	75.86lm/w	5000K	mat black

LED Pendant Linear Luminaire

Xenon

Technical Operating & Electrical Data

Input Voltage & Frequency	AC220-240V, 50/60Hz
IP Ratings	IP20
Material	Aluminum
Beam Angle	115°
CRI	80
Dimming	Non-Dimmable
Fixed or Adjustable	Adjustable
Life Span	30000h



Areas of Application

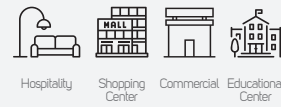

Dimensions

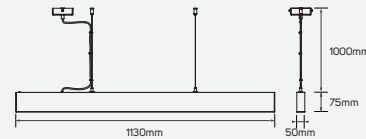

Family Product List

Code No.	Model No.	Power	Lumen	Efficacy	CCT	Body Color
● 671128	ILS30PLL830WW01	30W	2400lm	80lm/w	3000K	Silver
● 671129	ILS30PLL840NW01	30W	2550lm	85lm/w	4000K	Silver
● 671130	ILS30PLL850DL01	30W	2650lm	88.33lm/w	5000K	Silver
● 671131	ILS30PLL830WW02	30W	2550lm	85lm/w	3000K	matt white
● 671132	ILS30PLL840NW02	30W	2700lm	90lm/w	4000K	matt white
● 671133	ILS30PLL850DL02	30W	2800lm	93.33lm/w	5000K	matt white
● 671134	ILS30PLL830WW03	30W	2300lm	76.67lm/w	3000K	matt black
● 671135	ILS30PLL840NW03	30W	2550lm	85lm/w	4000K	matt black
● 671136	ILS30PLL850DL03	30W	2600lm	86.67lm/w	5000K	matt black

LED Pendant Linear Luminaire

Leyus

Technical Operating & Electrical Data

Input Voltage & Frequency	AC220-240V, 50/60Hz
IP Ratings	IP20
Material	Aluminum
Beam Angle	110°
Mounting Type	Mounted on Ceiling
Dimming	Non-Dimmable
Fixed or Adjustable	Fixed
Life Span	50000h



Areas of Application



Dimensions

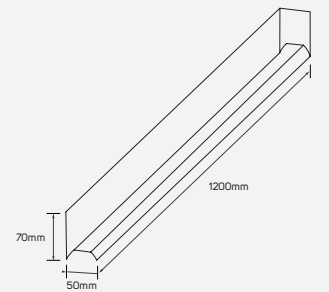

Family Product List

Code No.	Model No.	Power	Lumen	Efficacy	CCT	Body Color
● 611279	ILS40PLL830WW01	40W	3304lm	83lm/W	3000K	silver
● 611280	ILS40PLL857DL01	40W	3650lm	91lm/W	5700K	silver
● 611495	ILS40PLL840NW01	40W	3470lm	87lm/W	4000K	silver
● 611281	ILS40PLL830WW02	40W	3304lm	83lm/W	3000K	white
● 611282	ILS40PLL857DL02	40W	3650lm	91lm/W	5700K	white
● 611496	ILS40PLL840NW02	40W	3470lm	87lm/W	4000K	white
● 611283	ILS40PLL830WW03	40W	3300lm	83lm/W	3000K	black
● 611284	ILS40PLL857DL03	40W	3650lm	91lm/W	5700K	black
● 611497	ILS40PLL840NW03	40W	3470lm	87lm/W	4000K	black

Starry Romance

Areas of Application

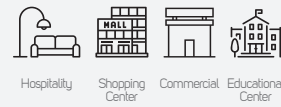

Technical Operating & Electrical Data

Input Voltage & Frequency	AC220-240V, 50/60Hz
IP Ratings	IP20
Material	Aluminum
Beam Angle	36°
Rated CRI	95
Dimming	Dimmable
Life Span	30000h



Dimensions

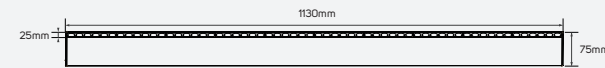

Family Product List

Code No.	Model No.	Power	Lumen	Efficacy	CCT	Body Color
● 614228	ILS20DPLL930WWMB01	20W	2000lm	100lm/W	3000K	Matt black
● 614229	ILS20DPLL940NWMB01	20W	2250lm	112.5lm/W	4000K	Matt black
● 614230	ILS20DPLL930WWMW01	20W	2000lm	100lm/W	3000K	Matt white
● 614231	ILS20DPLL940NWMW01	20W	2250lm	112.5lm/W	4000K	Matt white
● 614232	ILS30DPLL930WWMB01	30W	2850lm	95lm/W	3000K	Matt black
● 614233	ILS30DPLL940NWMB01	30W	3150lm	105lm/W	4000K	Matt black
● 614234	ILS30DPLL930WWMW01	30W	2850lm	95lm/W	3000K	Matt white
● 614235	ILS30DPLL940NWMW01	30W	3150lm	105lm/W	4000K	Matt white





LED Pendant Linear Luminaire-Corner

LED Pendant Linear Luminaire (L-Shape)

Technical Operating & Electrical Data

Input Voltage & Frequency	AC220-240V, 50/60Hz
IP Ratings	IP20
Body Material	Aluminum
Beam Angle	110°
Fixed or Adjustable	Adjustable
Dimming	Non-Dimmable
Life Span	30000h

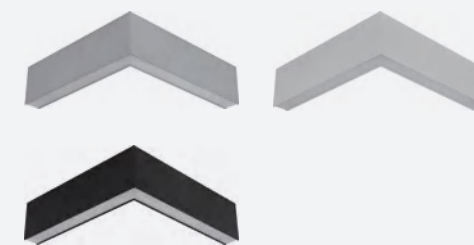

Dimensions

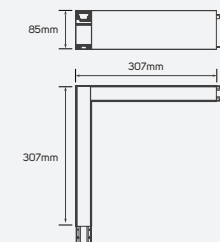

Diffuser



671193

Iron

Connector



671191

Flexible PC

Connector

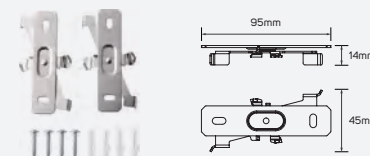

671195

Flexible PC

Connector

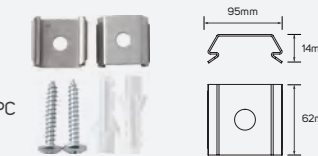

671197

Stainless Steel

Connector

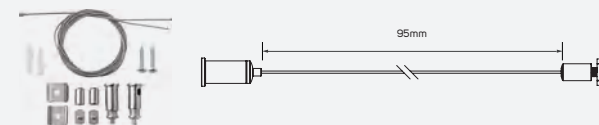

671198

Stainless Steel+Iron

LED Pendant Linear Luminaire-Corner

PRODUCT INFORMATION

- Modern looking, neat luminaire offering comfortable, good quality lighting and can also work as a design element.
- Ideal lighting in the non-working areas of professional spaces such as offices, educational institutes, and also the welcoming areas and entrances of retail spaces.
- ILLUS LED PENDANT LINEAR Luminaire gives the customer the flexibility to choose between 9 models based on their specific need with lumen package from 630 lm to 790 lm.

BENEFITS

- Uniform light.
- Multiple application use.
- Easy to install and maintain.

FEATURES

- High CRI>90.
- Efficacy to 105lm/w.
- Long life span 30,000 hrs.
- Wide operating voltage AC220-240V.
- Non-dimmable.

Family Product List

Code No.	Model No.	Power	Lumen	Efficacy	CCT	Body Color
671137	ILS7.5PLLL830WW01	7.5W	700lm	93.33lm/w	3000K	aluminum
671138	ILS7.5PLLL840NW01	7.5W	730lm	97.33lm/w	4000K	aluminum
671139	ILS7.5PLLL850DL01	7.5W	740lm	98.67lm/w	5000K	aluminum
671140	ILS7.5PLLL830WW02	7.5W	750lm	100lm/w	3000K	matt white
671141	ILS7.5PLLL840NW02	7.5W	780lm	104lm/w	4000K	matt white
671142	ILS7.5PLLL850DL02	7.5W	790lm	105.33lm/w	5000K	matt white
671143	ILS7.5PLLL830WW03	7.5W	630lm	84lm/w	3000K	matt black
671144	ILS7.5PLLL840NW03	7.5W	660lm	88lm/w	4000K	matt black
671145	ILS7.5PLLL850DL03	7.5W	670lm	89.33lm/w	5000K	matt black

LED Pendant Linear Luminaire (L-Shape)

Technical Operating & Electrical Data

Input Voltage & Frequency	AC220-240V, 50/60Hz
IP Ratings	IP20
Body Material	Aluminum
Beam Angle	110°
Fixed or Adjustable	Adjustable
Dimming	Non-Dimmable
Life Span	30000h

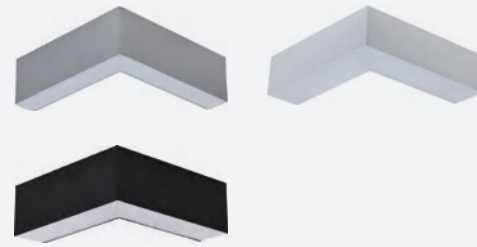

Dimensions

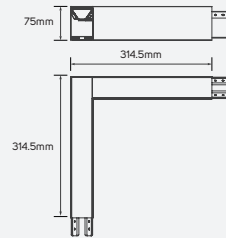

Diffuser

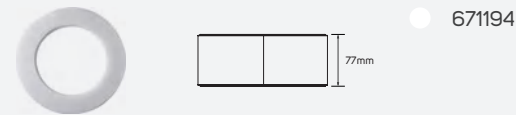

671194

Iron

Connector

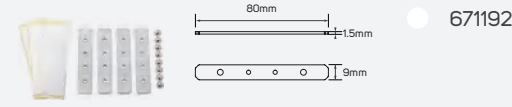

671192

Flexible PC

Connector

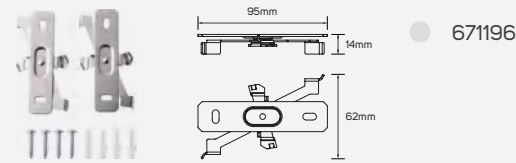

671196

Flexible PC

Connector

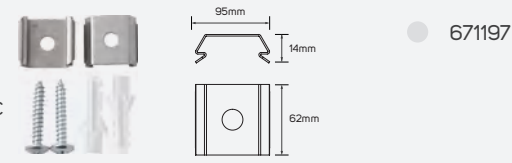

671197

Stainless Steel

Connector

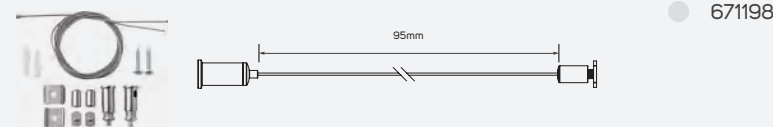

671198

Stainless Steel+Iron

Family Product List

Code No.	Model No.	Power	Lumen	Efficacy	CCT	Body Color
671146	ILS14PLLL830WW01	14W	1500lm	107.14lm/w	3000K	aluminum
671147	ILS14PLLL840NW01	14W	1600lm	114.29lm/w	4000K	aluminum
671148	ILS14PLLL850DL01	14W	1650lm	117.86lm/w	5000K	aluminum
671149	ILS14PLLL830WW02	14W	1540lm	110lm/w	3000K	matt white
671150	ILS14PLLL840NW02	14W	1620lm	115.71lm/w	4000K	matt white
671151	ILS14PLLL850DL02	14W	1650lm	117.86lm/w	5000K	matt white
671152	ILS14PLLL830WW03	14W	1420lm	101.43lm/w	3000K	matt black
671153	ILS14PLLL840NW03	14W	1500lm	107.14lm/w	4000K	matt black
671154	ILS14PLLL850DL03	14W	1550lm	110.71lm/w	5000K	matt black

LED Pendant Linear Luminaire (L-Shape)

Technical Operating & Electrical Data

Input Voltage & Frequency	AC220-240V, 50/60Hz
IP Ratings	IP20
Body Material	Aluminum
Beam Angle	112°
Fixed or Adjustable	Fixed
Dimming	Non-Dimmable
Life Span	50000h

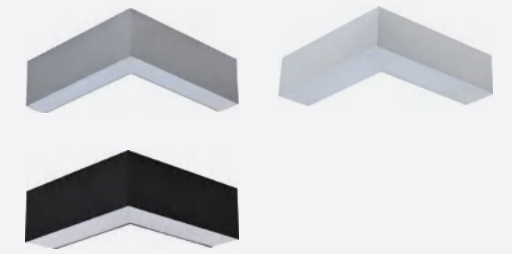

Dimensions

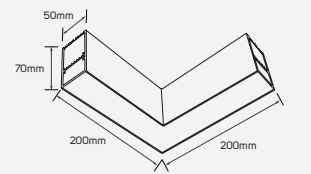

Diffuser

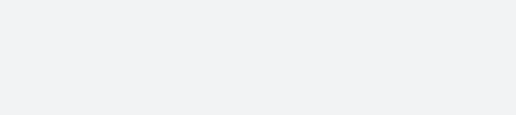

671194

Iron

Connector

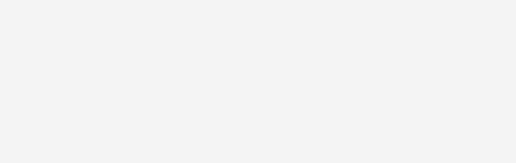

671192

Flexible PC

Connector

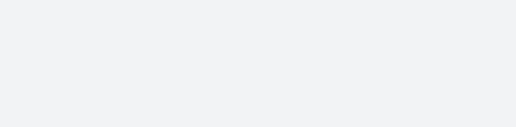

671196

Flexible PC

Family Product List

Code No.	Model No.	Power	Lumen	Efficacy	CCT	Body Color
611501	ILS9.6PLL840NW01	9.6W	880lm	92lm/W	4000K	silver
611502	ILS9.6PLL840NW02	9.6W	880lm	92lm/W	4000K	white
611503	ILS9.6PLL840NW03	9.6W	880lm	92lm/W	4000K	black
611291	ILS9.6PLLC830WW01	9.6W	850lm	89lm/W	3000K	silver
611292	ILS9.6PLLC857DL01	9.6W	910lm	95lm/W	5700K	silver
611293	ILS9.6PLLC830WW02	9.6W	850lm	89lm/W	3000K	white
611294	ILS9.6PLLC857DL02	9.6W	910lm	95lm/W	5700K	white
611295	ILS9.6PLLC830WW03	9.6W	850lm	89lm/W	3000K	black
611296	ILS9.6PLLC857DL03	9.6W	910lm	95lm/W	5700K	black

LED Pendant Linear Luminaire (L-Shape)

Technical Operating & Electrical Data

Input Voltage & Frequency	AC220-240V, 50/60Hz
IP Ratings	IP20
Body Material	Aluminum+PC
Beam Angle	112°
Fixed or Adjustable	Fixed
Dimming	Non-Dimmable
Life Span	50000h

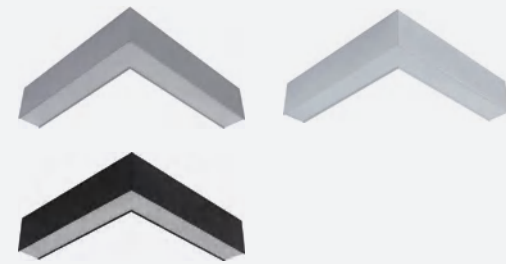

Dimensions

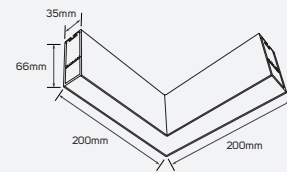

Family Product List

Code No.	Model No.	Power	Lumen	Efficacy	CCT	Body Color
● 611507	ILS5.4PLL840NW01	7W	600lm	86lm/W	3000K	silver
● 611508	ILS5.4PLLC840NW02	7.3W	640lm	88lm/W	4000K	white
● 611509	ILS5.4PLLC840NW03	7.3W	620lm	85lm/W	4000K	black
● 611303	ILS5.4PLL830WW01	7W	580lm	83lm/W	3000K	white
● 611304	ILS5.4PLL857DL01	7W	580lm	83lm/W	5700K	white
● 611305	ILS5.4PLLC830WW02	7.3W	600lm	82lm/W	3000K	white
● 611306	ILS5.4PLLC857DL02	5.4W	640lm	119lm/W	5700K	white
● 611307	ILS5.4PLLC830WW03	7.3W	640lm	82lm/W	3000K	black
● 611308	ILS5.4PLLC857DL03	7.3W	640lm	88lm/W	5700K	black

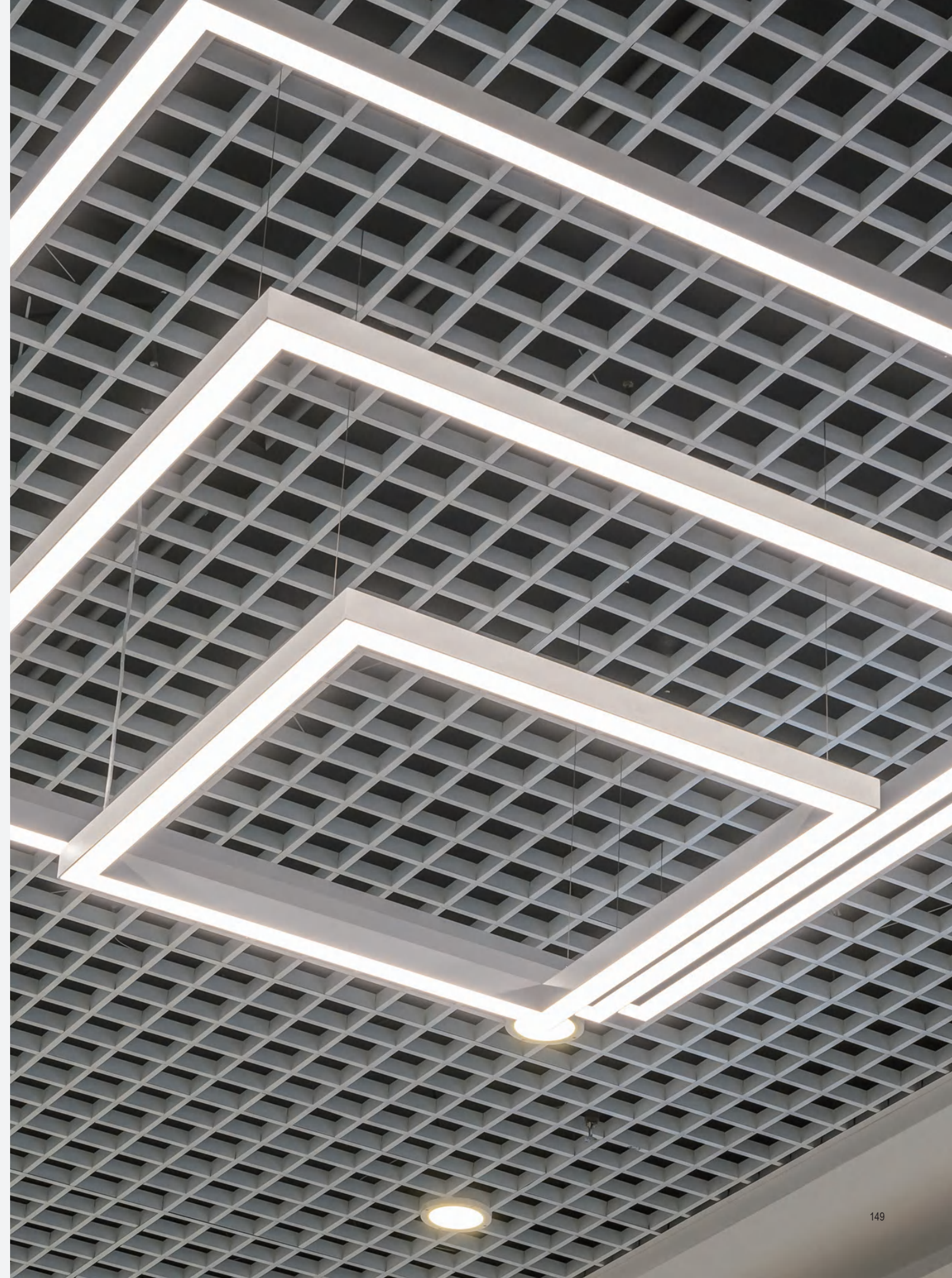

LED Pendant Linear Luminaire (T-Shape)

Technical Operating & Electrical Data

Input Voltage & Frequency	AC220-240V, 50/60Hz
IP Ratings	IP20
Body Material	Aluminum
Beam Angle	110°
Fixed or Adjustable	Adjustable
Dimming	Non-Dimmable
Life Span	30000h

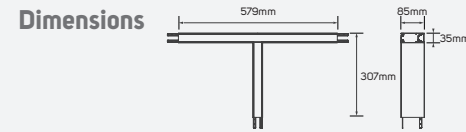

Diffuser

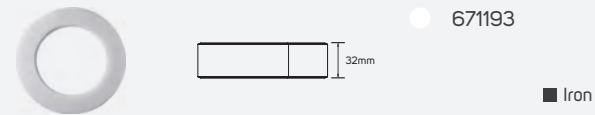

Connector

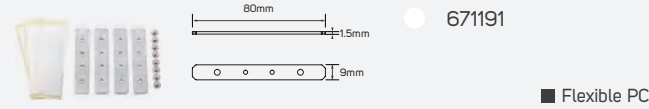

Connector

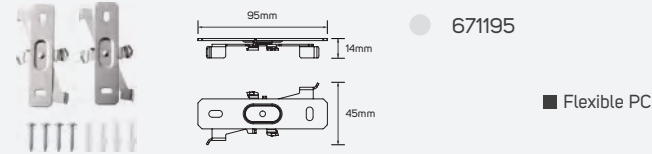

Connector

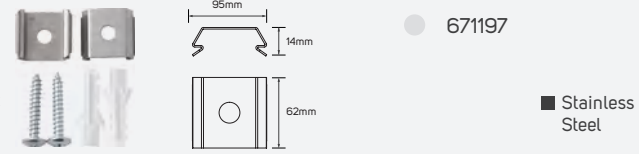

Connector

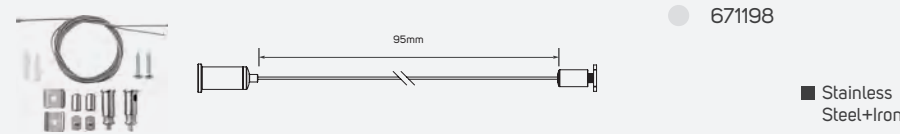

Family Product List

Code No.	Model No.	Power	Lumen	Efficacy	CCT	Body Color
● 671155	ILS10.5PLLT830WW01	10.5W	1000lm	95.24lm/w	3000K	aluminum
● 671156	ILS10.5PLLT840NW01	10.5W	1060lm	100.95lm/w	4000K	aluminum
● 671157	ILS10.5PLLT850DL01	10.5W	1100lm	104.76lm/w	5000K	aluminum
● 671158	ILS10.5PLLT830WW02	10.5W	1040lm	99.05lm/w	3000K	matt white
● 671159	ILS10.5PLLT840NW02	10.5W	1100lm	104.76lm/w	4000K	matt white
● 671160	ILS10.5PLLT850DL02	10.5W	1140lm	108.57lm/w	5000K	matt white
● 671161	ILS10.5PLLT830WW03	10.5W	900lm	85.71lm/w	3000K	matt black
● 671162	ILS10.5PLLT840NW03	10.5W	960lm	91.43lm/w	4000K	matt black
● 671163	ILS10.5PLLT850DL03	10.5W	1000lm	95.24lm/w	5000K	matt black

LED Pendant Linear Luminaire (T-Shape)

Technical Operating & Electrical Data

Input Voltage & Frequency	AC220-240V, 50/60Hz
IP Ratings	IP20
Body Material	Aluminum
Beam Angle	110°
Fixed or Adjustable	Adjustable
Dimming	Non-Dimmable
Life Span	30000h

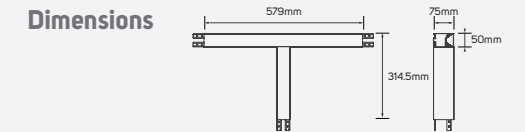
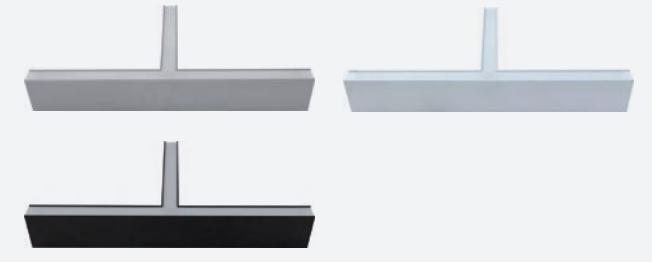

Diffuser

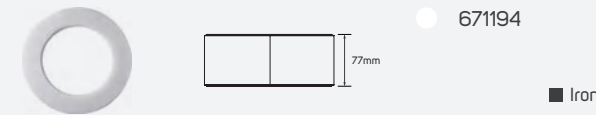

Connector

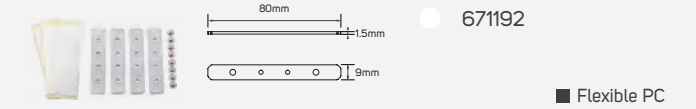

Connector

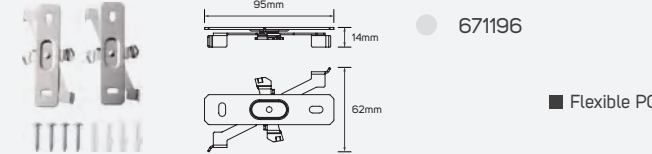

Connector

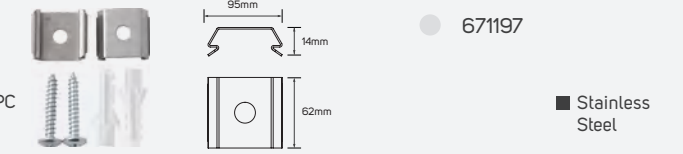

Connector

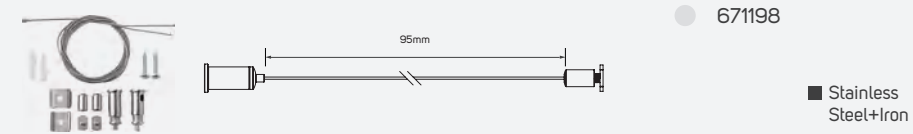

Family Product List

Code No.	Model No.	Power	Lumen	Efficacy	CCT	Body Color
● 671164	ILS21.5PLLT830WW01	21.5W	2100lm	97.67lm/w	3000K	aluminum
● 671165	ILS21.5PLLT840NW01	21.5W	2250lm	104.65lm/w	4000K	aluminum
● 671166	ILS21.5PLLT850DL01	21.5W	2350lm	109.3lm/w	5000K	aluminum
● 671167	ILS21.5PLLT830WW02	21.5W	2250lm	104.65lm/w	3000K	matt white
● 671168	ILS21.5PLLT840NW02	21.5W	2450lm	113.95lm/w	4000K	matt white
● 671169	ILS21.5PLLT850DL02	21.5W	2540lm	118.14lm/w	5000K	matt white
● 671170	ILS21.5PLLT830WW03	21.5W	2050lm	95.35lm/w	3000K	matt black
● 671171	ILS21.5PLLT840NW03	21.5W	2250lm	104.65lm/w	4000K	matt black
● 671172	ILS21.5PLLT850DL03	21.5W	2350lm	109.3lm/w	5000K	matt black

LED Pendant Linear Luminaire (X-Shape)

Technical Operating & Electrical Data

Input Voltage & Frequency	AC220-240V, 50/60Hz
IP Ratings	IP20
Body Material	Aluminum
Beam Angle	110°
Fixed or Adjustable	Adjustable
Dimming	Non-Dimmable
Life Span	30000h

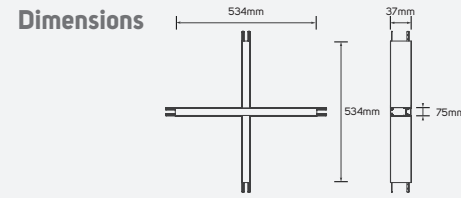
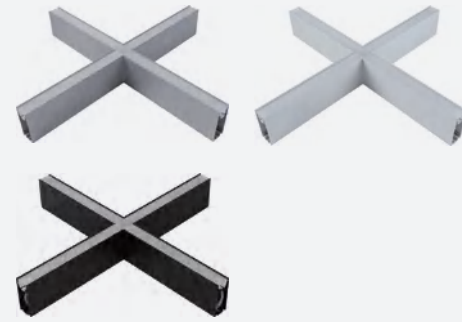

Diffuser

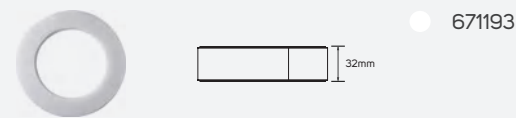

671193

■ Iron

Connector

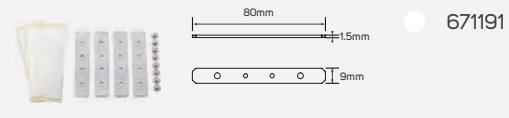

671191

■ Flexible PC

Connector

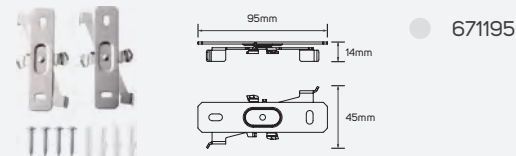

671195

■ Flexible PC

Connector

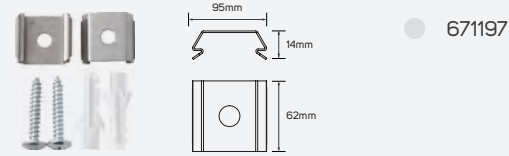

671197

■ Stainless Steel

Connector

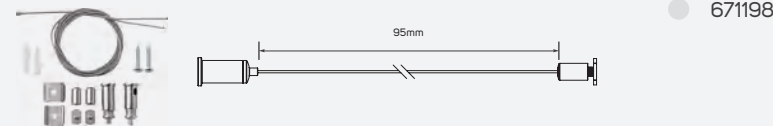

671198

■ Stainless Steel+Iron

Family Product List

Code No.	Model No.	Power	Lumen	Efficacy	CCT	Body Color
● 671173	ILS14PLLX830WW01	14W	1400lm	100lm/w	3000K	Silver
● 671174	ILS14PLLX840NW01	14W	1500lm	107.14lm/w	4000K	Silver
● 671175	ILS14PLLX850DL01	14W	1550lm	110.71lm/w	5000K	Silver
● 671176	ILS14PLLX830WW02	14W	1500lm	107.14lm/w	3000K	matt white
● 671177	ILS14PLLX840NW02	14W	1600lm	114.29lm/w	4000K	matt white
● 671178	ILS14PLLX850DL02	14W	1650lm	117.86lm/w	5000K	matt white
● 671179	ILS14PLLX830WW03	14W	1250lm	89.29lm/w	3000K	matt black
● 671180	ILS14PLLX840NW03	14W	1350lm	96.43lm/w	4000K	matt black
● 671181	ILS14PLLX850DL03	14W	1400lm	100lm/w	5000K	matt black

LED Pendant Linear Luminaire (X-Shape)

Technical Operating & Electrical Data

Input Voltage & Frequency	AC220-240V, 50/60Hz
IP Ratings	IP20
Body Material	Aluminum
Beam Angle	110°
Fixed or Adjustable	Adjustable
Dimming	Non-Dimmable
Life Span	30000h

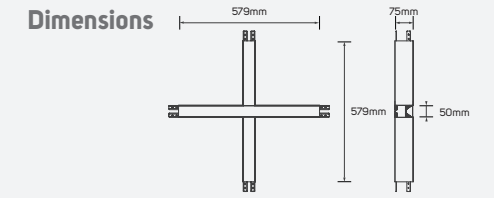
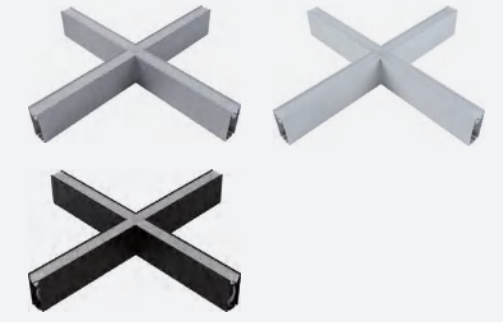

Diffuser

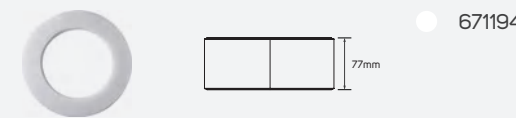

671194

■ Iron

Connector

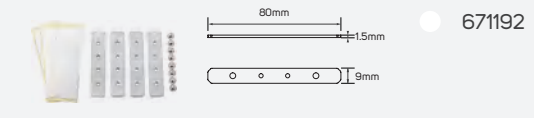

671192

■ Flexible PC

Connector

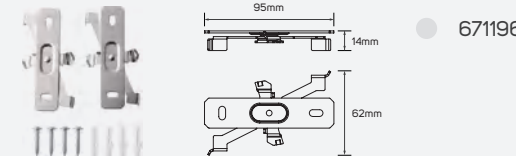

671196

■ Flexible PC

Connector

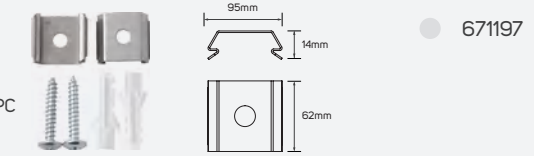

671197

■ Stainless Steel

Connector

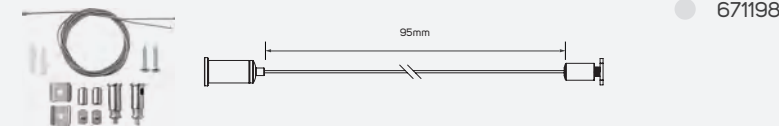

671198

■ Stainless Steel+Iron

Family Product List

Code No.	Model No.	Power	Lumen	Efficacy	CCT	Body Color
● 671182	ILS30PLLX830WW01	30W	3250lm	108.33lm/w	3000K	Silver
● 671183	ILS30PLLX840NW01	30W	3450lm	115lm/w	4000K	Silver
● 671184	ILS30PLLX850DL01	30W	3550lm	118.33lm/w	5000K	Silver
● 671185	ILS30PLLX830WW02	30W	3250lm	108.33lm/w	3000K	matt white
● 671186	ILS30PLLX840NW02	30W	3450lm	115lm/w	4000K	matt white
● 671187	ILS30PLLX850DL02	30W	3550lm	118.33lm/w	5000K	matt white
● 671188	ILS30PLLX830WW03	30W	3050lm	101.67lm/w	3000K	matt black
● 671189	ILS30PLLX840NW03	30W	3200lm	106.67lm/w	4000K	matt black
● 671190	ILS30PLLX850DL03	30W	3300lm	110lm/w	5000K	matt black





Track

Artique

Technical Operating & Electrical Data

Input Voltage & Frequency	AC220-240V, 50/60Hz
IP Rating	IP20
Mounting Type	Recessed

Areas of Application

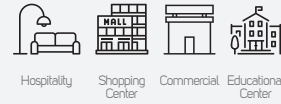

Connector Specifications

Connector

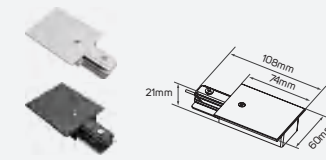

- 671205 Max.10A
- 671206 Max.10A
- PC+Copper

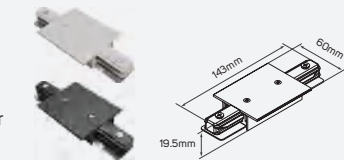

- 671207 Max.10A
- 671208 Max.10A
- PC+Copper

Connector

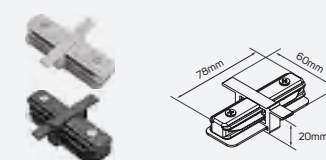

- 671209 Max.10A
- 671210 Max.10A
- PC+Copper

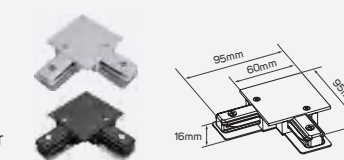

- 671211 Max.10A
- 671212 Max.10A
- PC+Copper

Connector

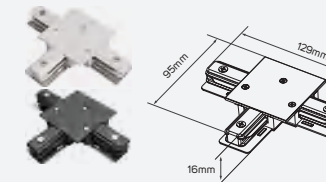

- 671213 Max.10A
- 671214 Max.10A
- PC+Copper

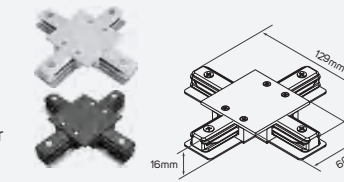

- 671215 Max.10A
- 671216 Max.10A
- PC+Copper

Connector

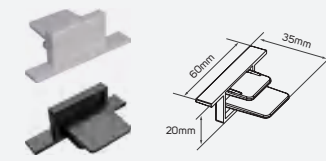

- 671217 Max.10A
- 671218 Max.10A
- PC

Dimensions Options

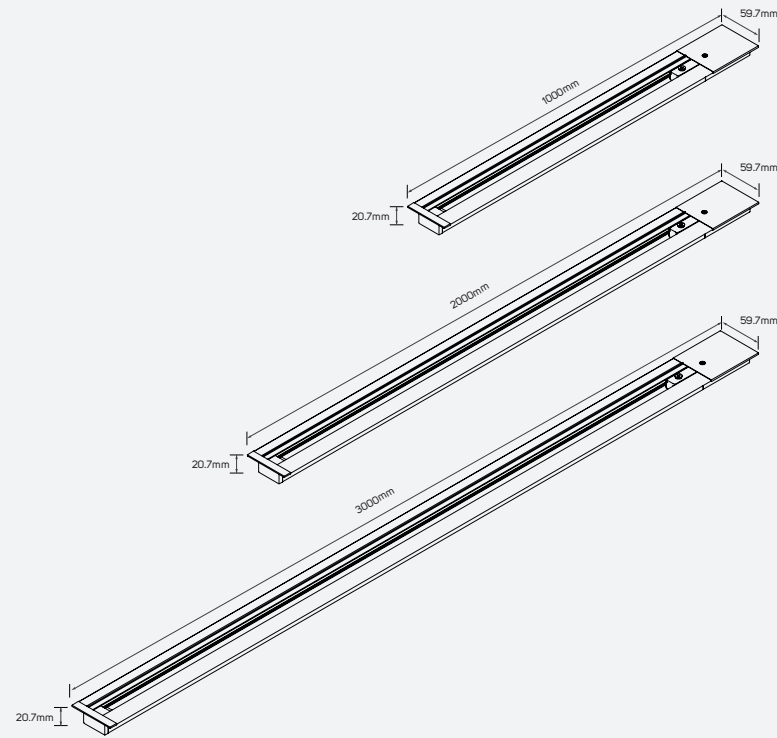

Family Product List

■ Aluminum+PVC+Copper

IP 20 AC220-240V

Code No.	Current Capacity
● 671199	Max.10A
● 671200	Max.10A
● 671201	Max.10A
● 671202	Max.10A
● 671203	Max.10A
● 671204	Max.10A

Artique

Technical Operating & Electrical Data

Input Voltage & Frequency	AC220-240V, 50/60Hz
IP Rating	IP20
Mounting Type	Recessed

Areas of Application

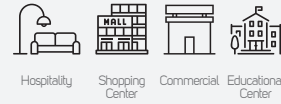

Dimensions Options

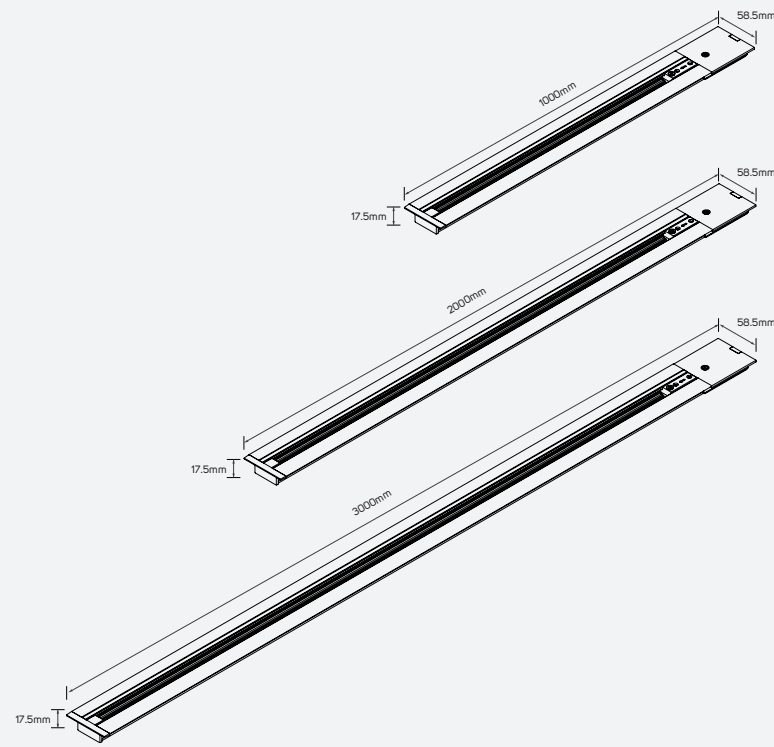

Connector Specifications

Connector

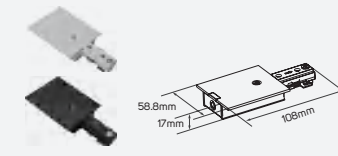

- 671225 Max.10A
- 671226 Max.10A
- PC+Copper

Connector

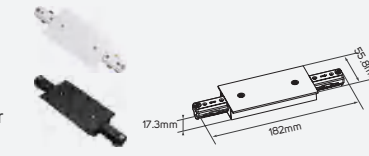

- 671227 Max.10A
- 671228 Max.10A
- PC+Copper

Connector

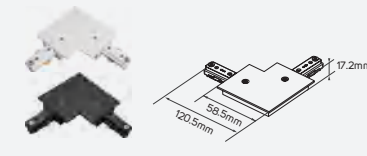

- 671229 Max.10A
- 671230 Max.10A
- PC+Copper

Connector

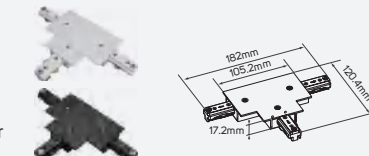

- 671231 Max.10A
- 671232 Max.10A
- PC+Copper

Connector

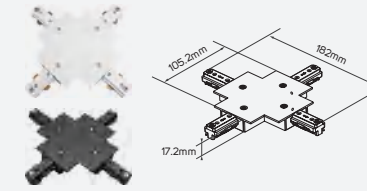

- 671233 Max.10A
- 671234 Max.10A
- PC+Copper

Connector

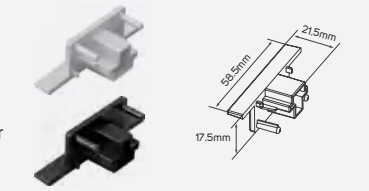

- 671235 Max.10A
- 671236 Max.10A
- PC

Family Product List

■ Aluminum+PVC+Pure Copper

IP 20 AC220-240V

Code No.	Current Capacity
● 671219	Max.10A
● 671220	Max.10A
● 671221	Max.10A
● 671222	Max.10A
● 671223	Max.10A
● 671224	Max.10A

Galactic

Technical Operating & Electrical Data

Input Voltage & Frequency	AC220-240V, 50/60Hz
IP Rating	IP20
Mounting Type	Recessed

Areas of Application

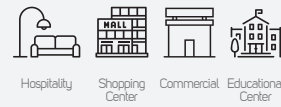

Dimensions Options

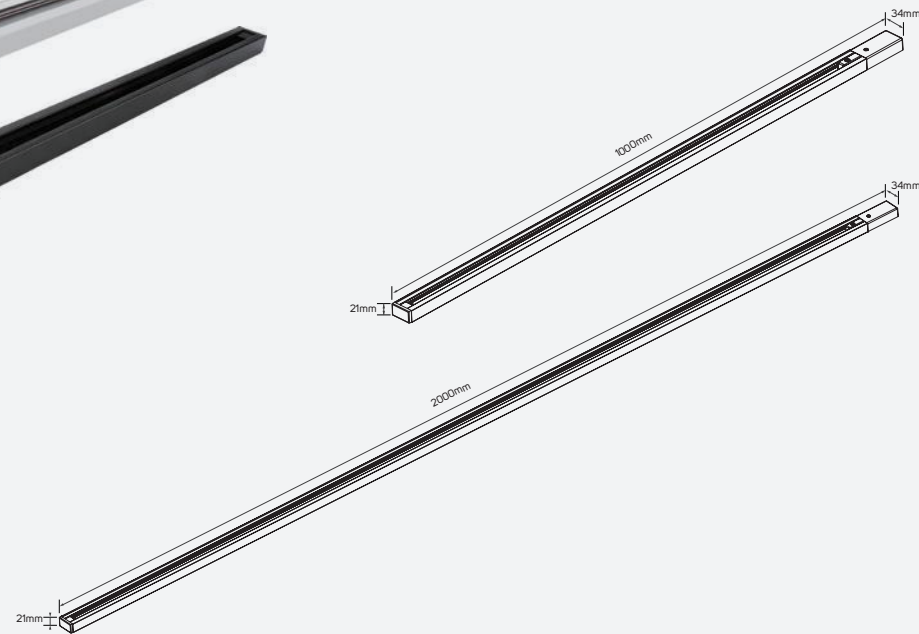

Connector Specifications

Connector

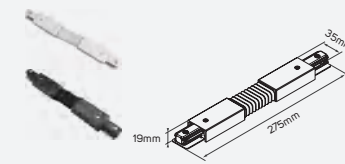

- 612468 Max.10A
- 612469 Max.10A
- PC+Copper

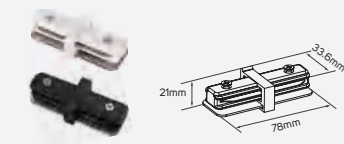

- 611455 Max.10A
- 611456 Max.10A
- PC+Copper

Connector

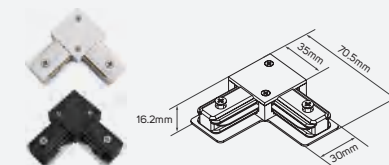

- 611457 Max.10A
- 611458 Max.10A
- PC+Copper

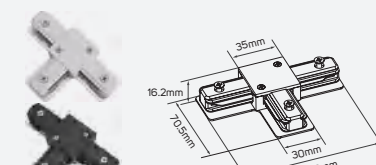

- 611459 Max.10A
- 611460 Max.10A
- PC+Copper

Connector

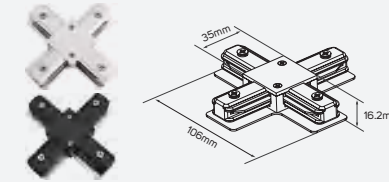

- 611461 Max.10A
- 611462 Max.10A
- PC+Copper



- 611731 Max.10A
- 611732 Max.10A
- Aluminum+PC+Steel

Family Product List

■ Aluminum+PVC+Pure Copper

IP 20 AC220-240V

Code No.	Current Capacity
● 612470	Max.10A
● 612471	Max.10A
● 612472	Max.10A
● 612473	Max.10A

Galactic

Technical Operating & Electrical Data

Input Voltage & Frequency	AC220-240V, 50/60Hz
IP Rating	IP20
Mounting Type	Recessed

Areas of Application

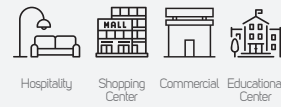

Connector Specifications

Connector

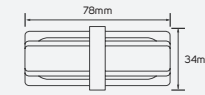

- 613354 Max.10A
- 613355 Max.10A
- Copper + Plastic

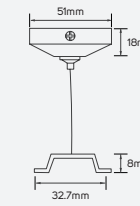

- 613356 Max.10A
- 613357 Max.10A
- Aluminum +PC+Steel

Connector

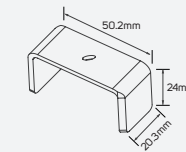

- 613362 Max.10A
- Metal

Dimensions Options

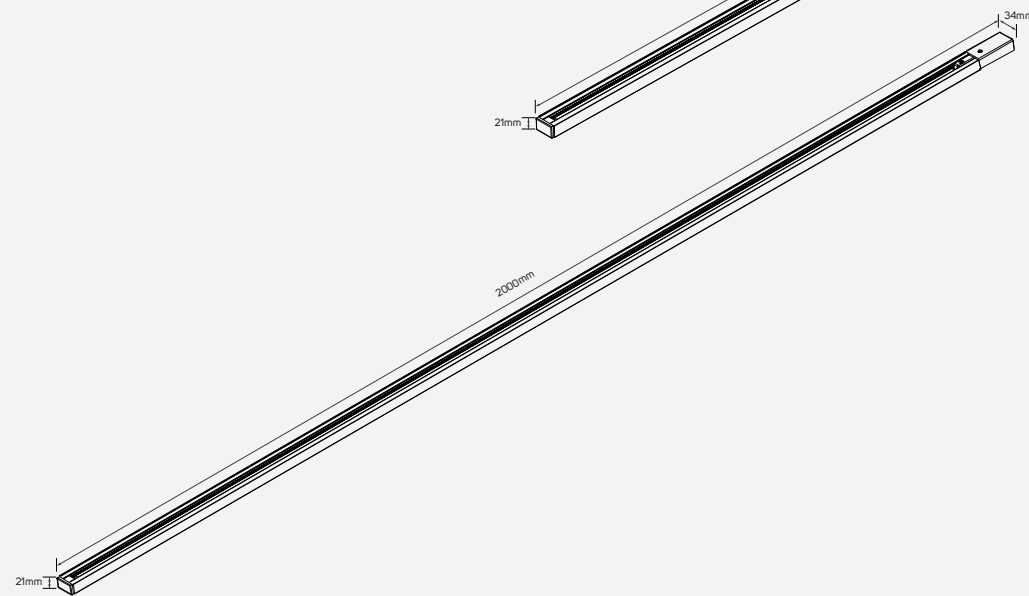
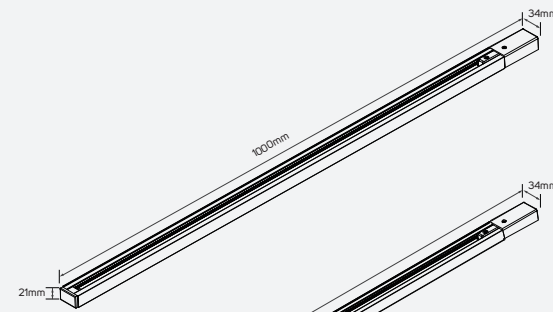

Family Product List

■ Aluminum+PVC+Pure Copper

IP 20 AC220-240V

Code No.	Current Capacity
● 613358	Max.10A
● 613359	Max.10A
● 613360	Max.10A
● 613361	Max.10A

Galactic

Technical Operating & Electrical Data

Input Voltage & Frequency	AC220-240V, 50/60Hz
IP Rating	IP20
Mounting Type	Recessed

Areas of Application

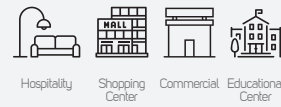

Dimensions Options

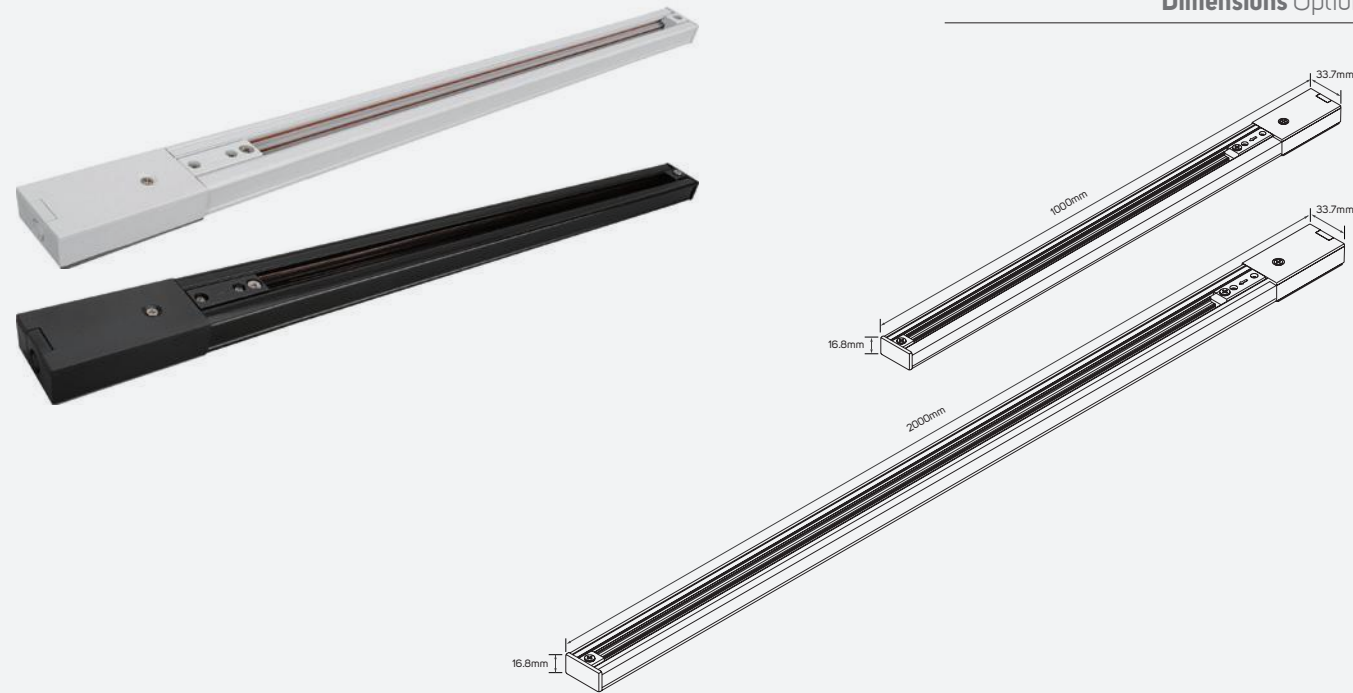

Connector Specifications

Connector

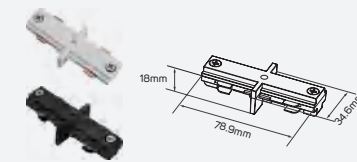

- 612776 Max.10A
- 612777 Max.10A
- PC+Copper

Connector

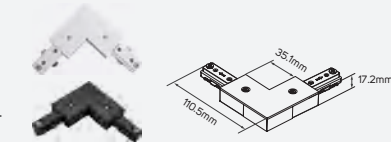

- 612778 Max.10A
- 612779 Max.10A
- PC+Copper

Connector

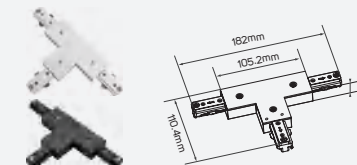

- 612780 Max.10A
- 612781 Max.10A
- PC+Copper

Connector

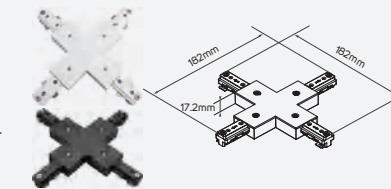

- 612782 Max.10A
- 612783 Max.10A
- PC+Copper

Connector



- 612784 Max.10A
- 612785 Max.10A
- PC+Steel

Family Product List

■ Aluminum+PVC+Pure Copper

IP 20 AC220-240V

Code No.	Current Capacity
● 612772	Max.10A
● 612773	Max.10A
● 612774	Max.10A
● 612775	Max.10A

Galactic

Technical Operating & Electrical Data

Input Voltage & Frequency	AC220-240V, 50/60Hz
IP Rating	IP20
Mounting Type	Recessed



Areas of Application

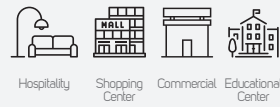

Dimensions Options

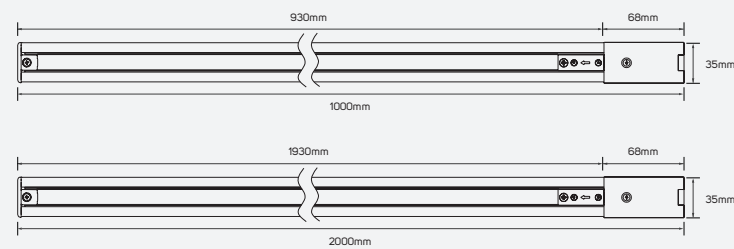

Connector Specifications

Connector

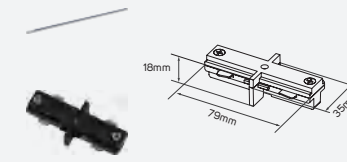

- 613443 Max.10A
- 613444 Max.10A
- PC+Copper

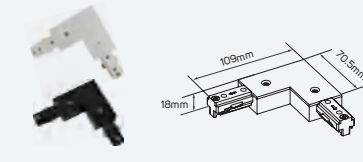

- 613445 Max.10A
- 613446 Max.10A
- PC+Copper

Connector

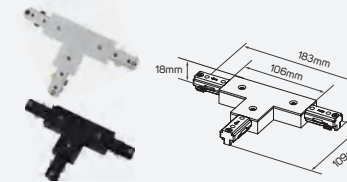

- 613447 Max.10A
- 613448 Max.10A
- PC+Copper

Connector

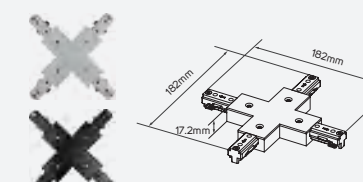

- 613449 Max.10A
- 613450 Max.10A
- PC+Copper

Family Product List

■ Aluminum

IP 20 AC220-240V

Code No.	Current Capacity
● 613439	Max.10A
● 613440	Max.10A
● 613441	Max.10A
● 613442	Max.10A



LED Lamp

- GU10 Lamp
- LED Decorative Lamp
- Flying Lamp
- LED Smart Lamp
- LED Non-Directional Lamp
- LED Filament Lamp
- LED Filament E27 Lamp
- GX53
- LED AR111
- LED 50 Module (GU10)
- LED 35 Module (MR11)
- LED Filament Lamp (PIR Sensor)
- LED Filament Lamp (Microwave Sensor)
- LED T8 Glass Tube Light



GU10 Lamp

EclipseGlow

Technical Operating & Electrical Data

Input Voltage & Frequency	AC220-240V, 50/60Hz
Rated CRI	95
Life Span	40,000h
Displacement Factor	0.9
Ingress Protection Rating	IP20
Dimming	Dimmable
Ambient Temperature	-20°~+45° C
Switching Cycle ON/OFF	100,000
Protection Class	Class II

Areas of Application

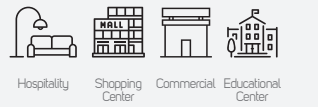

Dimensions Options

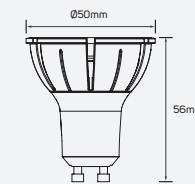

Family Product List

Code No.	Model No.	Power	Beam Angle	CCT	Lumen	Efficacy	Current
● 612546	ILS7D10GU10L927WW01	7W	10°	2700k	360lm	51lm/W	38mA
● 612547	ILS7D10GU10L930WW01	7W	10°	3000k	380lm	54lm/W	38mA
● 612548	ILS7D10GU10L940NW01	7W	10°	4000k	400lm	57lm/W	38mA
● 612549	ILS7D10GU10L950DL01	7W	10°	5000k	410lm	59lm/W	38mA
● 612550	ILS7D24GU10L927WW01	7W	24°	2700K	470lm	67lm/W	38mA
● 612551	ILS7D24GU10L930WW01	7W	24°	3000K	500lm	71lm/W	38mA
● 612552	ILS7D24GU10L940NW01	7W	24°	4000K	540lm	77lm/W	38mA
● 612553	ILS7D24GU10L950DL01	7W	24°	5000K	560lm	80lm/W	38mA
● 612554	ILS7D36GU10L927WW01	7W	36°	2700K	460lm	66lm/W	38mA
● 612555	ILS7D36GU10L930WW01	7W	36°	3000K	490lm	70lm/W	38mA
● 612556	ILS7D36GU10L940NW01	7W	36°	4000K	530lm	76lm/W	38mA
● 612557	ILS7D36GU10L950DL01	7W	36°	5000K	550lm	79lm/W	38mA
● 612558	ILS7D60GU10L927WW01	7W	60°	2700K	440lm	63lm/W	38mA
● 612559	ILS7D60GU10L930WW01	7W	60°	3000K	460lm	66lm/W	38mA
● 612560	ILS7D60GU10L940NW01	7W	60°	4000K	500lm	71lm/W	38mA
● 612561	ILS7D60GU10L950DL01	7W	60°	5000K	530lm	76lm/W	38mA

Vivid

PRODUCT INFORMATION

- LED spots GU10 are a perfect fit for spot lighting and deliver warm halogen light.
- Deliver significant energy savings and minimize maintenance cost.
- ILLUS LED GU10 lamp gives the customer the flexibility to choose between 4 CCT & 4 different beam angles Based on their specific need with lumen package from 360 lm to 560 lm.

BENEFITS

- Variety of beam angles.
- Up to %80 energy saving compared with halogen lamps.
- Lower maintenance costs.
- Longer Life Time.

FEATURES

- High CRI>95.
- Efficacy up to 80 lm/w.
- Long life span 40,000h
- Operating voltage AC220 – 240V.
- Dimmable.
- UV – IR – free light.



GU10 Lamp

LuminanceLink

Technical Operating & Electrical Data

Input Voltage & Frequency	AC220-240V, 50/60Hz
Rated CRI	95
Life Span	25,000h
Displacement Factor	0.5
Ingress Protection Rating	IP20
Dimming	Non-Dimmable
Ambient Temperature	-20°~+45° C
Switching Cycle ON/OFF	100,000
Protection Class	Class II

Areas of Application

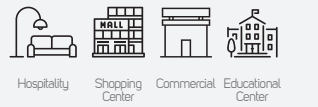

Dimensions Options

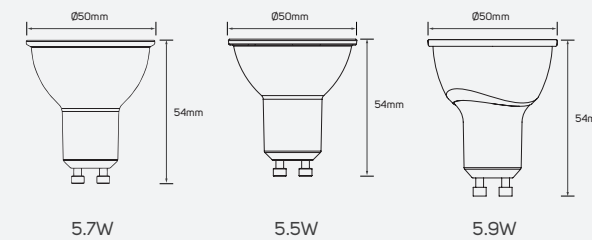

Family Product List

Code No.	Model No.	Power	Beam Angle	CCT	Lumen	Efficacy
612447	ILS460GU10L927WW01	5.7W	36°	2700k	460lm	81lm/W
612448	ILS470GU10L930WW01	5.7W	36°	3000k	470lm	82lm/W
612449	ILS480GU10L940NW01	5.7W	36°	4000k	480lm	84lm/W
612450	ILS490GU10L950DL01	5.7W	36°	5000k	490lm	86lm/W
612599	ILS440DGU10L927WW01	5.5W	36°	2700k	440lm	80lm/w
612600	ILS450DGU10L930WW01	5.5W	36°	3000k	450lm	81.82lm/w
612601	ILS470DGU10L940NW01	5.5W	36°	4000k	470lm	85.45lm/w
612602	ILS480DGU10L950DL01	5.5W	36°	5000k	480lm	87.27lm/w
611765	ILS430SL927WW01	5.9W	36°	2700k	430lm	72.88lm/W
611766	ILS430SL930WW01	5.9W	36°	3000k	430lm	72.88lm/W
611767	ILS450SL940NW01	5.9W	36°	4000k	450lm	76.27lm/W
611768	ILS450SL950DL01	5.9W	36°	5000k	450lm	76.27lm/W

Vivid

PRODUCT INFORMATION

- LEDspots GU10 are designed as a retrofit replacement for halogen spots.
- Deliver significant energy savings and minimize initial investment.
- ILLUS LED GU10 lamp gives the customer the flexibility to choose between 4 CCT based on their specific need with lumen package from 430 lm to 490 lm.

BENEFITS

- Up to %90 energy saving compared with traditional halogen lamps.
- Lower maintenance costs.
- Low initial investment.

FEATURES

- High CRI>95.
- Efficacy up to 87 lm/w.
- Long life span 25,000h
- Operating voltage AC100 - 240V.
- Non - dimmable.
- UV - IR - free light.



GU10 Lamp

PureRadiance

Technical Operating & Electrical Data

Input Voltage & Frequency	AC220-240V, 50/60Hz
Rated CRI	95
Life Span	25,000h
Displacement Factor	0.5
Ingress Protection Rating	IP20
Dimming	Non-Dimmable
Ambient Temperature	-20°~+45° C
Switching Cycle ON/OFF	100,000
Protection Class	Class II

Areas of Application

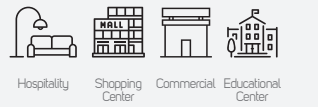

Dimensions Options

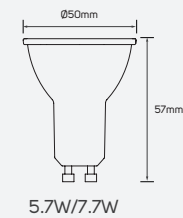

Family Product List

Code No.	Model No.	Power	Beam Angle	CCT	Lumen	Efficacy
612631	ILS36D7.7DGU10L927WW01	7.7W	36°	2700K	600lm	77.92lm/W
612632	ILS36D7.7DGU10L930WW01	7.7W	36°	3000K	610lm	79.22lm/W
612633	ILS36D7.7DGU10L940NW01	7.7W	36°	4000K	640lm	83.12lm/W
612634	ILS36D7.7DGU10L950DL01	7.7W	36°	5000K	650lm	84.42lm/W
612635	ILS60D7.7DGU10L927WW01	7.7W	60°	2700K	500lm	64.94lm/W
612636	ILS60D7.7DGU10L930WW01	7.7W	60°	3000K	510lm	66.23lm/W
612637	ILS60D7.7DGU10L940NW01	7.7W	60°	4000K	530lm	68.83lm/W
612638	ILS60D7.7DGU10L950DL01	7.7W	60°	5000K	540lm	70.13lm/W
612639	ILS100D7.7DGU10L927WW01	7.7W	100°	2700K	560lm	72.73lm/W
612640	ILS100D7.7DGU10L930WW01	7.7W	100°	3000K	570lm	74.03lm/W
612641	ILS100D7.7DGU10L940NW01	7.7W	100°	4000K	590lm	76.62lm/W
612642	ILS100D7.7DGU10L950DL01	7.7W	100°	5000K	600lm	77.92lm/W
612643	ILS60D5.7GU10L927WW01	5.7W	60°	2700K	400lm	70.18lm/W
612644	ILS60D5.7GU10L930WW01	5.7W	60°	3000K	410lm	71.93lm/W
612645	ILS60D5.7GU10L940NW01	5.7W	60°	4000K	430lm	75.44lm/W
612646	ILS60D5.7GU10L950DL01	5.7W	60°	5000K	440lm	77.19lm/W
612647	ILS110D5.7GU10L927WW01	5.7W	110°	2700K	410lm	71.93lm/W
612648	ILS110D5.7GU10L930WW01	5.7W	110°	3000K	420lm	73.68lm/W
612649	ILS110D5.7GU10L940NW01	5.7W	110°	4000K	440lm	77.19lm/W
612650	ILS110D5.7GU10L950DL01	5.7W	110°	5000K	450lm	78.95lm/W

Vivid

PRODUCT INFORMATION

- LEDspots GU10 are designed as a retrofit replacement for halogen spots.
- Deliver significant energy savings and minimize initial investment.
- ILLUS LED GU10 lamp gives the customer the flexibility to choose between 20 models based on their specific need with lumen package from 400 lm to 650 lm.

BENEFITS

- Up to 90% energy saving compared with traditional halogen lamps.
- Lower maintenance costs.
- Low initial investment.

FEATURES

- High CRI>95.
- Efficacy up to 84lm/w.
- Long life span 25,000 hrs.
- Wide operating voltage AC220 – 240V.
- Dimmable
- UV – and IR – free light.



Vivid

PRODUCT INFORMATION

- LEDspots GU10 are designed as a retrofit replacement for halogen spots.
- Deliver significant energy savings and minimize initial investment.
- ILLUS LED GU10 lamp gives the customer the flexibility to choose between 4 CCT based on their specific need with lumen package from 450 lm to 510 lm.

BENEFITS

- Up to %90 energy saving compared with traditional halogen lamps.
- Lower maintenance costs.
- Low initial investment.

FEATURES

- High CRI>90.
- Efficacy up to 106 lm/w.
- Long life span 25,000h
- Operating voltage AC220 – 240V.
- Non – dimmable.
- UV – IR – free light.

GU10 Lamp

VividGlow

Technical Operating & Electrical Data

Input Voltage & Frequency	AC220-240V, 50/60Hz
Rated CRI	90
Life Span	25,000h
Displacement Factor	0.95
Ingress Protection Rating	IP20
Dimming	Non-Dimmable
Ambient Temperature	-20°~+45° C
Switching Cycle ON/OFF	100,000
Protection Class	Class II

Dimensions Options

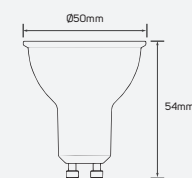

Areas of Application

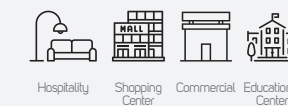

Family Product List

Code No.	Model No.	Power	Beam Angle	CCT	Lumen	Efficacy	Current
612459	ILS370GU10L927WW01	4.8W	40°	2700k	450lm	94lm/W	38mA
612460	ILS380GU10L930WW01	4.8W	40°	3000k	470lm	98lm/W	39mA
612461	ILS410GU10L940NW01	4.8W	40°	4000k	500lm	104lm/W	37mA
612462	ILS420GU10L950DL01	4.8W	40°	5000k	510lm	106lm/W	37mA



LED Decorative Lamp

Stellar

Technical Operating & Electrical Data

Input Voltage & Frequency	AC220-240V, 50/60Hz
Power	2.3W
Rated CRI	95
Life Span	40,000h
Displacement Factor	0.4
Ingress Protection Rating	IP20
Dimming	Non-Dimmable

Glass
40000h

Areas of Application



Body Color Options



Clear

Shape Options



Dimensions Options

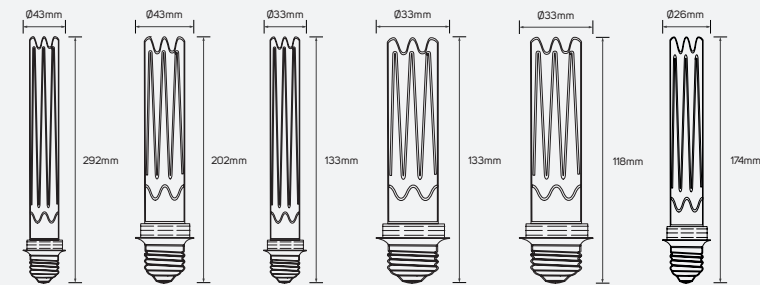

Family Product List

Code No.	Model No.	CCT	Lumen	Efficacy	Dimensions
○ 612180	ILSDLYS32.3WA00	1800K	90lm	39lm/w	Ø43x292mm
○ 612193	ILSDLYS32.3WA00	1800K	90lm	39lm/w	Ø43x265mm
○ 612212	ILSDLYS32.3WA00	1800K	90lm	39lm/w	Ø43x202mm
○ 612240	ILSDLYS22.3WA00	1800K	90lm	39lm/w	Ø33x133mm
○ 612265	ILSDLYS22.3WA00	1800K	90lm	39lm/w	Ø33x118mm
○ 612281	ILSDLYS12WA00	1800K	60lm	30lm/w	Ø26x174mm

LED Decorative Lamp

PRODUCT INFORMATION

- Unique and innovative lamp design & construction.
- A perfect choice for hospitality, decorative and mood lighting applications.
- Transforms your home with a perfect blend of warm white light and a lean.
- Distributed light with trendy and stylish charm for a welcoming harmony in your space.

BENEFITS

- 90% energy saving.
- Very long lifetime that reduces the need for replacement.
- Easy replacement of classic conventional lamps.

FEATURES

- High CRI>95.
- Efficacy up to 39 lm/w.
- Long life span 40,000 hrs.
- Wide operating voltage AC220 – 240V.
- Non-Dimmable.

Family Product List

Code No.	Model No.	CCT	Lumen	Efficacy	Dimensions
○ 612180	ILSDLYS32.3WA00	1800K	90lm	39lm/w	∅43x292mm

Accessories Options ■ Glass

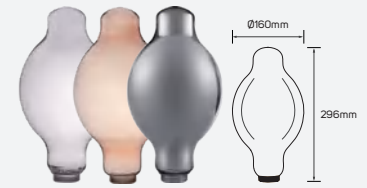

- 612181 ILS30255CLRLCVR01
- 612182 ILS30255ABRLCVR01
- 612183 ILS30255ESGLCVR01

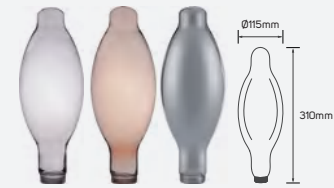

- 612184 ILS30255CLRLCVR02
- 612185 ILS30255ABRLCVR02
- 612186 ILS30255ESGLCVR02



- 612187 ILS30255CLRLCVR03
- 612188 ILS30255ABRLCVR03
- 612189 ILS30255ESGLCVR03



- 612190 ILS30255CLRLCVR02
- 612191 ILS30255ABRLCVR02
- 612192 ILS30255ESGLCVR02

Code No.	Model No.	CCT	Lumen	Efficacy	Dimensions
○ 612193	ILSDLYS32.3WA00	1800K	90lm	39lm/w	∅43x265mm

Accessories Options ■ Glass



- 612194 ILS30230CLRLCVR01
- 612195 ILS30230ABRLCVR01
- 612196 ILS30230ESGLCVR01



- 612197 ILS30230CLRLCVR02
- 612198 ILS30230ABRLCVR02
- 612199 ILS30230ESGLCVR02

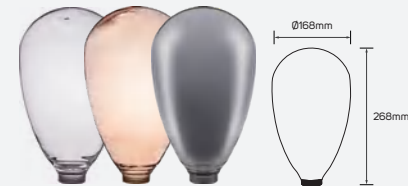

- 612200 ILS30230CLRLCVR03
- 612201 ILS30230ABRLCVR03
- 612202 ILS30230ESGLCVR03



- 612203 ILS30230CLRLCVR04
- 612204 ILS30230ABRLCVR04
- 612205 ILS30230ESGLCVR04

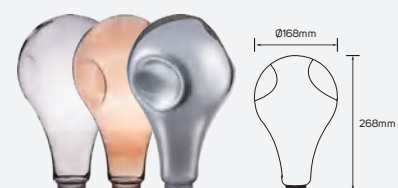

- 612206 ILS30230CLRLCVR05
- 612207 ILS30230ABRLCVR05
- 612208 ILS30230ESGLCVR05



- 612209 ILS30230CLRLCVR06
- 612210 ILS30230ABRLCVR06
- 612211 ILS30230ESGLCVR06

Family Product List

Code No.	Model No.	CCT	Lumen	Efficacy	Dimensions
○ 612212	ILSDLYS32.3WA00	1800K	90lm	39lm/w	∅43x202mm

Accessories Options ■ Glass



- 612213 ILS30165CLRLCVR01
- 612214 ILS30165ABRLCVR01
- 612215 ILS30165ESGLCVR01

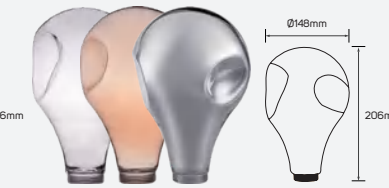

- 612216 ILS30165CLRLCVR02
- 612217 ILS30165ABRLCVR02
- 612218 ILS30165ESGLCVR02

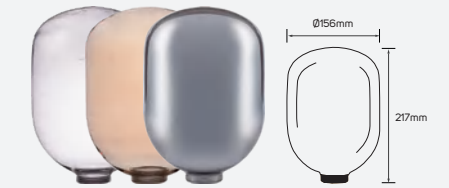

- 612219 ILS30165CLRLCVR03
- 612220 ILS30165ABRLCVR03
- 612221 ILS30165ESGLCVR03

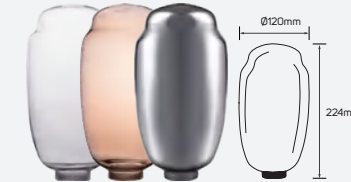

- 612222 ILS30165CLRLCVR04
- 612223 ILS30165ABRLCVR04
- 612224 ILS30165ESGLCVR04

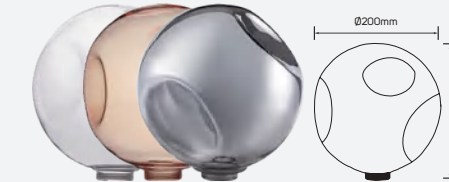

- 612225 ILS30165CLRLCVR05
- 612226 ILS30165ABRLCVR05
- 612227 ILS30165ESGLCVR05



- 612228 ILS30165CLRLCVR06
- 612229 ILS30165ABRLCVR06
- 612230 ILS30165ESGLCVR06



- 612231 ILS30165CLRLCVR07
- 612232 ILS30165ABRLCVR07
- 612233 ILS30165ESGLCVR07



- 612234 ILS30165CLRLCVR08
- 612235 ILS30165ABRLCVR08
- 612236 ILS30165ESGLCVR08

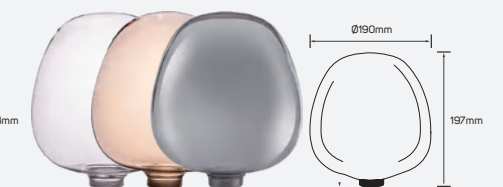

- 612237 ILS30165CLRLCVR09
- 612238 ILS30165ABRLCVR09
- 612239 ILS30165ESGLCVR09

Family Product List

Code No.	Model No.	CCT	Lumen	Efficacy	Dimensions
○ 612240	ILSDLYS22.3WA00	1800K	90lm	39lm/w	Ø33x133mm

Accessories Options

■ Glass



- 612241 ILS25100CLRLCVR01
- 612242 ILS25100ABRLCVR01
- 612243 ILS25100ESGLCVR01
- 612244 ILS25100CLRLCVR02
- 612245 ILS25100ABRLCVR02
- 612246 ILS25100ESGLCVR02
- 612247 ILS25100CLRLCVR03
- 612248 ILS25100ABRLCVR03
- 612249 ILS25100ESGLCVR03



- 612250 ILS25100CLRLCVR04
- 612251 ILS25100ABRLCVR04
- 612252 ILS25100ESGLCVR04
- 612253 ILS25100CLRLCVR05
- 612254 ILS25100ABRLCVR05
- 612255 ILS25100ESGLCVR05
- 612256 ILS25100CLRLCVR06
- 612257 ILS25100ABRLCVR06
- 612258 ILS25100ESGLCVR06



- 612259 ILS25100CLRLCVR07
- 612260 ILS25100ABRLCVR07
- 612261 ILS25100ESGLCVR07
- 612262 ILS25100CLRLCVR08
- 612263 ILS25100ABRLCVR08
- 612264 ILS25100ESGLCVR08

Family Product List

Code No.	Model No.	CCT	Lumen	Efficacy	Dimensions
○ 612265	ILSDLYS22.3WA00	1800K	90lm	39lm/w	Ø33x118mm

Accessories Options

■ Glass



- 612266 ILS25085CLRLCVR01
- 612267 ILS25085ABRLCVR01
- 612268 ILS25085ESGLCVR01
- 612269 ILS25085CLRLCVR02
- 612270 ILS25085ABRLCVR02
- 612271 ILS25085ESGLCVR02
- 612219 ILS30165CLRLCVR03
- 612220 ILS30165ABRLCVR03
- 612221 ILS30165ESGLCVR03



- 612272 ILS25085CLRLCVR03
- 612273 ILS25085ABRLCVR03
- 612274 ILS25085ESGLCVR03
- 612275 ILS25085CLRLCVR04
- 612276 ILS25085ABRLCVR04
- 612277 ILS25085ESGLCVR04
- 612278 ILS25085CLRLCVR05
- 612279 ILS25085ABRLCVR05
- 612280 ILS25085ESGLCVR05

Code No.	Model No.	CCT	Lumen	Efficacy	Dimensions
○ 612281	ILSDLYS12WA00	1800K	60lm	30lm/w	Ø26x174mm

Accessories Options

■ Glass

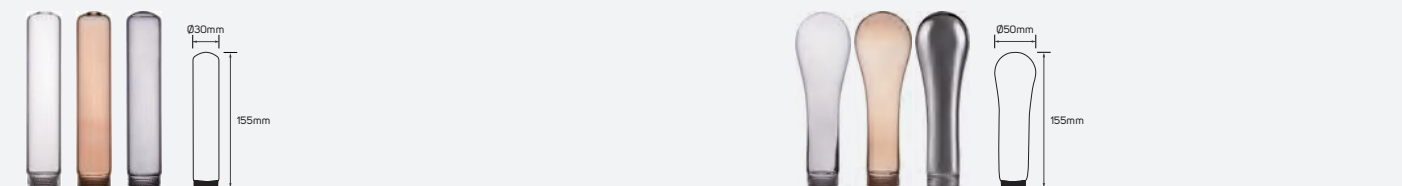

- 612282 ILS16140CLRLCVR01
- 612283 ILS16140ABRLCVR01
- 612284 ILS16140SGLCVR01
- 612285 ILS16140CLRLCVR02
- 612286 ILS16140ABRLCVR02
- 612287 ILS16140SGLCVR02

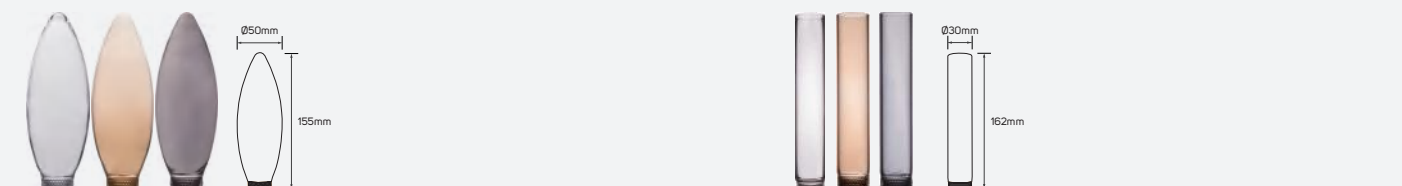

- 612288 ILS16140CLRLCVR03
- 612289 ILS16140ABRLCVR03
- 612290 ILS16140SGLCVR03
- 612291 ILS16140CLRLCVR04
- 612292 ILS16140ABRLCVR04
- 612293 ILS16140SGLCVR04





Flying Lamp

Flying

Technical Operating & Electrical Data

Input Voltage & Frequency	AC220-240V, 50/60Hz
Rated CRI	95
Life Span	25,000h
Ingress Protection Rating	IP20
Dimming	Non-Dimmable

Areas of Application

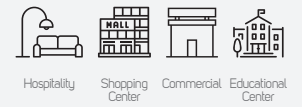

Body Color Options



White Black/White

Shape Options



Dimensions Options

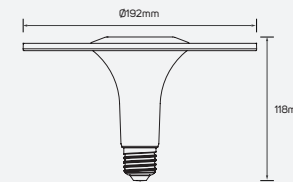

Family Product List

Code No.	Model No.	Power	Beam Angle	CCT	Lumen	Efficacy
612544	ILS850DECL927WW01	10W	340°	2700K	850lm	85lm/W
612545	ILS850DECL927WW02	10W	340°	2700K	850lm	85lm/W

Flying

PRODUCT INFORMATION

- Transform your home with a perfect blend of warm white light and a lean.
- Enjoy soft and evenly distributed light for a welcoming harmony in your space.
- ILLUS LED DECOFLY lamp gives the customer the flexibility to choose between 2 models
- Based on their specific need with lumen package up to 850 lm.

BENEFITS

- Around %90 energy saving.
- Very long lifetime that reduces the need for replacement.
- Easy replacement of classic conventional lamps.

FEATURES

- High CRI>95.
- Efficacy up to 85 lm/w.
- Long life span 25,000 hrs.
- Wide operating voltage AC100 – 240V.
- Non-Dimmable.



LED Smart Lamp

Velvet Visions

Technical Operating & Electrical Data

Input Voltage & Frequency	AC220-240V, 50/60Hz
Life Span	15,000h
Ingress Protection Rating	IP20
Dimming	Dimmable

Areas of Application



Body Color Options



White

Shape Options



Dimensions Options

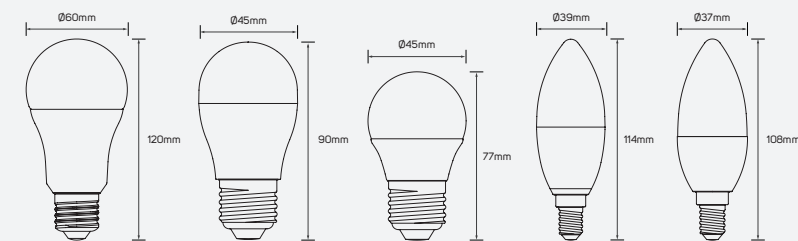

Family Product List

Code No.	Model No.	Power	Beam Angle	CCT	Lumen	Efficacy
612963	ILS10A60E27L91865WB01	10W	220°	1800K-6500K	950lm@6500K	95lm/W
612964	ILS10A60E27L92765RGBWB01	10W	220°	2700K-6500K+RGB	806lm@2700K	80.60lm/W
612967	ILS4.9C37E14L91865WB01	4.9W	220°	1800K-6500K	450lm@6500K	91.84lm/W
612968	ILS4.9C37E14L92765RGBWB01	4.9W	220°	2700K-6500K+RGB	380lm@2700K	77.55lm/W
612969	ILS4.9C45E27L91865WB01	4.9W	160°	1800K-6500K	470lm@6500K	95.92lm/W
612970	ILS4.9C45E27L92765RGBWB01	4.9W	160°	2700K-6500K+RGB	400lm@2700K	81.63lm/W

Miracle

PRODUCT INFORMATION

- Easy plug and play, works with your existing Wi-Fi.
- Voice control with google assistant, Alexa or Siri shortcuts.
- ILLUS LED SMART FILAMENT Lamp gives the customer the flexibility to choose between 6 models based on their specific need with lumen package from 380 lm to 950 lm.

BENEFITS

- Automate your light with schedules.
- Energy monitoring.
- Tunable warm to cool white modes.

FEATURES

- High CRI>90.
- Efficacy up to 96 lm/w.
- Long life span 15,000 hrs.
- Operating voltage AC220 - 240V.
- Dimmable.

LED Smart Lamp

Gentle

Technical Operating & Electrical Data

Input Voltage & Frequency	AC220-240V, 50/60Hz
Life Span	15,000h
Ingress Protection Rating	IP20
Dimming	Dimmable

Areas of Application

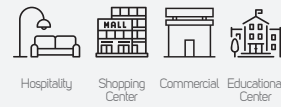

Body Color Options



White

Shape Options



Dimensions Options

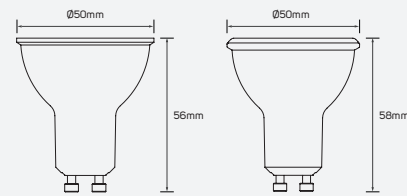

Family Product List

Code No.	Model No.	Power	Beam Angle	CCT	Lumen	Efficacy
612965	ILS4.9C21GU10L91865WB01	4.9W	36°	1800K-6500K	300lm@6500K	61.22lm/W
612966	ILS4.9C21GU10L92765RGBWB01	4.9W	36°	2700K-6500K+RGB	280lm@2700K	57.14lm/W

LED Smart Lamp

StarlightSymphony

Technical Operating & Electrical Data

Input Voltage & Frequency	AC220-240V, 50/60Hz
Life Span	15,000h
Ingress Protection Rating	IP20
Dimming	Dimmable
Beam Angle	330°

Areas of Application



Body Color Options



Clear golden

Shape Options



Dimensions Options

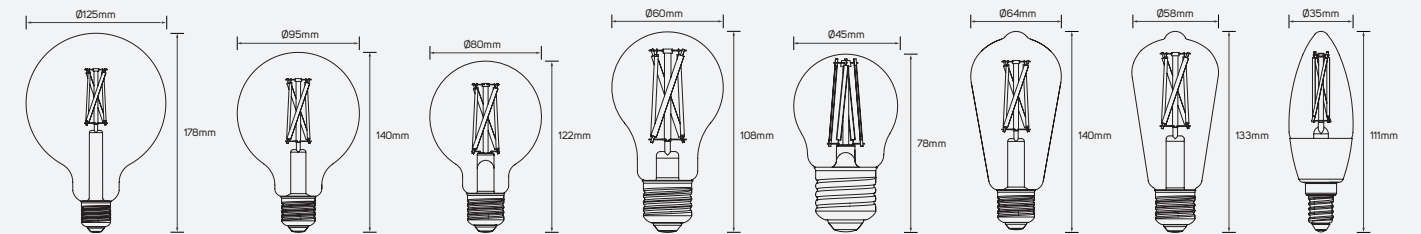

Family Product List

Code No.	Model No.	Power	CCT	Lumen	Efficacy
612971	ILS7A60E27L91865WB01	7W	1800K-6500K	806lm@6500K	115.14lm/W
612972	ILS7A60E27L91750WB01	7W	1700K-5000K	720lm@5000K	102.86lm/W
612973	ILS4.9C35E14L91865WB01	4.9W	1800K-6500K	470lm@6500K	95.92lm/W
612974	ILS4.9C35E14L91750WB01	4.9W	1700K-5000K	420lm@5000K	85.71lm/W
612975	ILS4.9C45E27L91865WB02	4.9W	1800K-6500K	470lm@6500K	95.92lm/W
612976	ILS4.9C45E27L91750WB01	4.9W	1700K-5000K	420lm@5000K	85.71lm/W
612977	ILS7G80E27L91865WB01	7W	1800K-6500K	806lm@6500K	115.14lm/W
612978	ILS7G80E27L91750WB01	7W	1700K-5000K	720lm@5000K	102.86lm/W
612979	ILS7G95E27L91865WB01	7W	1800K-6500K	806lm@6500K	115.14lm/W
612980	ILS7G95E27L91750WB01	7W	1700K-5000K	720lm@5000K	102.86lm/W
612981	ILS7G125E27L91865WB01	7W	1800K-6500K	806lm@6500K	115.14lm/W
612982	ILS7G125E27L91750WB01	7W	1700K-5000K	750lm@5000K	107.14lm/W

Family Product List

Code No.	Model No.	Power	CCT	Lumen	Efficacy
○ 612983	ILS7ST58E27L91865WB01	7W	1800K-6500K	806lm@6500K	115.14lm/W
● 612984	ILS4.9ST58E27L91750WB01	4.9W	1700K-5000K	420lm@5000K	85.71lm/W
○ 612985	ILS7ST64E27L91865WB01	7W	1800K-6500K	806lm@6500K	115.14lm/W
● 612986	ILS7ST64E27L91750WB01	7W	1700K-5000K	720lm@5000K	102.86lm/W





ColorStream

PRODUCT INFORMATION

- Combines the familiar shapes of classic incandescent bulbs with long lasting LED technology.
- Delivers beautiful warm white light while saving energy costs compared with traditional light bulbs.
- ILLUS LED NON – DIRECTIONAL Lamp gives the customer the flexibility to choose between 11 models based on their specific need with lumen package from 820 lm to 2350 lm.

BENEFITS

- Very long lifetime that reduces the need for replacement.
- Easy replacement of classic conventional lamps.

FEATURES

- High CRI>92.
- Efficacy up to 139 lm/w.
- Long life span 15,000 hrs.
- Operating voltage AC100 – 240V.
- Non – dimmable.

LED Non-Directional Lamp

Celestial Sway

Technical Operating & Electrical Data

Input Voltage & Frequency	AC220-240V, 50/60Hz
Rated CRI	92
Life Span	15,000h
Ingress Protection Rating	IP20
Dimming	Non-Dimming
Directional or Non Directional	Non-Directional
Fixed or Adjustable	Fixed

Body Color Options



Shape Options



Dimensions Options

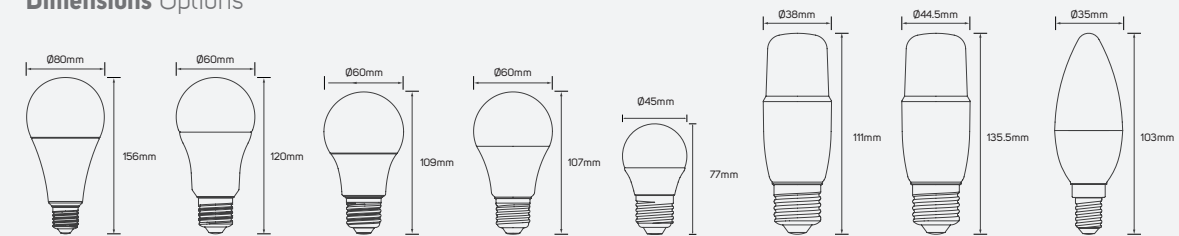

Areas of Application



Family Product List

Code No.	Model No.	Power	Beam Angle	CCT	Lumen	Efficacy
612794	ILS7.5A60E27L930WW01	7.5W	150°	3000K	820lm	109.33lm/W
612795	ILS7.5A60E27L940NW01	7.5W	150°	4000K	830lm	110.67lm/W
612796	ILS7.5A60E27L950DL01	7.5W	150°	5000K	840lm	112lm/W
612797	ILS9A60E27L930WW01	9W	150°	3000K	1030lm	114.44lm/W
612798	ILS9A60E27L940NW01	9W	150°	4000K	1050lm	116.67lm/W
612799	ILS9A60E27L950DL01	9W	150°	5000K	1060lm	117.78lm/W
612800	ILS11.5A60E27L930WW01	11.5W	150°	3000K	1520lm	132.17lm/W
612801	ILS11.5A60E27L940NW01	11.5W	150°	4000K	1550lm	134.78lm/W
612802	ILS11.5A60E27L950DL01	11.5W	150°	5000K	1600lm	139.13lm/W
612803	ILS17A80E27L930WW01	17W	150°	3000K	2300lm	135.29lm/W
612804	ILS17A80E27L940NW01	17W	150°	4000K	2350lm	138.24lm/W

Family Product List

Code No.	Model No.	Power	Beam Angle	CCT	Lumen	Efficacy
612806	ILS4.5C35E14L930WW01	4.5W	250°	3000K	450lm	100lm/W
612807	ILS4.5C35E14L940NW01	4.5W	250°	4000K	460lm	102.22lm/W
612808	ILS4.5C35E14L950DL01	4.5W	250°	5000K	470lm	104.44lm/W
612809	ILS6.2C35E14L930WW01	6.2W	250°	3000K	820lm	132.26lm/W
612810	ILS6.2C35E14L940NW01	6.2W	250°	4000K	830lm	133.87lm/W
612811	ILS6.2C35E14L950DL01	6.2W	250°	5000K	840lm	135.48lm/W
612812	ILS4.5G45E27L930WW01	4.5W	150°	3000K	460lm	102.22lm/W
612813	ILS4.5G45E27L940NW01	4.5W	150°	4000K	470lm	104.44lm/W
612814	ILS4.5G45E27L950DL01	4.5W	150°	5000K	480lm	106.67lm/W
612815	ILS6.2G45E27L930WW01	6.2W	150°	3000K	820lm	132.26lm/W
612816	ILS6.2G45E27L940NW01	6.2W	150°	4000K	830lm	133.87lm/W
612817	ILS6.2G45E27L950DL01	6.2W	150°	5000K	840lm	135.48lm/W
612818	ILS7.5T37E27L930WW01	7.5W	200°	3000K	800lm	106.67lm/W
612819	ILS7.5T37E27L940NW01	7.5W	200°	4000K	805lm	107.33lm/W
612820	ILS7.5T37E27L950DL01	7.5W	200°	5000K	810lm	108lm/W
612821	ILS9T37E27L930WW01	9W	200°	3000K	1020lm	113.33lm/W
612822	ILS9T37E27L940NW01	9W	200°	4000K	1030lm	114.44lm/W
612823	ILS9T37E27L950DL01	9W	200°	5000K	1050lm	116.67lm/W
612824	ILS11T45E27L930WW01	11W	200°	3000K	1510lm	137.27lm/W
612825	ILS11T45E27L940NW01	11W	200°	4000K	1520lm	138.18lm/W
612826	ILS11T45E27L950DL01	11W	200°	5000K	1530lm	139.09lm/W





LED Non-Directional Lamp

Twilight

Technical Operating & Electrical Data

Input Voltage & Frequency	AC220-240V, 50/60Hz
Rated CRI	90
Life Span	25,000h
Ingress Protection Rating	IP20
Dimmable or Not	Non Dimmable
Lamp Type	Indirect
Fixed or Adjustable	Fixed

Body Color Options



WH

Areas of Application



Dimensions Options

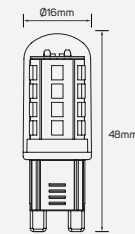

ColorStream

PRODUCT INFORMATION

- LEDspots G9 are designed as a retrofit replacement for halogen spots.
- Deliver significant energy savings and minimize initial investment.
- ILLUS LED G9 lamp gives the customer the flexibility to choose between 2 models based on their specific need with lumen of 210 lm.

BENEFITS

- Up to 90% energy saving compared with traditional halogen lamps.
- Lower maintenance costs.
- Low initial investment.

FEATURES

- High CRI>90.
- Efficacy up to 105lm/w.
- Long life span 25,000 hrs.
- Wide operating voltage AC220 – 240V.
- Non – dimmable.
- UV – and IR – free light.

Family Product List

Code No.	Model No.	CRI	Power	Beam Angle	CCT	Lumen	Efficacy
612446	ILS210G9L927WW01	90	2W	320°	2700K	210lm	105lm/w
612177	ILS210G9L827WW01	80	2.1W	300°	2700K	210lm	100lm/w



LED Filament Lamp

Twilight Wishes

Technical Operating & Electrical Data

Input Voltage & Frequency	AC220-240V, 50/60Hz
Rated CRI	92
Life Span	15,000h
Ingress Protection Rating	IP20
Beam Angle	320°

Areas of Application

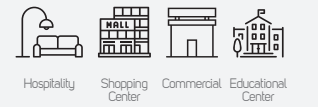

Body Color Options

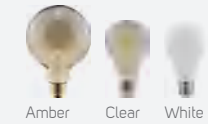

Shape Options



Dimensions Options

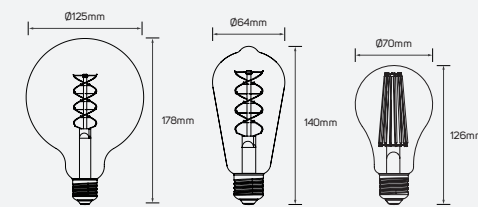

Family Product List

Code No.	Model No.	Power	CCT	Lumen	Efficacy
613431	ILS6.5WDG125E27L918WW01	6.5W	1800K	400lm	61.54lm/W
613429	ILS6.5WDST64E27L918WW01	6.5W	1800K	400lm	61.54lm/W
613397	ILS18A70E27L927WW01	18W	2700K	2500lm	138.89lm/W
613398	ILS18A70E27L927WW02	18W	2700K	2500lm	138.89lm/W

Twilight

PRODUCT INFORMATION

- Combines the familiar shapes of classic incandescent bulbs with long lasting LED technology.
- Delivers beautiful warm white light while saving energy costs compared with traditional light bulbs.
- ILLUS LED FILAMENT E27 Lamp gives the customer the flexibility to choose between 4 models based on their specific need with lumen package from 400 lm to 2500 lm.

BENEFITS

- 90% energy saving.
- Very long lifetime that reduces the need for replacement.
- Easy replacement of classic conventional lamps.

FEATURES

- High CRI>92.
- Efficacy up to 139 lm/w.
- Long life span 15,000 hrs.
- Operating voltage AC220 – 240V.

LED Filament Lamp

Dusk Delight

Technical Operating & Electrical Data

Input Voltage & Frequency	AC220-240V, 50/60Hz
Rated CRI	95
Life Span	15,000h
Ingress Protection Rating	IP20
Dimming	Dimmable

Body Color Options

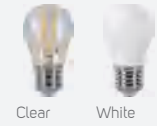

Clear White

Shape Options



Dimensions Options

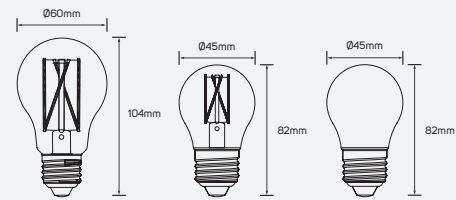

Family Product List

Code No.	Model No.	Power	Beam Angle	CCT	Lumen	Efficacy
614374	ILS4.7DFP45927WW01	4.7W	320°	2700K	480lm	102.13lm/W
614375	ILS7.2DFA60927WW02	7.2W	300°	2700K	800lm	111.11lm/W
614376	ILS9DFA60927WW01	9W	300°	2700K	1080lm	120lm/W
614377	ILS4.7DFP45927WW02	4.7W	320°	2700K	510lm	108.51lm/W

Areas of Application

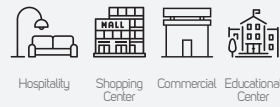



LED Filament E27 Lamp

Neon Nocturne

Technical Operating & Electrical Data

Input Voltage & Frequency	AC220-240V, 50/60Hz
Rated CRI	90
Life Span	15,000h
Ingress Protection Rating	IP20
Dimming	Dimmable
Directional or Non Directional	Non-Directional
Fixed or Adjustable	Fixed

Body Color Options



Shape Options

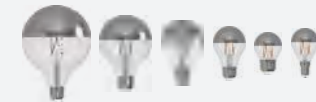

Dimensions Options

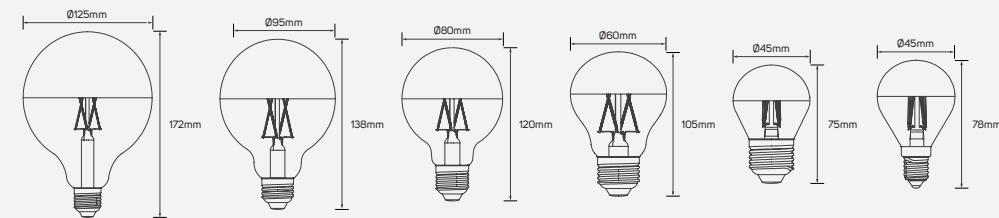

Areas of Application

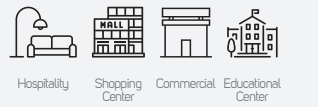

Midnight

PRODUCT INFORMATION

- LEDspots GU10 are designed as a retrofit replacement for halogen spots.
- Deliver significant energy savings and minimize initial investment.
- ILLUS LED GU10 lamp gives the customer the flexibility to choose between 28 models based on their specific need with lumen package from 400 lm to 900 lm.

BENEFITS

- Up to %90 energy saving compared with traditional halogen lamps.
- Lower maintenance costs.
- Low initial investment.

FEATURES

- High CRI>90.
- Efficacy up to 100 lm/w.
- Long life span 25,000h
- Operating voltage AC220 – 240V.
- Non – dimmable.
- UV – IR – free light.

Family Product List

Code No.	Model No.	Power	Beam Angle	CCT	Lumen	Efficacy
612705	ILS4.5WE14DFG45L927WWS01	4.5W	330°	2700K	400lm	89lm/W
612706	ILS4.5WE27DFG45L927WWS01	4.5W	330°	2700K	400lm	89lm/W
612707	ILS7WE27DFA60L927WWS01	7W	330°	2700K	680lm	97lm/W
612708	ILS9WE27DFA60L927WWS01	9W	330°	2700K	900lm	100lm/W
612709	ILS9WE27DFG80L927WWS01	9W	330°	2700K	900lm	100lm/W
612710	ILS9WE27DFG95L927WWS01	9W	330°	2700K	900lm	100lm/W
612711	ILS9WE27DFG125L927WWS01	9W	330°	2700K	900lm	100lm/W
612712	ILS4.5WE14DFG45L927WWG01	4.5W	330°	2700K	400lm	89lm/W
612713	ILS4.5WE27DFG45L927WWG01	4.5W	330°	2700K	400lm	89lm/W
612714	ILS7WE27DFA60L927WWG01	7W	330°	2700K	680lm	97lm/W
612715	ILS9WE27DFA60L927WWG01	9W	330°	2700K	900lm	100lm/W
612716	ILS9WE27DFG80L927WWG01	9W	330°	2700K	900lm	100lm/W
612717	ILS9WE27DFG95L927WWG01	9W	330°	2700K	900lm	100m/W
612718	ILS9WE27DFG125L927WWG01	9W	330°	2700K	900lm	100lm/W

Family Product List

Code No.	Model No.	Power	Beam Angle	CCT	Lumen	Efficacy
● 612719	ILS4.5WE14DFG45L927WWRG01	4.5W	330°	2700K	400lm	89lm/W
● 612720	ILS4.5WE27DFG45L927WWRG01	4.5W	330°	2700K	400lm	89lm/W
● 612721	ILS7WE27DFA60L927WWRG01	7W	330°	2700K	680lm	97lm/W
● 612722	ILS9WE27DFA60L927WWRG01	9W	330°	2700K	900lm	100lm/W
● 612723	ILS9WE27DFG80L927WWRG01	9W	330°	2700K	900lm	100lm/W
● 612724	ILS9WE27DFG95L927WWRG01	9W	330°	2700K	900lm	100lm/W
● 612725	ILS9WE27DFG125L927WWRG01	9W	330°	2700K	900lm	100lm/W
● 612726	ILS4.5WE14DFG45L927WWB01	4.5W	330°	2700K	400lm	89lm/W
● 612727	ILS4.5WE27DFG45L927WWB01	4.5W	330°	2700K	400lm	89lm/W
● 612728	ILS7WE27DFA60L927WWB01	7W	330°	2700K	680lm	97lm/W
● 612729	ILS9WE27DFA60L927WWB01	9W	330°	2700K	900lm	100lm/W
● 612730	ILS9WE27DFG80L927WWB01	9W	330°	2700K	900lm	100lm/W
● 612731	ILS9WE27DFG95L927WWB01	9W	330°	2700K	900lm	100lm/W
● 612732	ILS9WE27DFG125L927WWB01	9W	330°	2700K	900lm	100lm/W





LED Filament E27 Lamp

Midnight Aurora

Technical Operating & Electrical Data

Input Voltage & Frequency	AC220-240V, 50/60Hz
Rated CRI	90
Life Span	15,000h
Ingress Protection Rating	IP20
Dimmable or Not	Dimmable
Directional or Non Directional	Directional
Fixed or Adjustable	Fixed

Body Color Options



Glass

Shape Options



Dimensions Options

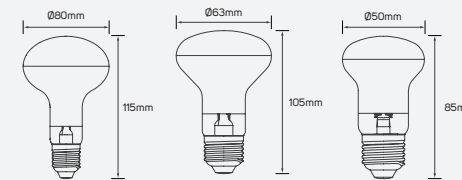

Areas of Application



Midnight

PRODUCT INFORMATION

- Combines the familiar shapes of classic incandescent bulbs with long lasting LED technology.
- Delivers beautiful warm white light while saving energy costs compared with traditional light bulbs.
- ILLUS LED NON – DIRECTIONAL Lamp gives the customer the flexibility to choose between 3 models based on their specific need with lumen package from 330 lm to 560 lm.

BENEFITS

- Very long lifetime that reduces the need for replacement.
- Easy replacement of classic conventional lamps.

FEATURES

- High CRI>90.
- Efficacy up to 80 lm/w.
- Long life span 15,000 hrs.
- Operating voltage AC220 – 240V.
- Dimmable.

Family Product List

Code No.	Model No.	Power	Beam Angle	CCT	Lumen	Efficacy
612734	ILS4.5WE27DFR50L927WW01	4.5W	60°	2700K	330lm	73lm/W
612735	ILS7WE27DFR63L927WW01	7W	60°	2700K	560lm	80lm/W
612736	ILS7WE27DFR80L927WW01	7W	60°	2700K	560lm	80lm/W



LED Filament E27 Lamp

Starlit Tango

Technical Operating & Electrical Data

Input Voltage & Frequency	AC220-240V, 50/60Hz
Rated CRI	95
Life Span	15,000h
Ingress Protection Rating	IP20
Beam Angle	320°

Areas of Application



Body Color Options



Clear

Shape Options



Dimensions Options

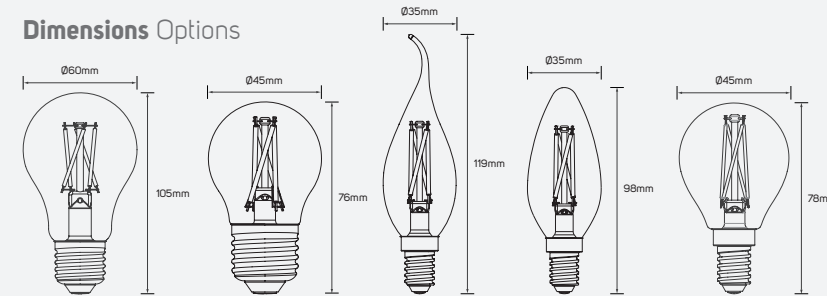

Family Product List

Code No.	Model No.	Power	CCT	Lumen	Efficacy
○ 611712	ILS370FA927WW01	4W	2700K	370lm	92lm/w
○ 611713	ILS650FA927WW01	6.5W	2700K	650lm	100lm/w
○ 611714	ILS820FA927WW01	7.9W	2700K	820lm	104lm/w
○ 611715	ILS360FC927WW01	3.9W	2700K	360lm	92lm/w
○ 611716	ILS360FCT927WW01	3.9W	2700K	360lm	92lm/w
○ 611717	ILS360FP45L927WW01	3.9W	2700K	360lm	92lm/w
○ 612562	ILS400DFA927WW01	5W	2700K	400lm	80lm/w
○ 612563	ILS650DFA927WW01	7.2W	2700K	650lm	90.3lm/w
○ 612564	ILS850DFA927WW01	9.2W	2700K	850lm	92.4lm/w
○ 612565	ILS400DFC927WW01	4.8W	2700K	400lm	83.3lm/w
○ 612566	ILS400DFCT927WW01	4.8W	2700K	400lm	83.3lm/w
○ 612567	ILS400DFP45L927WW01	5W	2700K	400lm	80lm/w
○ 612591	ILS400DFG45L927WW01	5W	2700K	400lm	80lm/w

LED Lamp

PRODUCT INFORMATION

- Combines the familiar shapes of classic incandescent bulbs with long lasting LED technology.
- Delivers beautiful warm white light while saving energy costs compared with traditional light bulbs.
- ILLUS LED NON – DIRECTIONAL Lamp gives the customer the flexibility to choose between 13 models based on their specific need with lumen package from 360 lm to 850 lm.

BENEFITS

- 90% energy saving.
- Very long lifetime that reduces the need for replacement.
- Easy replacement of classic conventional lamps.

FEATURES

- High CRI>95.
- Efficacy up to 104 lm/w.
- Long life span 15,000 hrs.
- Wide operating voltage AC220 – 240V.
- Non-Dimmable.

Starlit Tango

Technical Operating & Electrical Data

Input Voltage & Frequency	AC220-240V, 50/60Hz
Rated CRI	95
Life Span	15,000h
Ingress Protection Rating	IP20
Dimming	Dimming

Body Color Options



WH

Shape Options



Dimensions Options

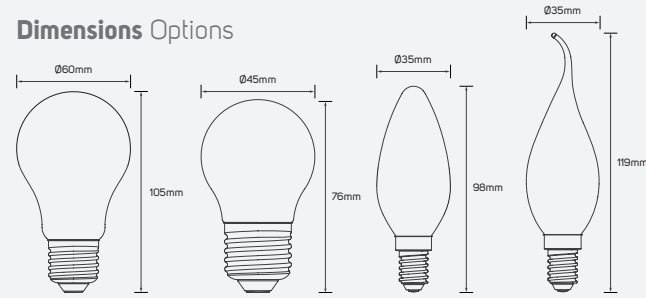

Family Product List

Code No.	Model No.	Power	Beam Angle	CCT	Lumen	Efficacy
612572	ILS350DMFA927WW01	5W	320°	2700K	350lm	70lm/w
612573	ILS550DMFA927WW01	7.2W	320°	2700K	500lm	69.4lm/w
612574	ILS750DMFA927WW01	9.2W	320°	2700K	730lm	79lm/w
612575	ILS350DMFC927WW01	4.8W	320°	2700K	350lm	72.9lm/w
612576	ILS350DMFCT927WW01	4.8W	320°	2700K	350lm	72.9lm/w
612577	ILS350DMFP45L927WW01	5W	320°	2700K	350lm	70lm/w

Areas of Application

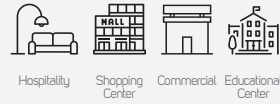

Starlit Tango

Technical Operating & Electrical Data

Input Voltage & Frequency	AC220-240V, 50/60Hz
Rated CRI	95
Life Span	15,000h
Ingress Protection Rating	IP20
Beam Angle	320°

Body Color Options



Shape Options



Dimensions Options

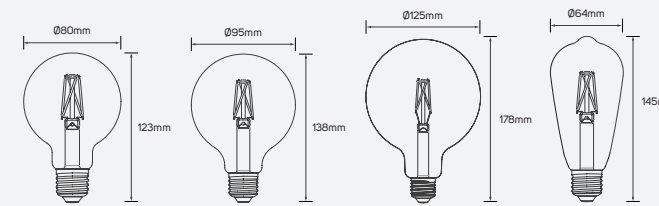

Family Product List

Code No.	Model No.	Power	CCT	Lumen	Efficacy
611718	ILS280GFG80L920WW01	4W	2000K	280lm	70lm/w
611719	ILS280GFG95L920WW01	4W	2000K	280lm	70lm/w
611720	ILS280GFG125L920WW01	4W	2000K	280lm	70lm/w
611721	ILS280GFST64L920WW01	4W	2000K	280lm	70lm/w
612568	ILS330GFST64L920WW01	4.5W	2000K	330lm	73.3lm/w
612569	IL330GFG80L920WW01	4.5W	2000K	330lm	73.3lm/w
612570	ILS330GFG95L920WW01	4.5W	2000K	330lm	73.3lm/w
612571	ILS330GFG125L920WW01	4.5W	2000K	330lm	73.3lm/w

Areas of Application

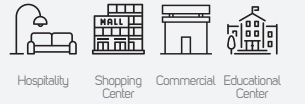

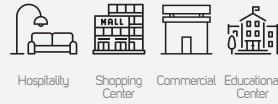

Starlit Tango

Technical Operating & Electrical Data

Input Voltage & Frequency	AC220-240V, 50/60Hz
Rated CRI	95
Life Span	15,000h
Ingress Protection Rating	IP20
Dimming	Dimming



Body Color Options



Shape Options



Dimensions Options

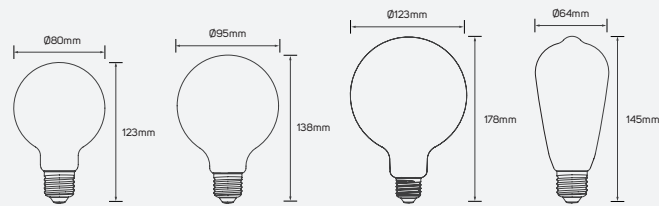

Family Product List

Code No.	Model No.	Power	Beam Angle	CCT	Lumen	Efficacy
612578	ILS350DMFST64L927WW01	4.8W	320°	2700K	350lm	72.9lm/w
612579	ILS350DMFG80L927WW01	4.8W	320°	2700K	350lm	72.9lm/w
612580	ILS350DMFG95L927WW01	4.8W	320°	2700K	350lm	72.9lm/w
612581	ILS350DMFG125L927WW01	4.8W	320°	2700K	350lm	72.9lm/w





GX53

Pure Radiance

Technical Operating & Electrical Data

Input Voltage & Frequency	AC220-240V, 50/60Hz
Body Material	Plastic
Life Span	25,000h
Ingress Protection Rating	IP20
Dimming	Non-Dimmable
Beam Angle	110°
CRI	92
Cap Type	GX53

Areas of Application



Body Color Options



White

Dimensions Options

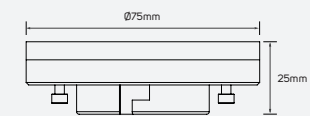

GX53

PRODUCT INFORMATION

- Combines the familiar shapes of classic incandescent bulbs with long lasting LED technology.
- Delivers beautiful warm white light while saving energy costs compared with traditional light bulbs.
- ILLUS LED GX53 Lamp gives the customer the flexibility to choose between 3 models based on their specific need with lumen package from 570 lm to 840 lm.

BENEFITS

- 90% energy saving.
- Very long lifetime that reduces the need for replacement.
- Easy replacement of classic conventional lamps.

FEATURES

- High CRI>92.
- Efficacy up to 120 lm/w.
- Long life span 15,000 hrs.
- Operating voltage AC100-240V.

Family Product List

Code No.	Model No.	Power	CCT	Lumen	Efficacy
613402	ILS4.9GX53L940NW01	4.9W	4000K	570lm	116.33lm/W
613409	ILS7GX53L930WW01	7W	3000K	830lm	118.57lm/W
613410	ILS7GX53L940NW01	7W	4000K	840lm	120lm/W



LED AR111

Refined Brilliance

Technical Operating & Electrical Data

Input Voltage & Frequency	AC220-240V, 50/60Hz
Cap Type	AR111
Life Span	40,000h
Ingress Protection Rating	IP20
Dimming	Dimmable
Beam Angle	34°
Body Material	Aluminum+PC Reflector
Mounting Type	Mounted on Ceiling with Frames

Areas of Application

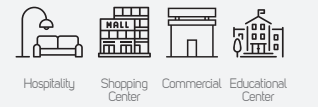

Reflector Color Options



Lens Options

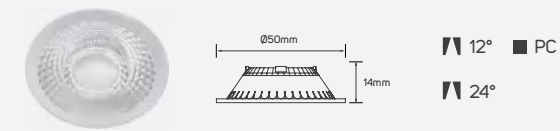

Dimensions Options

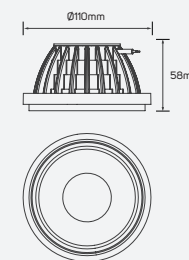

LED AR111

White Black/White

PRODUCT INFORMATION

- LED AR111 creates a brilliant visual effect.
- Colors stay vibrant and natural enhancing the appeal of everything on display.
- ILLUS LED AR111 module gives the customer the flexibility to choose between 10 models based on their specific need with lumen package from 770 lm to 1350 lm.

BENEFITS

- High intensity of beam for accent lighting with strong lumen maintenance.
- More vivid, vibrant colors over time for merchandise display with no harmful UV.
- Innovative design with hassle free retrofit solution.

FEATURES

- High CRI>95.
- Long life span 40,000 hrs.
- Wide operating voltage AC220 – 240V.
- Dimmable.

Family Product List

Code No.	Model No.	Power	CCT	Lumen	Efficacy
5101515	ILS10D111M927WW01	10W	2700K	770lm	77lm/w
5101516	ILS10D111M930WW01	10W	3000K	790lm	79lm/w
5101517	ILS10D111M935WW01	10W	3500K	840lm	84lm/w
5101518	ILS10D111M940NW01	10W	4000K	880lm	88lm/w
5101519	ILS10D111M950DL01	10W	5000K	910lm	91lm/w
5101520	ILS15D111M927WW01	15W	2700K	1115lm	74.33lm/w
5101521	ILS15D111M930WW01	15W	3000K	1150lm	76.67lm/w
5101522	ILS15D111M935WW01	15W	3500K	1200lm	80lm/w
5101523	ILS15D111M940NW01	15W	4000K	1250lm	83.33lm/w
5101524	ILS15D111M950DL01	15W	5000K	1350lm	90lm/w

Lens Options

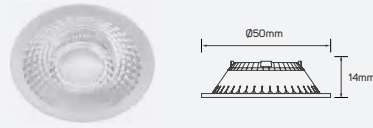

Code No.	Model No.	Beam Angle	Body Color	Material
5101525	ILS111M12L01	12°	transparent	PC
5101526	ILS111M24L01	24°	transparent	PC

Reflector Color Options



Code No.	Model No.	Body Color	Material	Type of Frame
5101697	ILS082FRMAR111W01	matt white	PC	fixed
5101698	ILS082FRMAR111S01	silver	PC	fixed
5101699	ILS082FRMAR111AS01	anti-glare silver	PC	fixed
5101700	ILS082FRMAR111AB01	anti-glare black	PC	fixed
5101701	ILS082FRMAR111B01	matt black	PC	fixed
5101702	ILS082FRMAR111ACG01	anti-glare chrome gold	PC	fixed
5101703	ILS082FRMAR111RG01	anti-glare rose gold	PC	fixed

LED AR111

Refined Brilliance

Technical Operating & Electrical Data

Input Voltage & Frequency	AC220-240V, 50/60Hz
Cap Type	AR111
Life Span	40,000h
Ingress Protection Rating	IP20
Dimming	Non- Dimmable
Beam Angle	34°
Body Material	Aluminum+PC Reflector
Mounting Type	Mounted on Ceiling with Frames
CRI	95

Areas of Application

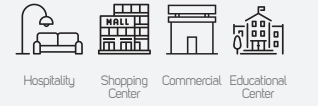

Reflector Color Options



Grey

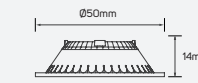

45° ■ PC

Dimensions Options

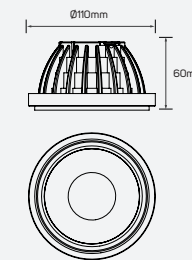

Family Product List

Code No.	Model No.	Power	CCT	Lumen	Efficacy
5101768	ILS20AR111L930WW01	20W	3000K	1600lm	80lm/w
5101769	ILS20AR111L940NW01	20W	4000K	1750lm	87.5lm/w
5101770	ILS20AR111L950DL01	20W	5000K	2050lm	102.5lm/w
5101771	ILS25AR111L930WW01	25W	3000K	1950lm	78lm/w
5101772	ILS25AR111L940NW01	25W	4000K	2150lm	86lm/w
5101773	ILS25AR111L950DL01	25W	5000K	2450lm	98lm/w

Lens Options

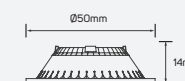

Code No.	Model No.	Beam Angle	Body Color	Material
5101774	ILS45LENSAR111L01	45°	Clear	PC

LED AR111

Refined Brilliance

Technical Operating & Electrical Data

Input Voltage & Frequency	AC220-240V, 50/60Hz
Cap Type	AR111
Life Span	25,000h
Ingress Protection Rating	IP20
Dimming	Dimmable
Beam Angle	30°
Body Material	Aluminum+PC Reflector
Mounting Type	Mounted on Ceiling with Frames
CRI	95

Areas of Application

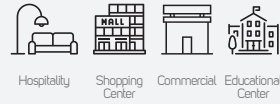

Reflector Color Options



Grey

Dimensions Options

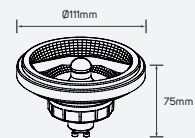

Family Product List

Code No.	Model No.	Power	CCT	Lumen	Efficacy
612451	ILS520AR111L927WW01	10W	2700K	520lm	52lm/w
612452	ILS540AR111L930WW01	10W	3000K	540lm	54lm/w
612453	ILS560AR111L940NW01	10W	4000K	560lm	56lm/w
612454	ILS570AR111L950DL01	10W	5000K	570lm	57lm/w
612455	ILS700AR111L927WW01	14W	2700K	700lm	50lm/w
612456	ILS710AR111L930WW01	14W	3000K	710lm	50lm/w
612457	ILS730AR111L940NW01	14W	4000K	730lm	52lm/w
612458	ILS740AR111L950DL01	14W	5000K	740lm	52lm/w





LED 50 Module (GU10)

Vision

Technical Operating & Electrical Data

Input Voltage & Frequency	AC220-240V, 50/60Hz
Body Material	Aluminum
Life Span	30,000h
IP Ratings	IP65
Dimming	Non-Dimmable
Beam Angle	24°

Areas of Application

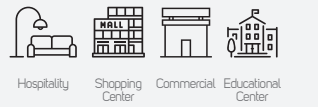

Body Color Options



Grey

Lens Options

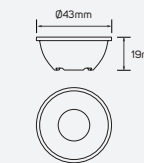

- ▲ 15° ■ PC
- ▲ 24°
- ▲ 36°

Dimensions Options

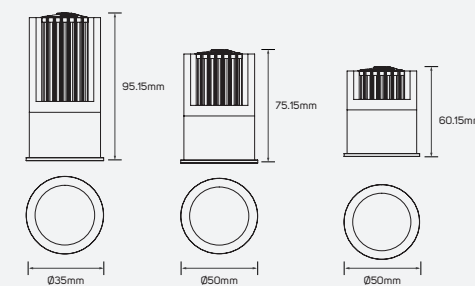

Shape Options



Honeycomb Options

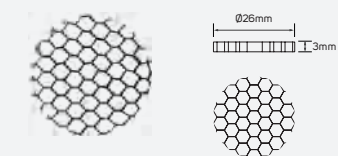

ArtisticVista

PRODUCT INFORMATION

- Suitable for a series of lighting applications in office, retail and general area lighting.
- Available in a wide variety of lumen packs, cut out size and color temperature.
- ILLUS LED MODULE Luminaire (MR11) gives the customer the flexibility to choose between 12 models based on their specific need with lumen package from 420 lm to 1200 lm.

BENEFITS

- Compact design for better integration with the building.
- Comfortable light with high efficiency.
- Reliable performance for indoor applications.

FEATURES

- High CRI>95.
- Efficacy up to 95lm/w.
- Long life span 30,000hrs.
- Operating voltage AC220-240V .
- Non - dimmable.

Family Product List

Code No.	Model No.	Power	CCT	Lumen	Efficacy
614083	ILS5.3MR16M927WW01	5.3W	2700K	420lm	79.25lm/W
614084	ILS5.3MR16M930WW01	5.3W	3000K	440lm	83.02lm/W
614085	ILS5.3MR16M940NW01	5.3W	4000K	460lm	86.79lm/W
614086	ILS5.3MR16M950DL01	5.3W	5000K	480lm	90.57lm/W
614088	ILS10MR16M927WW01	10W	2700K	800lm	80lm/W
614089	ILS10MR16M930WW01	10W	3000K	850lm	85lm/W
614090	ILS10MR16M940NW01	10W	4000K	900lm	90lm/W
614091	ILS10MR16M950DL01	10W	5000K	950lm	95lm/W
614093	ILS13MR16M927WW01	13W	2700K	1000lm	76.92lm/W
614094	ILS13MR16M930WW01	13W	3000K	1050lm	80.77lm/W
614095	ILS13MR16M940NW01	13W	4000K	1110lm	85.38lm/W
614096	ILS13MR16M950DL01	13W	5000K	1200lm	92.31lm/W

Driver Specifications

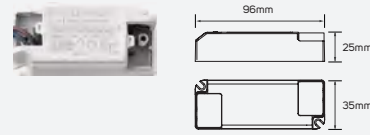

Code No.	Model No.	Power	Body Color	Body Material
614087	ILSACD6WMLD01	6W	white	PVC+copper
614092	ILSACD10WMLD01	10.5W	white	PVC+copper
614097	ILSACD15WMLD01	15W	white	PVC+copper

Lens Specifications

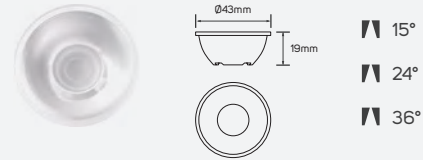

Code No.	Model No.	Beam Angle	Body Color	Body Material
614098	ILS15DGMR16LEN01	15°	transparent	PC
614099	ILS24DGMR16LEN01	24°	transparent	PC
614100	ILS36DGMR16LEN01	36°	transparent	PC

Honeycomb Specifications

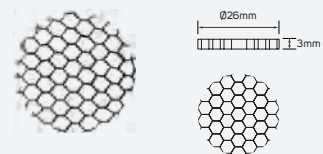

Code No.	Model No.	Body Color	Body Material
614101	ILSMR16HC01	black	PC

LED 50 Module (GU10)

Radiant Light

Technical Operating & Electrical Data

Input Voltage & Frequency	AC220-240V, 50/60Hz
Body Material	Aluminum
Life Span	25,000h
IP Ratings	IP20
Dimming	Non-Dimmable
Beam Angle	36°
Cap Type	GU10

Areas of Application



Body Color Options



Black

Lens Options

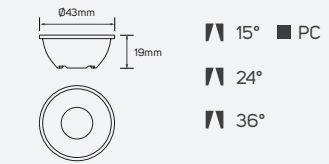

Dimensions Options

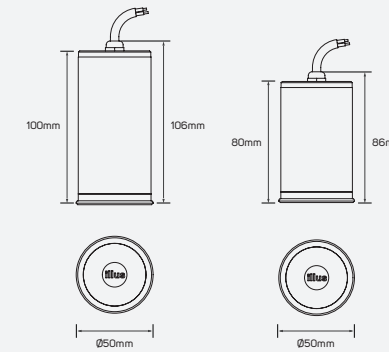

Shape Options



Honeycomb Options

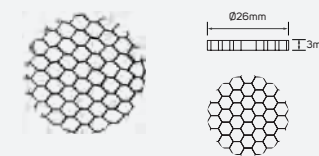

Agile

Technical Operating & Electrical Data

Input Voltage & Frequency	AC220-240V, 50/60Hz
Body Material	Aluminum
Life Span	50,000h
IP Ratings	IP20
Dimming	Non-Dimmable
Beam Angle	24°
CRI	95



Areas of Application

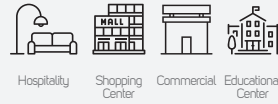

Shape&Body Options



Grey

Lens Options

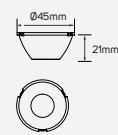

- ▲ 15° ■ PC
- ▲ 36°
- ▲ 50°

Dimensions Options

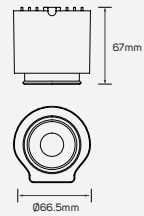

Family Product List

Code No.	Model No.	Lumen	Efficacy	CCT	Lamp Type
● 5101775	ILS19GU10M927WW01	1450lm	76.32lm/w	2700K	Direct
● 5101776	ILS19GU10M930WW01	1500lm	78.95lm/w	3000K	Direct
● 5101777	ILS19GU10M940NW01	1700lm	89.47lm/w	4000K	Direct
● 5101778	ILS19GU10M950DL01	1800lm	94.74lm/w	5000K	Direct

Lens Specifications

Code No.	Model No.	Beam Angle	Body Color	Body Material
○ 5101779	ILS15LENSGU10M01	15°	Clear	PC
○ 5101780	ILS36LENSGU10M01	36°	Clear	PC
○ 5101781	ILS45LENSGU10M01	50°	Clear	PC





LED 35 Module (MR11)

Wisdom

Technical Operating & Electrical Data

Input Voltage & Frequency	AC220-240V, 50/60Hz
Body Material	Aluminum
Life Span	30,000h
Ingress Protection Rating	IP65
Dimming	Non-Dimmable
Beam Angle	30°

Areas of Application



Body Color Options



Grey

Lens Options

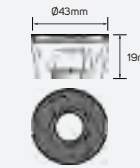

▲ 15° ■ PC
▲ 24°

Dimensions Options

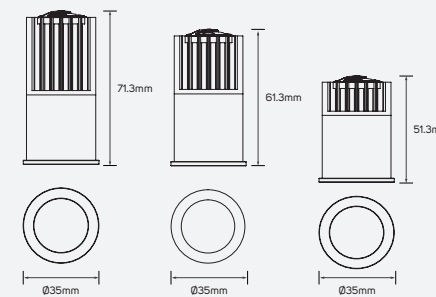

Shape Options



Honeycomb Options

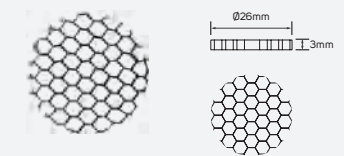

Wisdom

PRODUCT INFORMATION

- Suitable for a series of lighting applications in office, retail and general area lighting.
- Available in a wide variety of lumen packs, cut out size and color temperature.
- ILLUS LED MODULE Luminaire (MR11) gives the customer the flexibility to choose between 12 models based on their specific need with lumen package from 300 lm to 580 lm.

BENEFITS

- Compact design for better integration with the building.
- Comfortable light with high efficiency.
- Reliable performance for indoor applications.

FEATURES

- High CRI>95.
- Efficacy up to 79lm/w.
- Long life span 30,000hrs.
- Operating voltage AC220-240V .
- Non - dimmable.

Family Product List

Code No.	Model No.	Power	CCT	Lumen	Efficacy
614102	ILS4.2MR11M927WW01	4.2W	2700K	300lm	71.43lm/W
614103	ILS4.2MR11M930WW01	4.2W	3000K	305lm	72.62lm/W
614104	ILS4.2MR11M940NW01	4.2W	4000K	315lm	75lm/W
614105	ILS4.2MR11M950DL01	4.2W	5000K	325lm	77.38lm/W
614107	ILS5.3MR11M927WW01	5.3W	2700K	380lm	71.7lm/W
614108	ILS5.3MR11M930WW01	5.3W	3000K	400lm	75.47lm/W
614109	ILS5.3MR11M940NW01	5.3W	4000K	420lm	79.25lm/W
614110	ILS5.3MR11M950DL01	5.3W	5000K	445lm	59.33lm/W
614111	ILS7.5MR11M927WW01	7.5W	2700K	490lm	65.33lm/W
614112	ILS7.5MR11M930WW01	7.5W	3000K	520lm	69.33lm/W
614113	ILS7.5MR11M940NW01	7.5W	4000K	550lm	73.33lm/W
614114	ILS7.5MR11M950DL01	7.5W	5000K	580lm	77.33lm/W

Driver Specifications

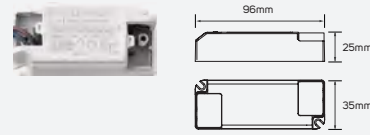

Code No.	Model No.	Power	Body Color	Body Material
614106	ILSACD4WMLD01	5.3W	white	PVC+copper
614118	ILSACD8WMLD01	6W	white	PVC+copper

Lens Specifications

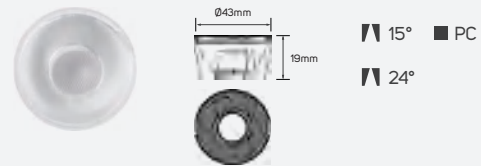

Code No.	Model No.	Beam Angle	Body Color	Body Material
614115	ILS12DGMR11LEN01	12°	white	PC
614116	ILS24DGMR11LEN01	24°	white	PC

Honeycomb Specifications

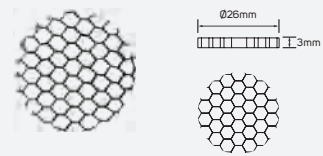

Code No.	Model No.	Body Color	Body Material
614117	ILSMR11HC01	black	PC

Beyond Light,
To the last details



LED Filament Lamp (PIR Sensor)

Velvet Visions

Technical Operating & Electrical Data

Input Voltage & Frequency	AC220-240V, 50/60Hz
Rated CRI	80
Life Span	15,000h
Ingress Protection Rating	IP20
Dimming	Non- Dimmable
Directional or Non Directional	Non-Directional

Body Color Options



White

Dimensions Options

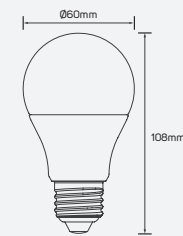

Areas of Application



Twinkle

PRODUCT INFORMATION

- A clever energy efficient addition to any home.
- Thanks to a built-in sensor, this modern LED lamp can detect when you walk close by and turn on automatically.
- ILLUS MICROWAVE LED E27 Lamp gives the customer the flexibility to choose between 9 models based on their specific need with lumen package from 570 lm to 1210 lm.

BENEFITS

- Equipped with a daylight sensor that turns your light bulb on automatically in darkness.
- Very long lifetime that reduces the need for replacement.
- Easy replacement of classic conventional lamps.

FEATURES

- High CRI>80.
- Efficacy up to 125 lm/w.
- Long life span 15,000 hrs.
- Operating voltage AC220 – 240V.
- Non – dimmable.

Family Product List

Code No.	Model No.	Power	Beam Angle	CCT	Lumen	Efficacy
614120	ILS4.8A60MCOE27FL830WW01	4.8W	200°	3000K	570lm	119lm/W
614121	ILS4.8A60MCOE27FL840NW01	4.8W	200°	4000K	580lm	121lm/W
614122	ILS4.8A60MCOE27FL850DL01	4.8W	200°	5000K	600lm	125lm/W
614123	ILS8.5A60MCOE27FL830WW01	8.5W	240°	3000K	880lm	104lm/W
614124	ILS8.5A60MCOE27FL840NW01	8.5W	240°	4000K	900lm	106lm/W
614125	ILS8.5A60MCOE27FL850DL01	8.5W	240°	5000K	950lm	112lm/W
614126	ILS10A60MCOE27FL830WW01	10W	240°	3000K	1150lm	115lm/W
614127	ILS10A60MCOE27FL840NW01	10W	240°	4000K	1170lm	117lm/W
614128	ILS10A60MCOE27FL850DL01	10W	240°	5000K	1210lm	121lm/W

LED Filament Lamp (Microwave Sensor)

EtherealTwinkle

Technical Operating & Electrical Data

Input Voltage & Frequency	AC220-240V, 50/60Hz
Rated CRI	80
Life Span	15,000h
Ingress Protection Rating	IP20
Dimming	Non- Dimmable
Directional or Non Directional	Non-Directional

Body Color Options



Clear

Dimensions Options

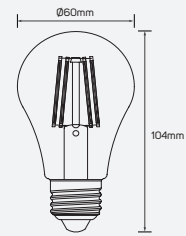

Family Product List

Code No.	Model No.	Power	Beam Angle	CCT	Lumen	Efficacy
○ 614129	ILS7.5A60SOSE27FL830WW01	7.5W	320°	3000K	1120lm	149lm/W
○ 614130	ILS7.5A60SOSE27FL840NW01	7.5W	320°	4000K	1140lm	152lm/W
○ 614131	ILS7.5A60SOSE27FL850DL01	7.5W	320°	5000K	1170lm	156lm/W
○ 614132	ILS6.5A60SOSE27FL830WW01	6.5W	320°	3000K	960lm	148lm/W
○ 614133	ILS6.5A60SOSE27FL840NW01	6.5W	320°	4000K	970lm	149lm/W
○ 614134	ILS6.5A60SOSE27FL850DL01	6.5W	320°	5000K	990lm	152lm/W

Areas of Application

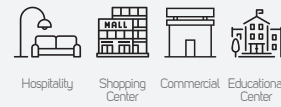



LED T8 Glass Tube Light

ModernGlow

Technical Operating & Electrical Data

Input Voltage & Frequency	AC220-240V, 50/60Hz
Rated CRI	80
Life Span	15,000h
Ingress Protection Rating	IP20
Body Material	Plastic

Areas of Application

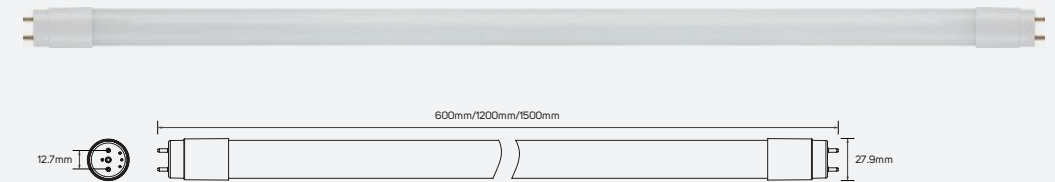
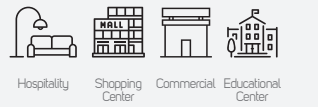

Family Product List

Code No.	Power	CCT	Lumen	Code No.	Power	CCT	Lumen
612481	9W	3000K	900lm	612487	24W	3000K	2260lm
612482	9W	4000K	930lm	612488	24W	4000K	2290lm
612483	9W	6500K	940lm	612489	24W	6500K	2330lm
612484	18W	3000K	1820lm				
612485	18W	4000K	1840lm				
612486	18W	6500K	1870lm				

Areas of Application

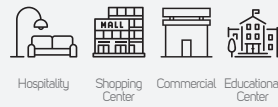

ModernGlow

Technical Operating & Electrical Data

Input Voltage & Frequency	AC220-240V, 50/60Hz
Rated CRI	92
Life Span	30,000h
Ingress Protection Rating	IP20
Body Material	Aluminum+Plastic
Beam Angle	160°

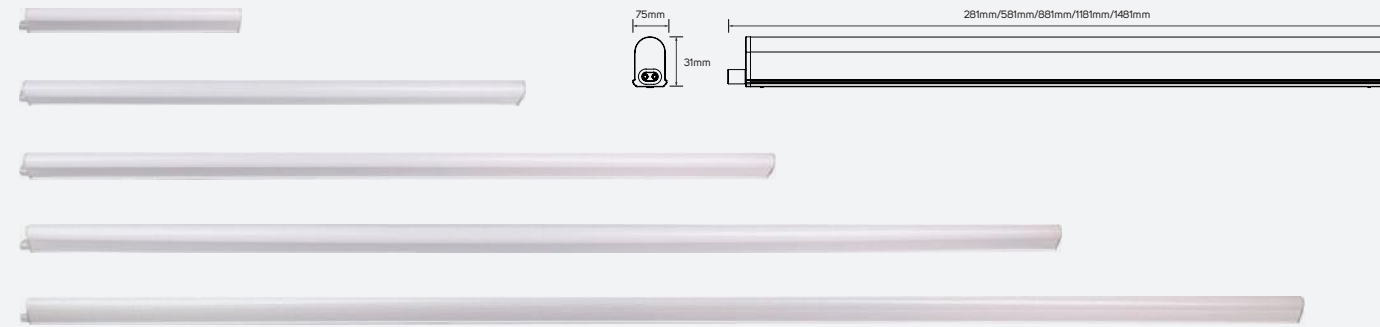

Family Product List

Code No.	Power	CCT	Lumen	Code No.	Power	CCT	Lumen
612425	5W	2700K	490lm	612437	18.5W	2700K	1730lm
612426	5W	3000K	505lm	612438	18.5W	3000K	1760lm
612427	5W	4000K	530lm	612439	18.5W	4000K	1840lm
612428	5W	5000K	540lm	612440	18.5W	5000K	1860lm
612429	9W	2700K	880lm	612441	24W	2700K	2180lm
612430	9W	3000K	890lm	612442	24W	3000K	2250lm
612431	9W	4000K	940lm	612443	24W	4000K	2400lm
612432	9W	5000K	970lm	612444	24W	5000K	2420lm
612433	14.5W	2700K	1370lm				
612434	14.5W	3000K	1380lm				
612435	14.5W	4000K	1450lm				
612436	14.5W	5000K	1460lm				



Accessories

■ Indoor Connector

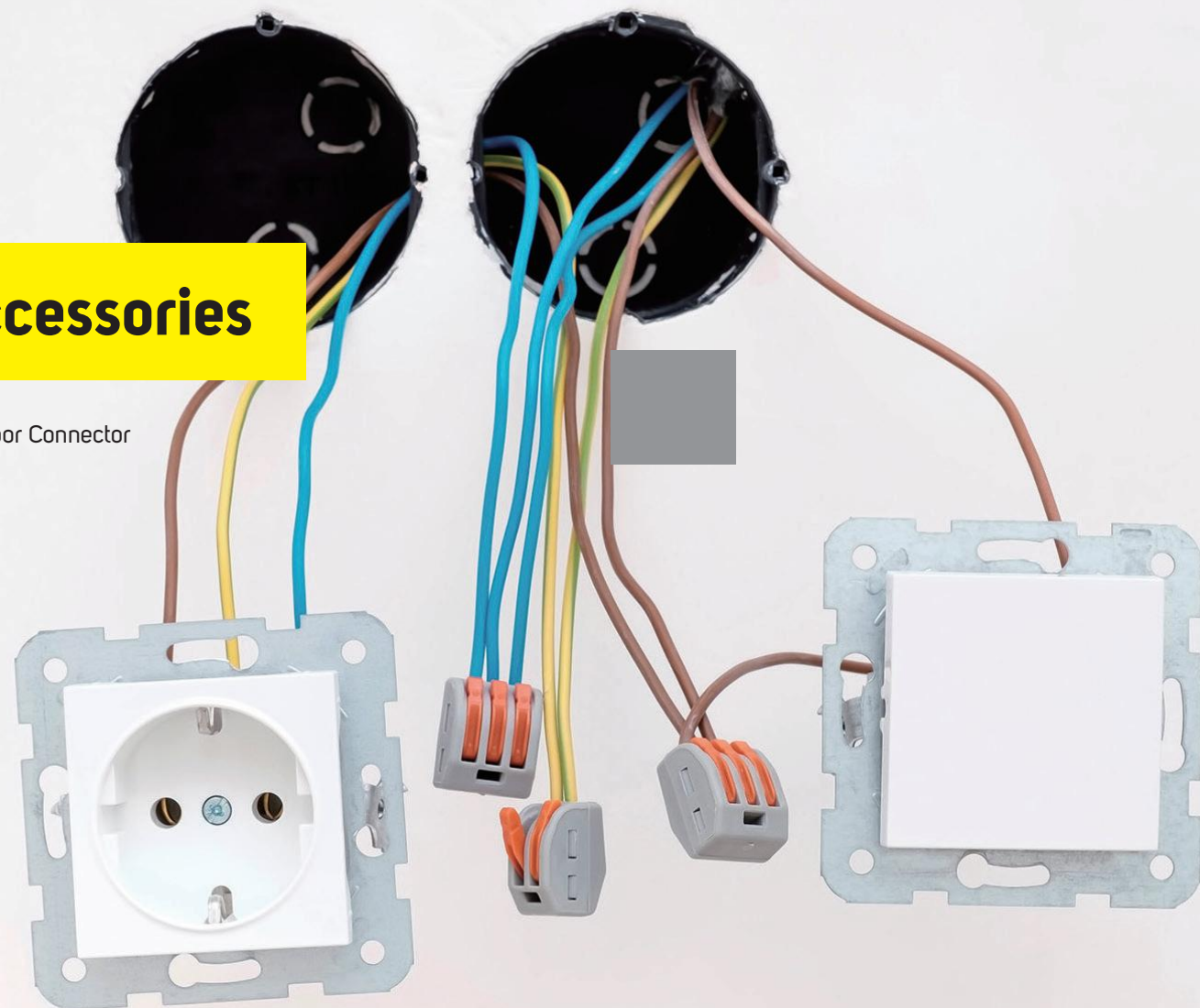

Indoor Connector

Power

Technical Operating & Electrical Data

Input Voltage & Frequency AC220-240V, 50/60Hz
 Body Color White

Areas of Application

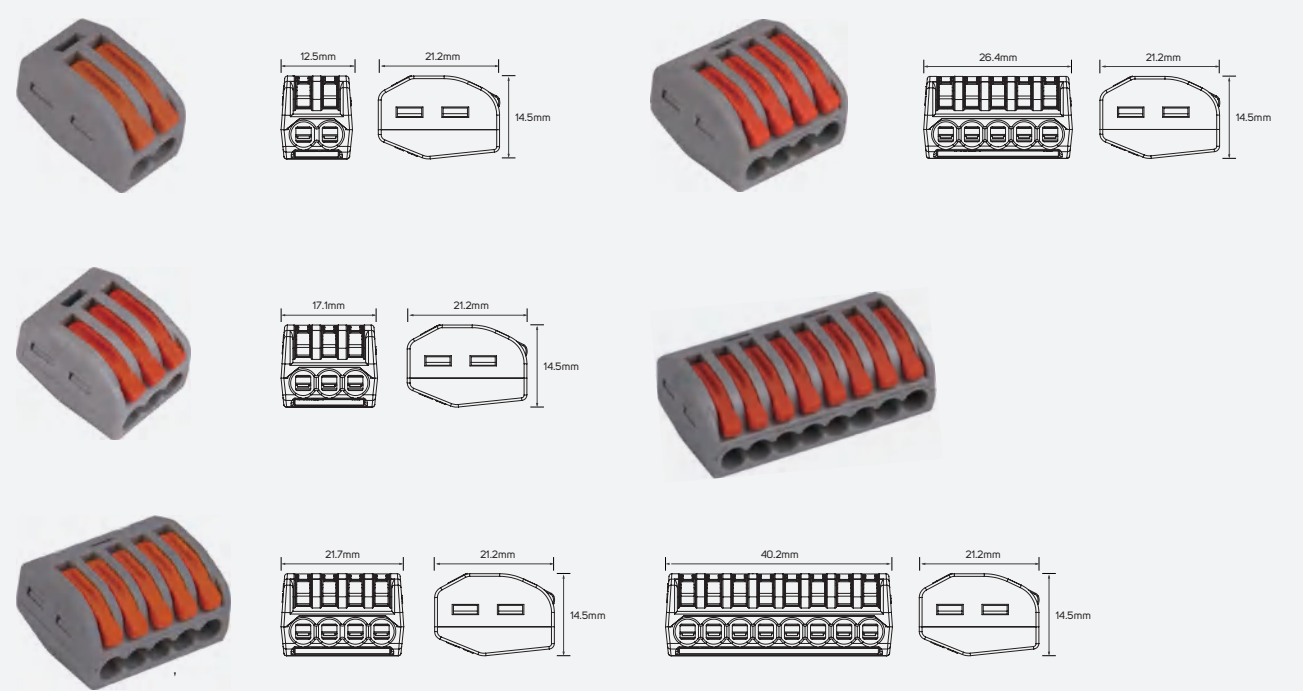
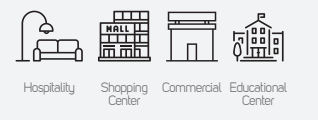

- 613174
- 613175
- 613176

- 613177
- 613178

■ Nylon
 □ AC100-240V

Indoor Connector

Power

Technical Operating & Electrical Data

Input Voltage & Frequency AC220-240V, 50/60Hz
 Body Color White

Areas of Application

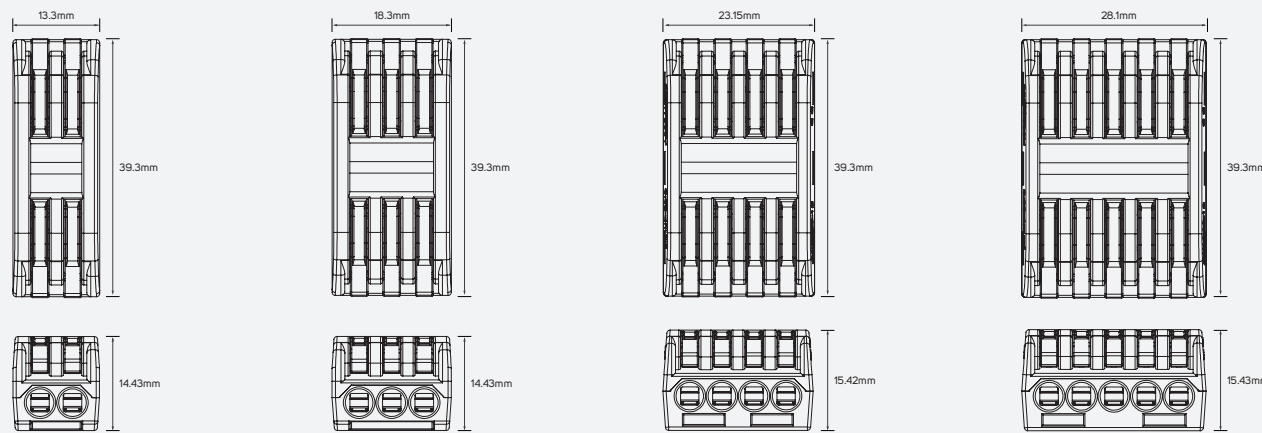
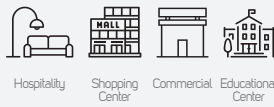

- 613179 613181
- 613180 613182

■ Nylon
 □ AC100-240V

Indoor Connector

Power

Technical Operating & Electrical Data

Input Voltage & Frequency AC220-240V, 50/60Hz
 Body Color White

Areas of Application

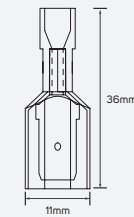
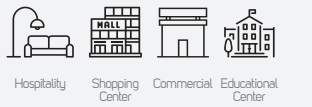

- 613168
- 613169
- 613170

■ Nylon+Copper
 □ AC100-240V

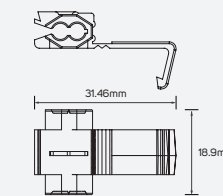
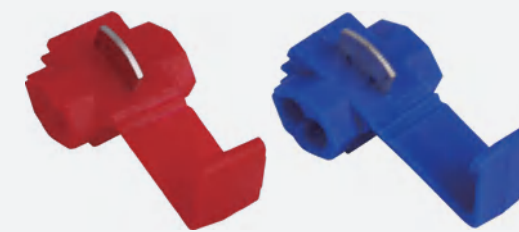

- 613171
- 613172

613173

■ Nylon+Copper
 □ AC100-240V

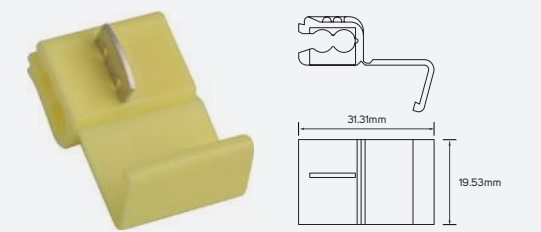

Indoor Connector

Power

Technical Operating & Electrical Data

Input Voltage & Frequency AC220-240V, 50/60Hz
 Body Color White

Areas of Application

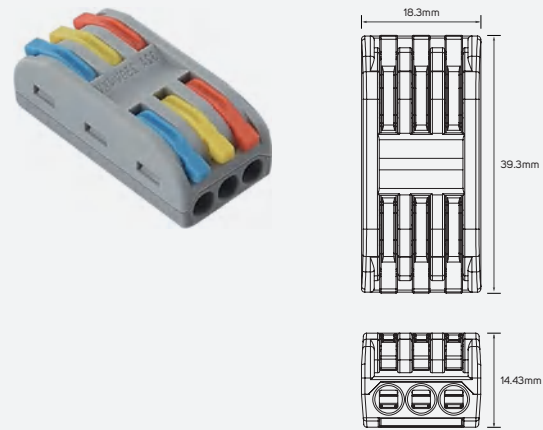
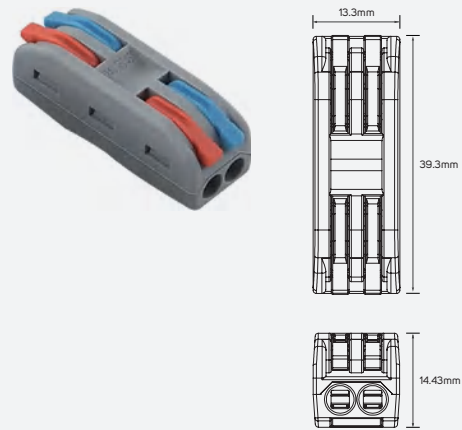
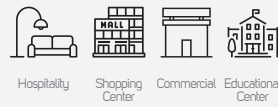

- 613625
- 613626
- Nylon+Copper
- AC100-240V

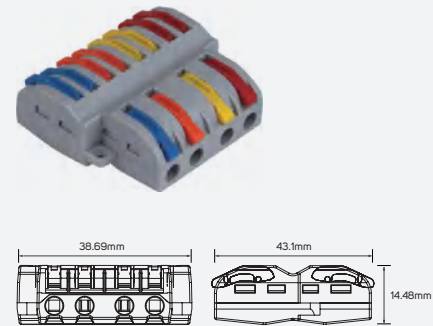
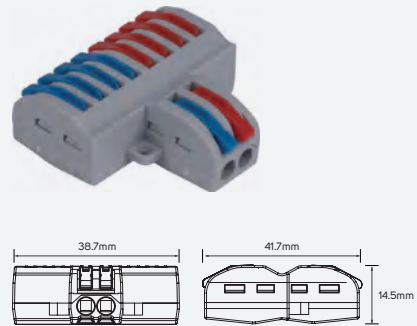

- 613187
- 613190
- Nylon
- AC100-240V

Indoor Connector

Power

Technical Operating & Electrical Data

Input Voltage & Frequency AC220-240V, 50/60Hz
 Body Color White

Areas of Application

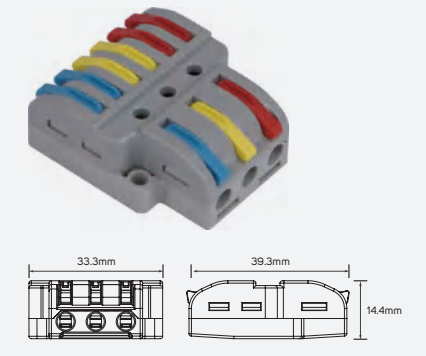
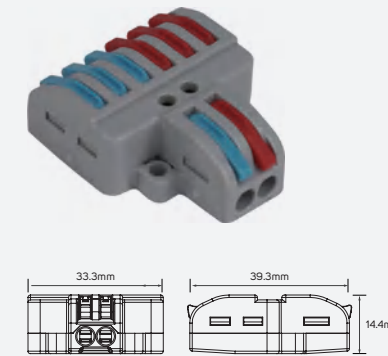
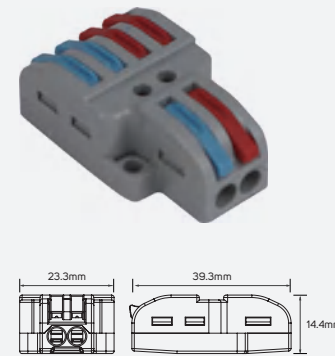

- 613185
- 613186
- 613188
- 613189
- PC
- AC100-240V

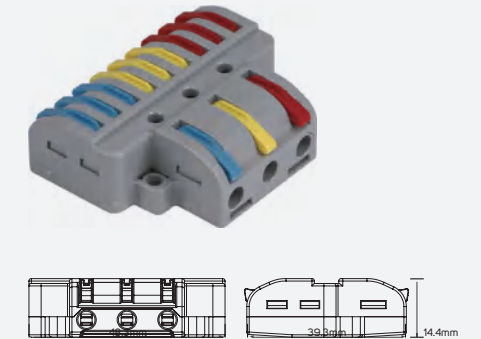

Power

Technical Operating & Electrical Data

Input Voltage & Frequency AC220-240V, 50/60Hz
 Body Color White

Areas of Application

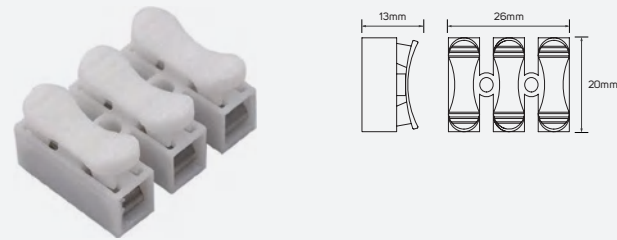
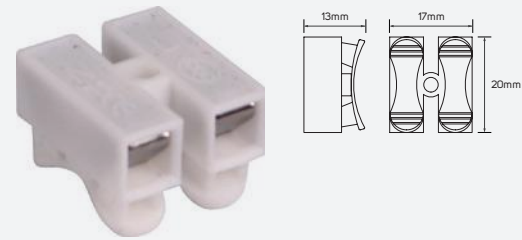
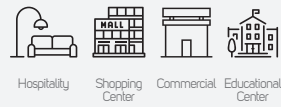

- 613183
- 613627
- Polypropylene
- ⏏ AC100-240V

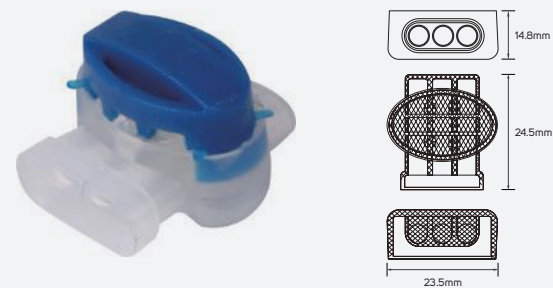

- 613184
- 613628
- Nylon
- Nylon+Copper
- ⏏ AC100-240V
- ⏏ AC100-240V

Beyond Light,
To the last details

Frames/Housing

- Frame
- Gypsum Frame
- Surface Mounted Luminaire-Wall



Frame

Frame

Perpetual

Technical Operating & Electrical Data

Input Voltage & Frequency	AC220-240V, 50/60Hz
Body Material	die-casting aluminum
IP Ratings	IP65
Lamp Holder Type	GU10

Areas of Application

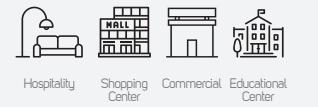

Dimensions Options



613064 - 613065

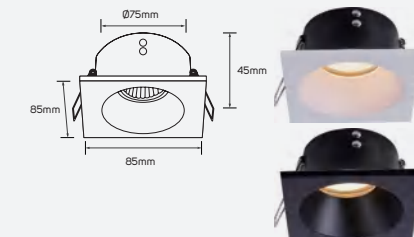

613066 - 613067



613068 - 613069



613070 - 613071



613072 - 613073

Family Product List

Code No.	Model No.	Body Color
● 613064	ILS085RRFW01	white
● 613065	ILS085RRFB01	black
● 613066	ILS085SRFW01	white
● 613067	ILS085SRFB01	black
● 613068	ILS087RRFW01	white
● 613069	ILS087RRFB01	black
● 613070	ILS084RRFW01	white
● 613071	ILS084RRFB01	black
● 613072	ILS083RRFW01	white
● 613073	ILS083RRFB01	black

Frame

Pioneer G1

Technical Operating & Electrical Data

Input Voltage & Frequency	AC220-240V, 50/60Hz
Body Material	Steel Housing & Die Cast Aluminum Rings
IP Ratings	IP20
Lamp Holder Type	GU10
Directional or Non Directional	Non Directional
Fixed or Adjustable	Adjustable
Wattage	Max. 9W
Mounting Type	Recessed luminaire

Areas of Application

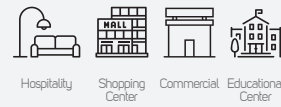

Dimensions Options



612463 - 612595

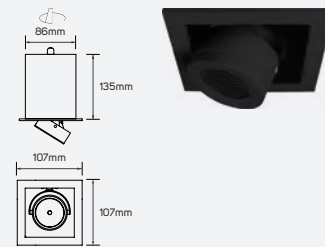

612596

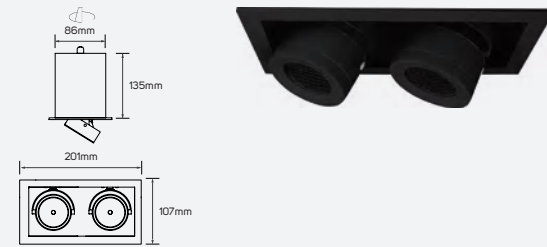

612597

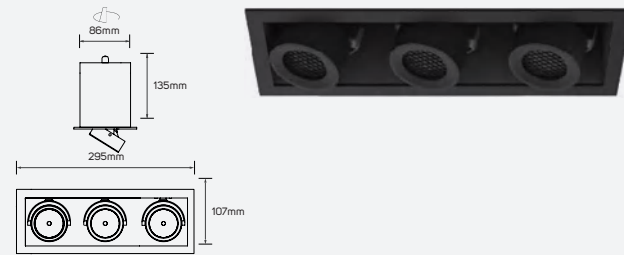

612598

Family Product List

Code No.	Model No.	Body Color	Cutting Size
● 612596	ILSARCF01	black	95x95mm
● 612597	ILSARCF04	black	95x190mm
● 612598	ILSARCF05	black	95x285mm
● 612463	ILSARCF01	white	Ø98mm
● 612595	ILSARCF01	black	Ø98mm

Frame

Pioneer G1

Technical Operating & Electrical Data

Input Voltage & Frequency	AC220-240V, 50/60Hz
Body Material	Steel Housing & Die Cast Aluminum Rings
IP Ratings	IP20
Lamp Holder Type	GU10
Directional or Non Directional	Non Directional
Fixed or Adjustable	Adjustable
Wattage	Max. 9W
Mounting Type	Recessed luminaire

Areas of Application



Dimensions Options

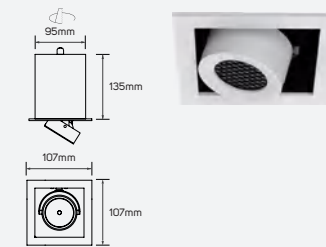

611543

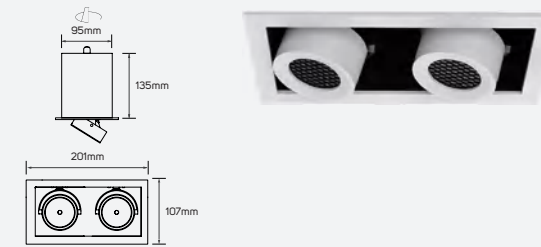

611544

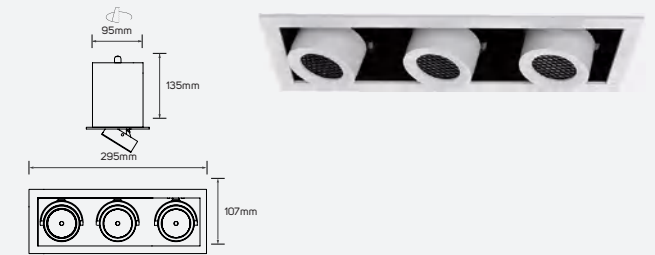

611545

Family Product List

Code No.	Model No.	Body Color	Cutting Size
● 611543	ILSARCF01	black+white	95x95mm
● 611544	ILSARCF04	black+white	95x190mm
● 611545	ILSARCF05	black+white	95x285mm

Frame

Pioneer G1

Technical Operating & Electrical Data

Input Voltage & Frequency	AC220-240V, 50/60Hz
Body Material	Metal
Lamp Holder Type	GU10

Areas of Application

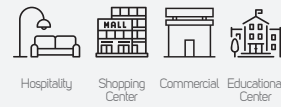

Dimensions Options

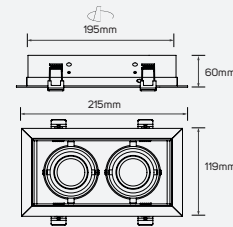
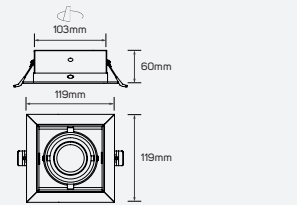

5101037

5101045

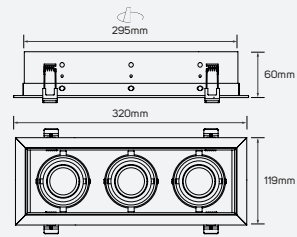

5101046

Family Product List

Code No.	Model No.	Body Color	Mounting Dimensions
5101037	ILS120SFBSB01	black+white	103x103mm
5101045	ILS215SFBSB01	black+white	103x195mm
5101046	ILS320SFBSB01	black+white	103x295mm

Frame

Pioneer G1

Technical Operating & Electrical Data

Input Voltage & Frequency	AC220-240V, 50/60Hz
Body Material	Metal
Lamp Holder Type	GU10

Areas of Application

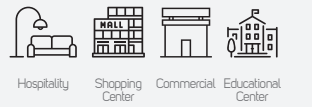

Dimensions Options

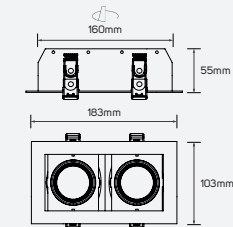
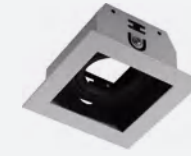
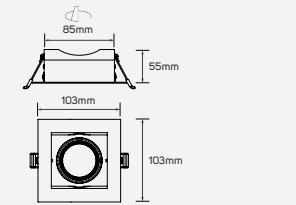

5101073

5101074

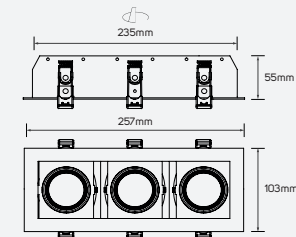

5101075

Family Product List

Code No.	Model No.	Body Color	Mounting Dimensions
5101073	ILS102SFWB01	black+white	85x85mm
5101074	ILS180SFWB01	black+white	85x160mm
5101075	ILS255SFWB01	black+white	85x235mm

Frame

Pioneer G1

Technical Operating & Electrical Data

Input Voltage & Frequency	AC220-240V, 50/60Hz
Body Material	Metal
Lamp Holder Type	GU10

Areas of Application

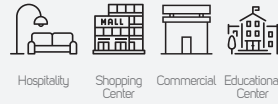

Dimensions Options

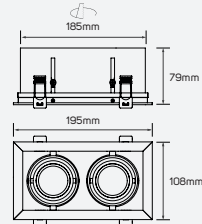
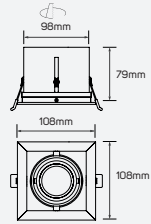

5101362

5101363

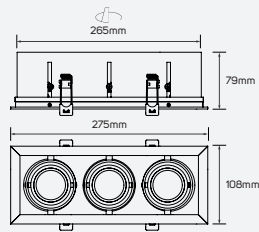

5101364

Family Product List

Code No.	Model No.	Body Color	Mounting Dimensions
5101362	ILSARCFR04	black+white	98x98mm
5101363	ILSARCFR05	black+white	98x185mm
5101364	ILSARCFR06	black+white	98x265mm

Frame

Pioneer G1

Technical Operating & Electrical Data

Input Voltage & Frequency	AC220-240V, 50/60Hz
Body Material	Metal
Lamp Holder Type	GU10

Areas of Application



Dimensions Options

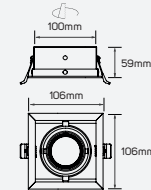

5101178-5101179

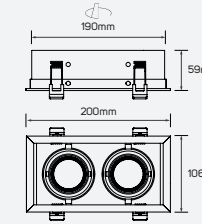

5101180-5101181

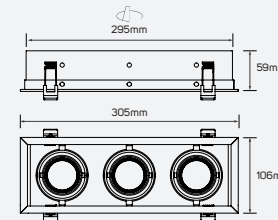

5101182-5101183

Family Product List

Code No.	Model No.	Body Color	Mounting Dimensions
5101178	ILS105SFW01	white	100x100mm
5101179	ILS105SFB01	black	100x100mm
5101180	ILS200SFW01	white	100x190mm
5101181	ILS200SFB01	black	100x190mm
5101182	ILS305SFW01	white	100x295mm
5101183	ILS305SFB01	black	100x295mm

Frame

Pioneer G1

Technical Operating & Electrical Data

Input Voltage & Frequency	AC220-240V, 50/60Hz
Body Material	Aluminum
Lamp Holder Type	GU10

Areas of Application

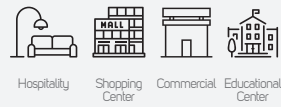

Dimensions Options

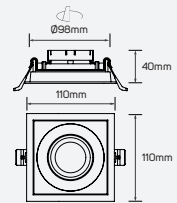

5101012-5101050

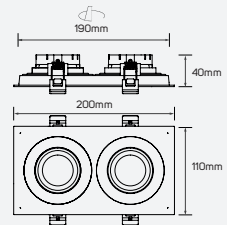

5101013-5101051



Family Product List

Code No.	Model No.	Body Color	Mounting Dimensions
● 5101012	ILS110SFW01	white	98x98mm
● 5101013	ILS210SFW01	white	98x190mm
● 5101050	ILS110SFB01	black	98x98mm
● 5101051	ILS210SFB01	black	190x98mm



Frame

Pioneer G1

Technical Operating & Electrical Data

Input Voltage & Frequency	AC220-240V, 50/60Hz
Body Material	Metal
Lamp Holder Type	GU10

Areas of Application

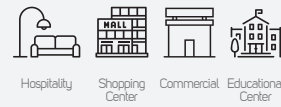

Dimensions Options

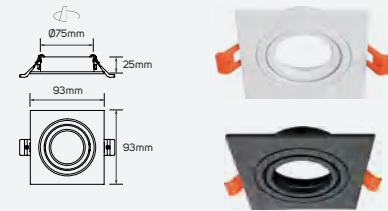

5101098-5101386

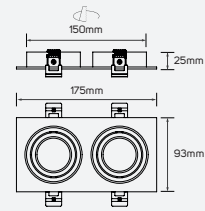

5101099-5101387

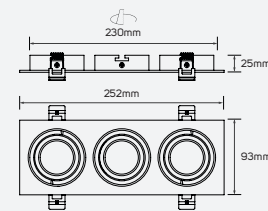

5101100-5101388

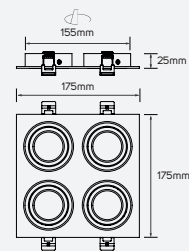

5101101-5101389



Family Product List

Code No.	Model No.	Code No.	Model No.	Mounting Dimensions
● 5101098	ILS093SFW04	● 5101386	ILS092FRCFR01	Ø75mm
● 5101099	ILS181SFW01	● 5101387	ILS175FRCFR01	150x75mm
● 5101100	ILS256SFW01	● 5101388	ILS252FRCFR01	230x75mm
● 5101101	ILS175SFW02	● 5101389	ILS175FRCFR02	155x155mm

Frame

Pioneer G1

Technical Operating & Electrical Data

Input Voltage & Frequency	AC220-240V, 50/60Hz
Body Material	Aluminum
Lamp Holder Type	MR11

Areas of Application



Dimensions Options



5101671 - 5101672 - 5101673 - 5101674



5101675 - 5101676

Reflector Options

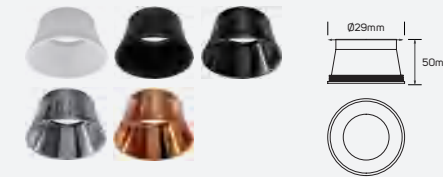

5101677 - 5101678 - 5101679 - 5101680 - 5101681

Family Product List

Code No.	Model No.	Body Color	Cutting Size
● 5101671	ILS50FRCFMR11W01	white	Ø45mm
● 5101672	ILS50FRCFMR11WB01	white+black	Ø45mm
● 5101673	ILS50FRCFMR11WG01	white	Ø45mm
● 5101674	ILS50FRCFMR11B01	black	Ø45mm
● 5101675	ILS65FRCFMR11ORW01	white	Ø55mm
● 5101676	ILS65FRCFMR11ORB01	black	Ø55mm

Reflector Specifications

Code No.	Model No.	Body Color
● 5101677	ILS50FRCFMR11IRW01	white
● 5101678	ILS50FRCFMR11IRB01	black
● 5101679	ILS50FRCFMR11IRB02	chrome black
● 5101680	ILS50FRCFMR11IRS01	anti-glare silver
● 5101681	ILS50FRCFMR11IRRG01	rosy gold

Frame

Pioneer G1

Technical Operating & Electrical Data

Input Voltage & Frequency	AC220-240V, 50/60Hz
Body Material	Aluminum
Lamp Holder Type	MR11

Dimensions Options

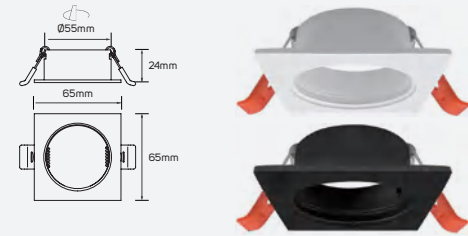

5101682 - 5101683

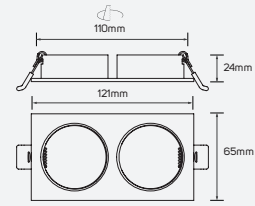

5101684 - 5101685



Reflector Options

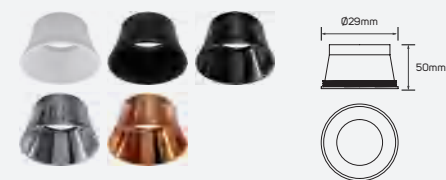

5101677 - 5101678 - 5101679 - 5101680 - 5101681

Family Product List

Code No.	Model No.	Body Color	Cutting Size
● 5101682	ILS65FSCFMR110RW01	white	Ø55mm
● 5101683	ILS65FSCFMR110RB01	black	Ø55mm
● 5101684	ILS65FSCFMR110RW02	white	110x55mm
● 5101685	ILS65FSCFMR110RB02	black	110x55mm

Reflector Specifications

Code No.	Model No.	Body Color	Cutting Size
● 5101677	ILS50FRCFMR111RW01	white	
● 5101678	ILS50FRCFMR111RB01	black	
● 5101679	ILS50FRCFMR111RB02	chrome black	
● 5101680	ILS50FRCFMR111RS01	anti-glare silver	
● 5101681	ILS50FRCFMR111RRG01	rosy gold	

Areas of Application

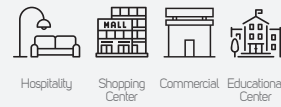

Frame

Pioneer G1

Technical Operating & Electrical Data

Input Voltage & Frequency	AC220-240V, 50/60Hz
Body Material	Aluminum
Lamp Holder Type	MR11

Dimensions Options



5101686 - 5101689

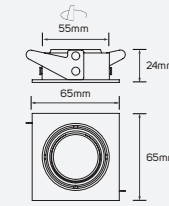

5101687 - 5101690

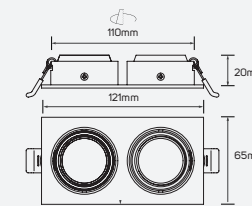

5101688 - 5101691



Reflector Options



5101692 - 5101693 - 5101694 - 5101695 - 5101696

Family Product List

Code No.	Model No.	Body Color	Cutting Size
● 5101686	ILS65ARCFMR110RW01	white	Ø55mm
● 5101687	ILS65ASCFMR110RW01	white	Ø55mm
● 5101688	ILS121ASCFMR110RW01	white	110x55mm
● 5101689	ILS65ARCFMR110RB01	black	Ø55mm
● 5101690	ILS65ASCFMR110RB01	black	Ø55mm
● 5101691	ILS121ASCFMR110RB01	black	110x55mm

Areas of Application

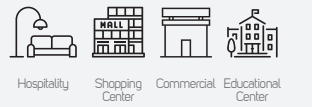

Reflector Specifications

Code No.	Model No.	Body Color	Cutting Size
● 5101692	ILS37FRCFMR11IRW01	white	
● 5101693	ILS37FRCFMR11IRB01	black	
● 5101694	ILS37FRCFMR11IRB02	anti-glare black	
● 5101695	ILS37FRCFMR11IRS01	anti-glare silver	
● 5101696	ILS37FRCFMR11IRRG01	rosy gold	

Frame

Pioneer G1

Technical Operating & Electrical Data

Input Voltage & Frequency	AC220-240V, 50/60Hz
Body Material	Aluminum
Lamp Holder Type	MR11
Directional or Non Directional	Non Directional

Areas of Application

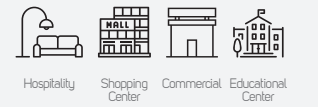

Dimensions Options

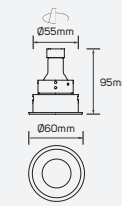

613243 - 613030 - 613031

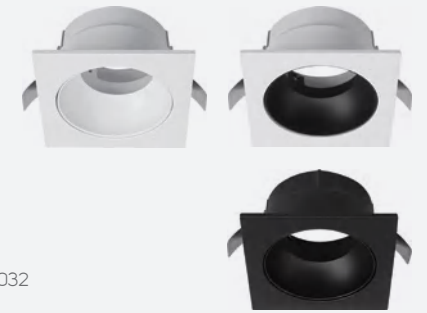
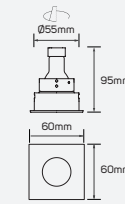

613244 - 613033 - 613032

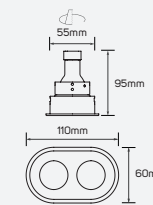

613034 - 613035

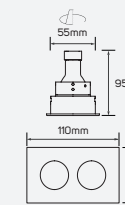

613036 - 613037

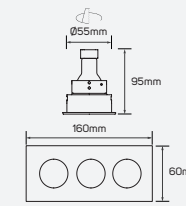

613038 - 613039

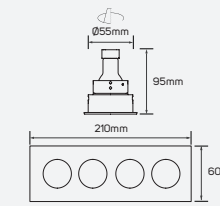

613040 - 613041

Family Product List

Code No.	Model No.	Body Color	Cutting Size
● 613243	ILSFRCF01	white	Ø55mm
◐ 613030	ILSFRCF01	white+black	Ø55mm
● 613031	ILSFRCF01	black	Ø55mm
◐ 613034	ILSFRCF03	white+black	55x103mm
● 613035	ILSFRCF03	black	55x103mm
● 613244	ILSFRCF02	white	Ø55mm
● 613033	ILSFRCF02	black	Ø55mm
◐ 613032	ILSFRCF02	white+black	Ø55mm
◐ 613036	ILSFRCF04	white+black	55x103mm
● 613037	ILSFRCF04	black	55x103mm
◐ 613038	ILSFRCF05	white+black	55x153mm
● 613039	ILSFRCF05	black	55x153mm
◐ 613040	ILSFRCF06	white+black	55x203mm
● 613041	ILSFRCF06	black	55x203mm



Frame

Pioneer MG1

Technical Operating & Electrical Data

Input Voltage & Frequency	AC220-240V, 50/60Hz
Body Material	Aluminum
Lamp Holder Type	MR11
IP Rating	IP20
Directional or Non Directional	Non Directional
Maximum Wattage	Max.9W

Dimensions Options

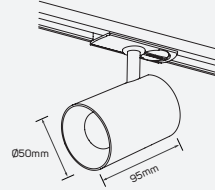

613292 - 613291

Family Product List

Code No.	Model No.	Body Color	Cutting Size
● 613292	ILSATMF73	black	Ø50x95mm
◐ 613291	ILSATMF73	white+black	Ø50x95mm

Areas of Application

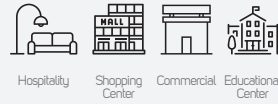

Frame

Pioneer MG3

Technical Operating & Electrical Data

Input Voltage & Frequency	AC220-240V, 50/60Hz
Body Material	Aluminum
Lamp Holder Type	MR11
IP Rating	IP20
Directional or Non Directional	Non Directional
Maximum Wattage	Max.9W

Dimensions Options

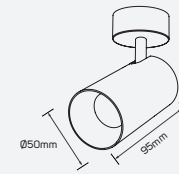

613284 - 613283

Family Product List

Code No.	Model No.	Body Color	Cutting Size
● 613284	ILSASMCF72	black	Ø50x95mm
◐ 613283	ILSASMCF72	white+black	Ø50x95mm

Areas of Application



Frame

Pioneer MG2

Technical Operating & Electrical Data

Input Voltage & Frequency	AC220-240V, 50/60Hz
Body Material	Aluminum
Lamp Holder Type	MR11
IP Rating	IP20
Directional or Non Directional	Non Directional
Maximum Wattage	Max.9W

Dimensions Options

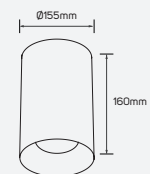

613276 - 613275

Family Product List

Code No.	Model No.	Body Color	Cutting Size
● 613276	ILSASMCF68	black	Ø50x90mm
◐ 613275	ILSASMCF68	white+black	Ø50x90mm

Areas of Application

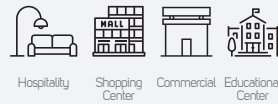

Frame

Pioneer MG4

Technical Operating & Electrical Data

Input Voltage & Frequency	AC220-240V, 50/60Hz
Body Material	Aluminum
Lamp Holder Type	MR11
IP Rating	IP20
Directional or Non Directional	Non Directional
Maximum Wattage	Max.9W

Dimensions Options

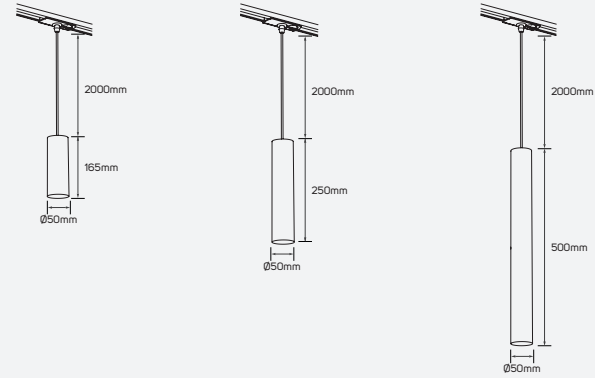

613295 - 613296 613297 - 613298 613299 - 613300

Family Product List

Code No.	Model No.	Body Color
613295	ILSATMF75	white+black
613296	ILSATMF75	black
613297	ILSATMF76	white+black
613298	ILSATMF76	black
613299	ILSATMF77	white+black
613300	ILSATMF77	black

Areas of Application

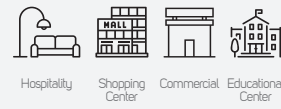

Frame

Pioneer MG5

Technical Operating & Electrical Data

Input Voltage & Frequency	AC220-240V, 50/60Hz
Body Material	Aluminum
Lamp Holder Type	MR11
IP Rating	IP20
Directional or Non Directional	Non Directional
Maximum Wattage	Max.9W

Dimensions Options

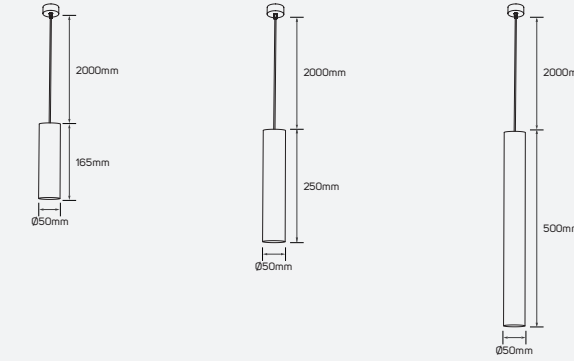

613245 - 613246 613247 - 613248 613249 - 613250

Family Product List

Code No.	Model No.	Body Color
613245	ILSFMPF86	white+black
613246	ILSFMPF86	black
613247	ILSFMPF87	white+black
613248	ILSFMPF87	black
613249	ILSFMPF88	white+black
613250	ILSFMPF88	black

Areas of Application





Frame

Pioneer A

Technical Operating & Electrical Data

Input Voltage & Frequency	AC220-240V, 50/60Hz
Body Material	Aluminum
Lamp Holder Type	AR111
IP Rating	IP20

Areas of Application

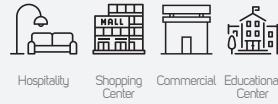

Dimensions Options



5101061-5101062-5101160

5101063-5101064-5101161

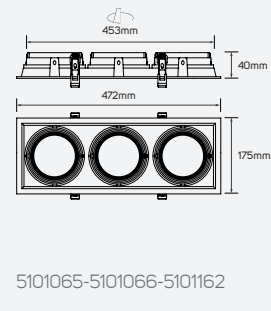

5101065-5101066-5101162

Family Product List

Code No.	Model No.	Mounting Dimensions
● 5101061	ILS175SFW01	160x160mm
● 5101062	ILS175SFB01	160x160mm
● 5101063	ILS324SFW01	160x305mm
● 5101064	LS324SFB01	160x305mm
● 5101065	LS470SFW01	160x453mm
● 5101066	LS470SFB01	160x453mm
● 5101160	ILS175SFS01	160x160mm
● 5101161	ILS324SFS01	160x305mm
● 5101162	ILS470SFS01	160x453mm

Frame

Pioneer A

Technical Operating & Electrical Data

Input Voltage & Frequency	AC220-240V, 50/60Hz
Body Material	Aluminum
Lamp Holder Type	AR111
IP Rating	IP20

Areas of Application

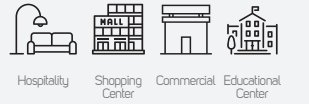

Dimensions Options

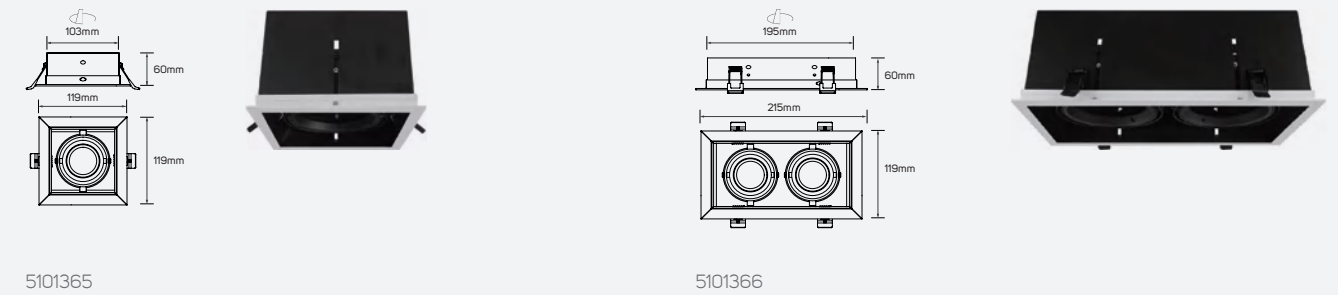

5101365

5101366

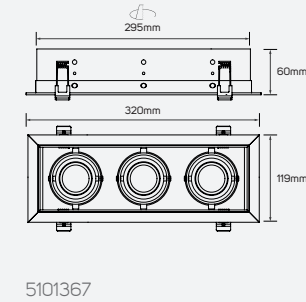

5101367

Family Product List

Code No.	Model No.	Mounting Dimensions
● 5101365	ILSARCFR07	163x163mm
● 5101366	ILSARCFR08	163x310mm
● 5101367	ILSARCFR09	163x457mm

Frame

Pioneer G2

Technical Operating & Electrical Data

Input Voltage & Frequency AC220-240V, 50/60Hz
 Body Material Aluminum



Body Color Options



5101054 5101055 5101056



5101057 5101058

Dimensions Options

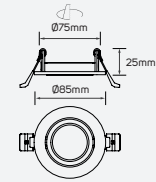

Family Product List

Code No.	Model No.	Mounting Dimensions
5101054	ILS085SFW02	Ø75mm
5101055	ILS85ARCFR01	Ø75mm
5101056	ILS85ARCFR01	Ø75mm
5101057	ILS85ARCFR01	Ø75mm
5101058	ILS085SFB01	Ø75mm

Areas of Application

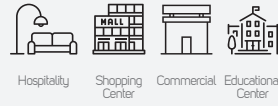

Frame

Pioneer G2

Technical Operating & Electrical Data

Input Voltage & Frequency AC220-240V, 50/60Hz
 Body Material Aluminum



Dimensions Options



5101006



5101007

Family Product List

Code No.	Model No.	Mounting Dimensions
5101006	ILS108SFW01	Ø90mm
5101007	ILS089SFW01	Ø80mm



Dimensions Options

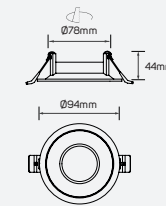

5101079-5101080-5101081

Family Product List

Code No.	Model No.	Mounting Dimensions
5101079	ILS095SFWB01	Ø78mm
5101080	ILS095SFWG01	Ø78mm
5101081	ILS095SFWS01	Ø78mm

Frame

Pioneer G2

Technical Operating & Electrical Data

Input Voltage & Frequency AC220-240V, 50/60Hz
 Body Material Aluminum

Areas of Application

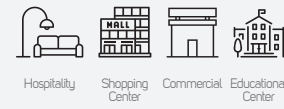

5101082 5101083 5101084 5101085

Dimensions Options

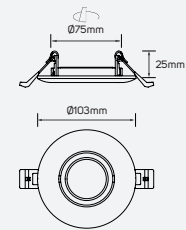

Family Product List

Code No.	Model No.	Mounting Dimensions
5101082	ILS103SFW01	Ø75mm
5101083	ILS103SFWG01	Ø75mm
5101084	ILS089SFW01	Ø75mm
5101085	ILS095SFWB01	Ø75mm



Dimensions

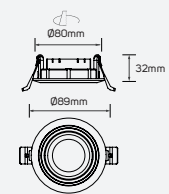

Family Product List

Code No.	Model No.	Mounting Dimensions	Cap Type
5101135	ILS095SFWG01	Ø75mm	GU10

Frame

Pioneer G2

Technical Operating & Electrical Data

Input Voltage & Frequency AC220-240V, 50/60Hz
 Body Material Aluminum

Areas of Application



5101136 5101392

Dimensions

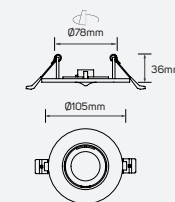

Family Product List

Code No.	Model No.	Mounting Dimensions	Cap Type
5101136	ILS105SFW01	Ø75mm	GU10
5101392	ILS105FRFCR02	Ø75mm	GU10



Dimensions

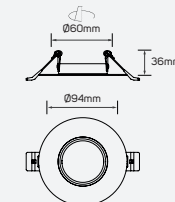

Family Product List

Code No.	Model No.	Mounting Dimensions
5101141	ILS094SFW01	Ø60mm
5101142	ILS094SFG01	Ø60mm
5101143	ILS094SFB01	Ø60mm
5101144	ILS094SFS01	Ø60mm

Frame

Pioneer G2

Technical Operating & Electrical Data

Input Voltage & Frequency	AC220-240V, 50/60Hz
Body Material	Aluminum
IP Rating	IP20



5101059-5101231

Dimensions

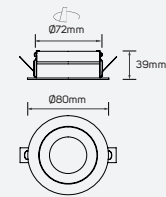

Family Product List

Code No.	Model No.	Mounting Dimensions
● 5101059	ILS080SFW01	Ø72mm
● 5101060	ILS080SFW02	Ø72mm
● 5101231	ILS080SFWB01	Ø72mm
● 5101232	ILS080SFWB02	Ø72mm

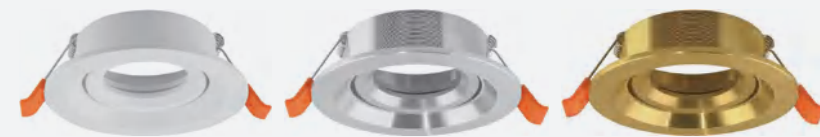

Dimensions

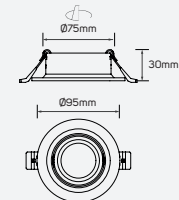

Family Product List

Code No.	Model No.	Mounting Dimensions
● 5101132	ILS093SFW01	Ø75mm
● 5101133	ILS093SFS01	Ø75mm
● 5101134	ILS093SFG01	Ø75mm

Areas of Application



Frame

Pioneer G2

Technical Operating & Electrical Data

Input Voltage & Frequency	AC220-240V, 50/60Hz
Body Material	Aluminum
IP Rating	IP20



5101126-5101127

5101380-5101381

Dimensions

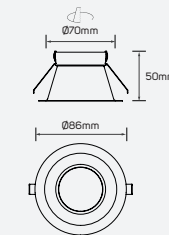

Family Product List

Code No.	Model No.	Mounting Dimensions	Cap Type
● 5101126	ILS086SFS01	Ø70mm	GU10
● 5101127	ILS086SFG01	Ø70mm	GU10
● 5101130	ILS086SFS02	Ø70mm	GU10
● 5101131	ILS086SFG02	Ø70mm	GU10
● 5101380	ILS85FRCFR01	Ø70mm	GU10
● 5101381	ILS85FRCFR01	Ø70mm	GU10
● 5101382	ILS85FRCFR02	Ø70mm	GU10
● 5101383	ILS85FRCFR02	Ø70mm	GU10

Areas of Application

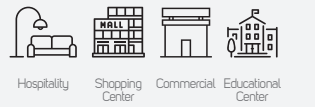

Frame

Pioneer G2

Technical Operating & Electrical Data

Input Voltage & Frequency	AC220-240V, 50/60Hz
Body Material	Aluminum
IP Rating	IP20



5101137-5101138-5101139-5101140

Dimensions

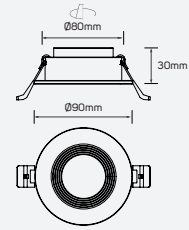

Family Product List

Code No.	Model No.	Mounting Dimensions
5101137	ILS090SFW01	Ø80mm
5101138	ILS090SFWS01	Ø80mm
5101139	ILS090SFWG01	Ø80mm
5101140	ILS090SFWB01	Ø80mm



Dimensions

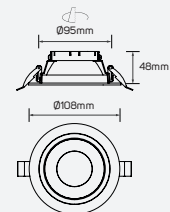

Family Product List

Code No.	Model No.	Mounting Dimensions	Cap Type
5101145	ILS108SFB02	Ø95mm	GU10

Areas of Application

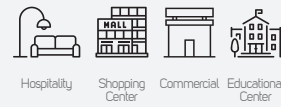

Frame

Pioneer G2

Technical Operating & Electrical Data

Input Voltage & Frequency	AC220-240V, 50/60Hz
Body Material	Aluminum
IP Rating	IP20



5101163-5101164-5101165-5101166

Dimensions

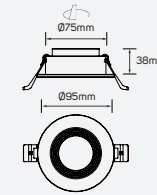

Family Product List

Code No.	Model No.	Mounting Dimensions	Cap Type
5101163	ILS090SFW02	Ø80mm	GU10
5101164	ILS090SFWS02	Ø80mm	GU10
5101165	ILS090SFWG02	Ø80mm	GU10
5101166	ILS090SFWB02	Ø80mm	GU10



5101167-5101168-5101169-5101170-5101171

Dimensions

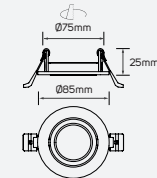

Family Product List

Code No.	Model No.	Mounting Dimensions
5101167	ILS095SFGGR01	Ø75mm
5101168	ILS095SFGB01	Ø75mm
5101169	ILS095SFGRS01	Ø75mm
5101170	ILS095SFGRG01	Ø75mm
5101171	ILS095SFW01	Ø75mm

Areas of Application

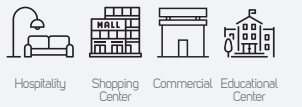

Frame

Pioneer G2

Technical Operating & Electrical Data

Input Voltage & Frequency	AC220-240V, 50/60Hz
Body Material	Aluminum
IP Rating	IP20



Dimensions

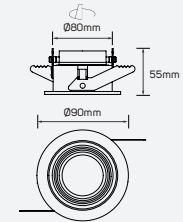

Family Product List

Code No.	Model No.	Mounting Dimensions
5101174	ILS090SFWB03	Ø80mm



Dimensions

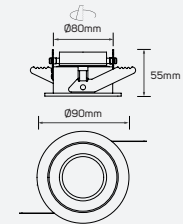

Family Product List

Code No.	Model No.	Mounting Dimensions
5101175	ILS090SFWS03	Ø80mm
5101176	ILS090SFWS04	Ø80mm
5101177	ILS090SFW05	Ø80mm

Areas of Application

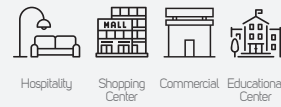

Frame

Pioneer G2

Technical Operating & Electrical Data

Input Voltage & Frequency	AC220-240V, 50/60Hz
Body Material	Aluminum
IP Rating	IP20



Dimensions

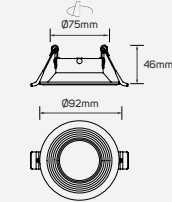

Family Product List

Code No.	Model No.	Mounting Dimensions
5101194	ILS091SFW01	Ø75mm
5101195	ILS091SFS01	Ø75mm
5101196	ILS091SFG01	Ø75mm
5101197	ILS091SFG02	Ø75mm
5101198	ILS091SFB01	Ø75mm
5101199	ILS091SFW02	Ø75mm

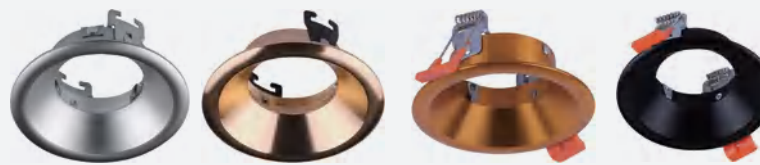

Dimensions

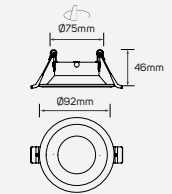

Family Product List

Code No.	Model No.	Mounting Dimensions
5101200	ILS091SFS02	Ø75mm
5101201	ILS091SFG03	Ø75mm
5101202	ILS091SFG04	Ø75mm
5101203	ILS091SFB02	Ø75mm

Frame

Pioneer G2

Technical Operating & Electrical Data

Input Voltage & Frequency	AC220-240V, 50/60Hz
Body Material	Aluminum
IP Rating	IP20



Family Product List

Code No.	Model No.	Mounting Dimensions
5101204	ILS081SFW01	Ø72mm
5101205	ILS081SFS01	Ø72mm
5101206	ILS081SFG01	Ø72mm
5101207	ILS081SFG02	Ø72mm
5101208	ILS081SFB01	Ø72mm
5101337	ILS081SFWB01	Ø72mm



Family Product List

Code No.	Model No.	Mounting Dimensions
5101291	ILS070SFW01	Ø65mm

Areas of Application

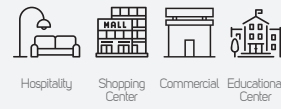

Dimensions

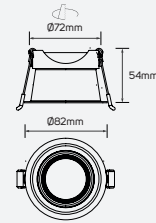

Frame

Pioneer G2

Technical Operating & Electrical Data

Input Voltage & Frequency	AC220-240V, 50/60Hz
Body Material	Aluminum
IP Rating	IP20



Dimensions

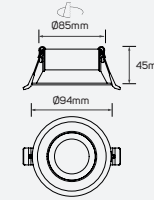

Dimensions

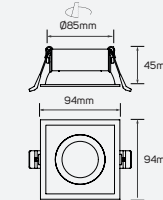

Family Product List

Code No.	Model No.	Mounting Dimensions
5101353	ILS93ARCFR01	Ø85mm
5101354	ILS93ARCFR01	Ø85mm
5101355	ILS90ARCFR01	Ø85mm
5101356	ILS90ARCFR01	Ø85mm



Dimensions

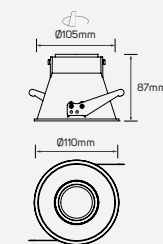

Family Product List

Code No.	Model No.	Mounting Dimensions
5101357	ILS110ARCFR01	Ø105mm
5101358	ILS110ARCFR01	Ø105mm

Areas of Application



Frame

Areas of Application

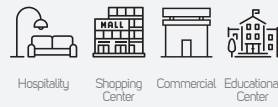

Pioneer G2

Technical Operating & Electrical Data

Input Voltage & Frequency	AC220-240V, 50/60Hz
Body Material	Aluminum
IP Rating	IP20



Dimensions

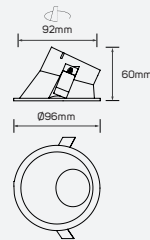

Dimensions

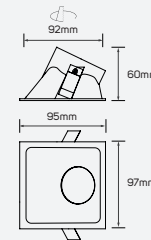

Family Product List

Code No.	Model No.	Mounting Dimensions
● 5101071	ILS96ARCFR01	92x92mm
● 5101072	ILS96ARCFR02	Ø89mm
● 5101378	ILS96ARCFR03	92x92mm
● 5101379	ILS96ARCFR04	Ø89mm



Dimensions

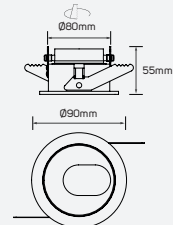

Dimensions

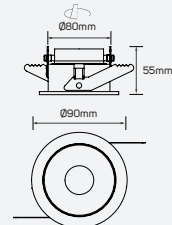

Family Product List

Code No.	Model No.	Mounting Dimensions
● 5101172	ILS090SFW03	Ø80mm
● 5101173	ILS090SFW04	Ø80mm

Frame

Areas of Application



Pioneer G2

Technical Operating & Electrical Data

Input Voltage & Frequency	AC220-240V, 50/60Hz
Body Material	Aluminum
IP Rating	IP20



Dimensions

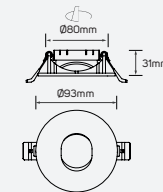

Dimensions

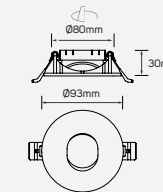

Family Product List

Code No.	Model No.	Mounting Dimensions
● 5101008	ILS093SFW01	Ø80mm
● 5101009	ILS093SFW03	Ø80mm



Dimensions

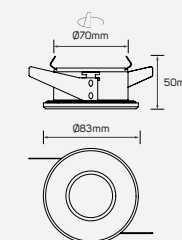

Family Product List

Code No.	Model No.	Mounting Dimensions
● 5101078	ILS96ARCFR01	Ø70mm

Frame

Pioneer G2

Technical Operating & Electrical Data

Input Voltage & Frequency	AC220-240V, 50/60Hz
Body Material	Aluminum
IP Rating	IP20

Areas of Application



Dimensions

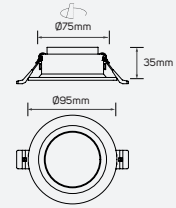

Family Product List

Code No.	Model No.	Mounting Dimensions
5101338	ILS96ARCFR02	Ø75mm
5101390	ILS96ARCFR03	Ø75mm
5101391	ILS96ARCFR04	Ø75mm



Dimensions

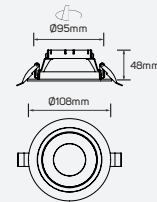

Family Product List

Code No.	Model No.	Mounting Dimensions
5101014	ILS96ARCFR02	Ø95mm
5101015	ILS96ARCFR03	Ø95mm

Frame

Pioneer G2

Technical Operating & Electrical Data

Input Voltage & Frequency	AC220-240V, 50/60Hz
Body Material	Aluminum
IP Rating	IP20

Areas of Application



Dimensions

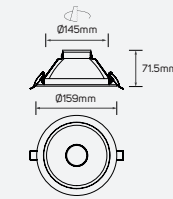

Dimensions

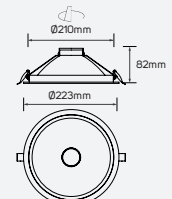

Family Product List

Code No.	Model No.	Mounting Dimensions
5101094	ILS96ARCFR01	Ø145mm
5101095	ILS96ARCFR02	Ø145mm
5101096	ILS96ARCFR03	Ø210mm
5101097	ILS96ARCFR01	Ø210mm



Dimensions

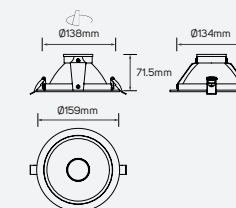

Dimensions

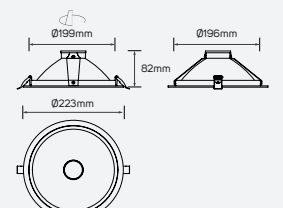

614268 - 614269

614270 - 614271

Family Product List

Code No.	Model No.	Mounting Dimensions
614268	ILS140REFRFW01	Ø138mm
614269	ILS140REFRFB01	Ø138mm
614270	ILS200REFRFW01	Ø199mm
614271	ILS200REFRFB01	Ø199mm

Frame

Pioneer G2

Areas of Application

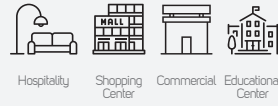

Technical Operating & Electrical Data

Input Voltage & Frequency	AC220-240V, 50/60Hz
Body Material	Aluminum
IP Rating	IP20



Dimensions

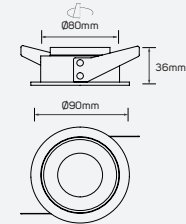

Family Product List

Code No.	Model No.	Mounting Dimensions
5101225	ILS090SFWB04	Ø80mm
5101226	ILS090SFWS05	Ø80mm
5101227	ILS090SFB01	Ø80mm



Dimensions

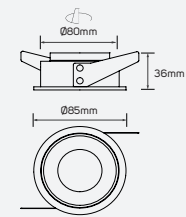

Family Product List

Code No.	Model No.	Mounting Dimensions
5101374	ILS085SFWB03	Ø80mm
5101375	ILS085SFWB03	Ø80mm
5101376	ILS085SFWB03	Ø80mm

Frame

Pioneer G2

Areas of Application

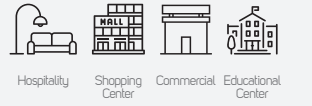

Technical Operating & Electrical Data

Input Voltage & Frequency	AC220-240V, 50/60Hz
Body Material	Aluminum
IP Rating	IP20



Dimensions

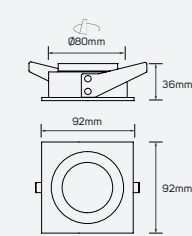

Family Product List

Code No.	Model No.	Mounting Dimensions
5101228	ILS090SFWB05	Ø80mm
5101229	ILS090SFWB05	Ø80mm
5101230	ILS090SFWB05	Ø80mm



Dimensions

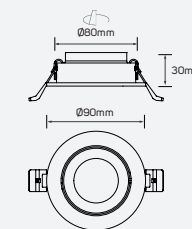

Family Product List

Code No.	Model No.	Mounting Dimensions
5101233	ILS090SFWB06	Ø80mm
5101234	ILS090SFWS07	Ø80mm
5101235	ILS090SFB03	Ø80mm

Frame

Pioneer G2

Areas of Application

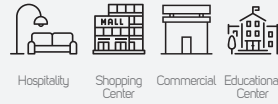

Technical Operating & Electrical Data

Input Voltage & Frequency	AC220-240V, 50/60Hz
Body Material	Aluminum
IP Rating	IP20



Dimensions

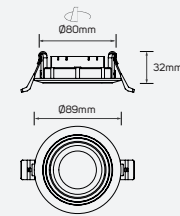

Family Product List

Code No.	Model No.	Mounting Dimensions
5101236	ILS089SFWB01	Ø80mm
5101237	ILS089SFWs01	Ø80mm
5101238	ILS089SFB02	Ø80mm



Dimensions

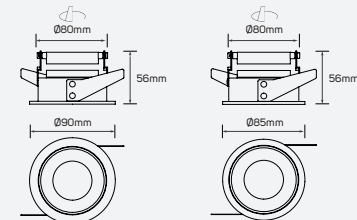

Family Product List

Code No.	Model No.	Mounting Dimensions
5101249	ILS090SFWB07	Ø80mm
5101250	ILS090SFWs08	Ø80mm
5101251	ILS090SFB04	Ø80mm

Frame

Pioneer G2

Areas of Application

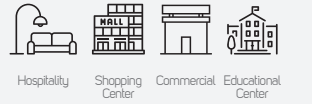

Technical Operating & Electrical Data

Input Voltage & Frequency	AC220-240V, 50/60Hz
Body Material	Aluminum
IP Rating	IP20



Dimensions

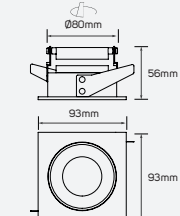

Family Product List

Code No.	Model No.	Mounting Dimensions
5101252	ILS090SFWB08	Ø80mm
5101253	ILS090SFWs09	Ø80mm
5101254	ILS090SFB05	Ø80mm

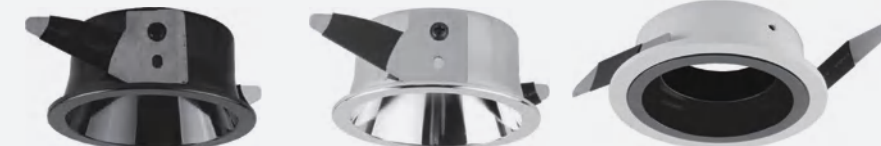

Dimensions

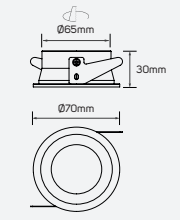

Family Product List

Code No.	Model No.	Mounting Dimensions
5101292	ILS070SFB01	Ø65mm
5101293	ILS070SFS01	Ø65mm
5101295	ILS085SFWB02	Ø65mm

Frame

Pioneer G3

Technical Operating & Electrical Data

Input Voltage & Frequency	AC220-240V, 50/60Hz
Body Material	Aluminum
IP Rating	IP20



Dimensions

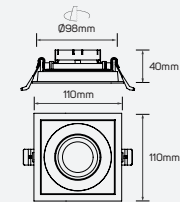

Family Product List

Code No.	Model No.	Mounting Dimensions
5101239	ILS110SFWB01	Ø98mm
5101240	ILS110SFWS01	Ø98mm
5101384	ILS110FRCFR01	190x98mm



Dimensions

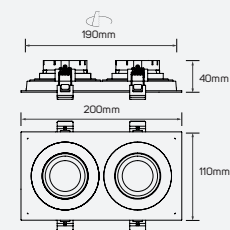

Family Product List

Code No.	Model No.	Mounting Dimensions
5101241	ILS200SFWB01	190x98mm
5101242	ILS200SFWS01	190x98mm
5101385	ILS200FRCFR01	190x98mm

Areas of Application

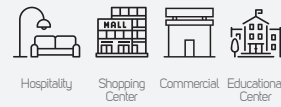

Frame

Pioneer G3

Technical Operating & Electrical Data

Input Voltage & Frequency	AC220-240V, 50/60Hz
Body Material	Aluminum
IP Rating	IP20

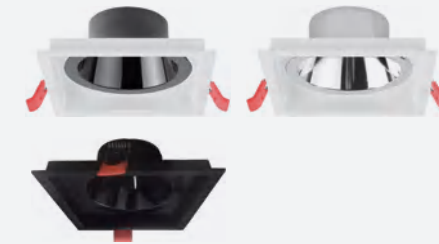

Dimensions

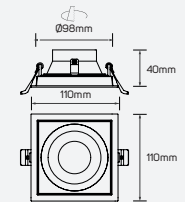

Family Product List

Code No.	Model No.	Mounting Dimensions
5101243	ILS110SFWB02	Ø98mm
5101244	ILS110SFWS02	Ø98mm
5101245	ILS110SFB02	Ø98mm



Dimensions

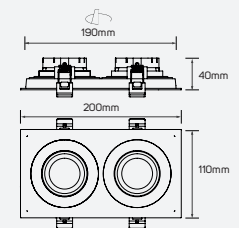

Family Product List

Code No.	Model No.	Mounting Dimensions
5101246	ILS200SFWB02	Ø80mm
5101247	ILS200SFWS02	Ø80mm
5101248	ILS200SFB02	Ø80mm

Areas of Application

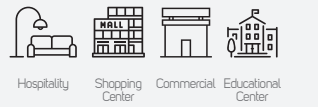

Frame

Pioneer G4

Technical Operating & Electrical Data

Input Voltage & Frequency	AC220-240V, 50/60Hz
Body Material	Aluminum
IP Rating	IP20



Areas of Application

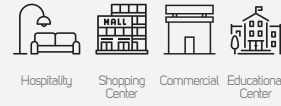

Dimensions

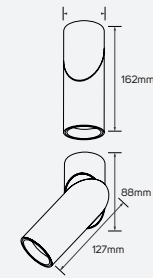

Kit

■ Metal

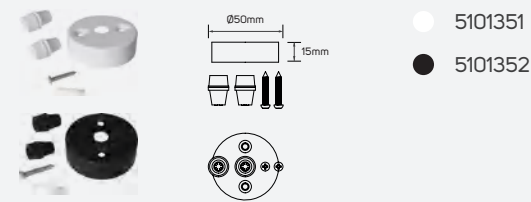

Family Product List

Code No.	Model No.	Maximum Wattage
● 613062	ILSASMCF01	Max.20
● 613063	ILSASMCF01	Max.20

Frame

Pioneer G5

Technical Operating & Electrical Data

Input Voltage & Frequency	AC220-240V, 50/60Hz
Body Material	Aluminum
IP Rating	IP20

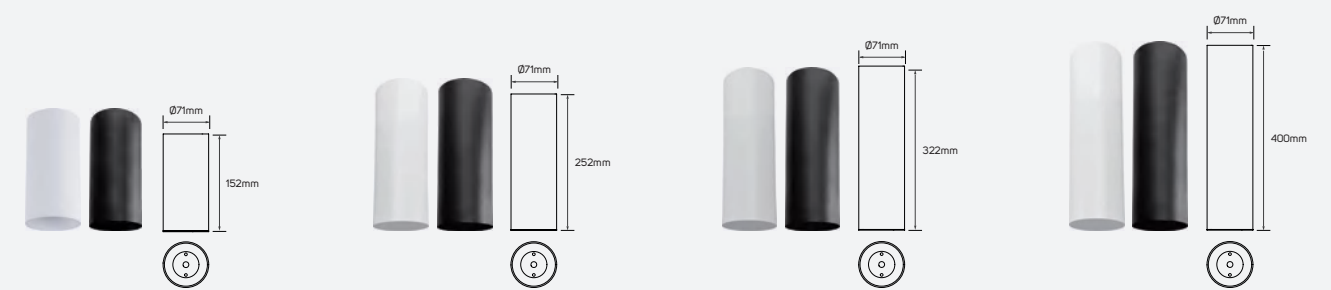

Areas of Application

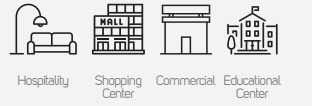

Reflector



- 5101324
 - 5101325
 - 5101326
 - 5101327
- Plastic

Kit



- 5101372
 - 5101373
- Metal

Family Product List

Code No.	Model No.
● 5101318	ILSSMSFW06
● 5101319	ILSSMSFB06
● 5101320	ILSSMSFW07
● 5101321	ILSSMSFB07
● 5101322	ILSSMSFWOS
● 5101323	ILSSMSFBOS
● 5101370	ILSFSMCFR07
● 5101371	ILSFSMCFR07

Frame

Pioneer G5

Technical Operating & Electrical Data

Input Voltage & Frequency	AC220-240V, 50/60Hz
Body Material	Aluminum
IP Rating	IP20

Areas of Application

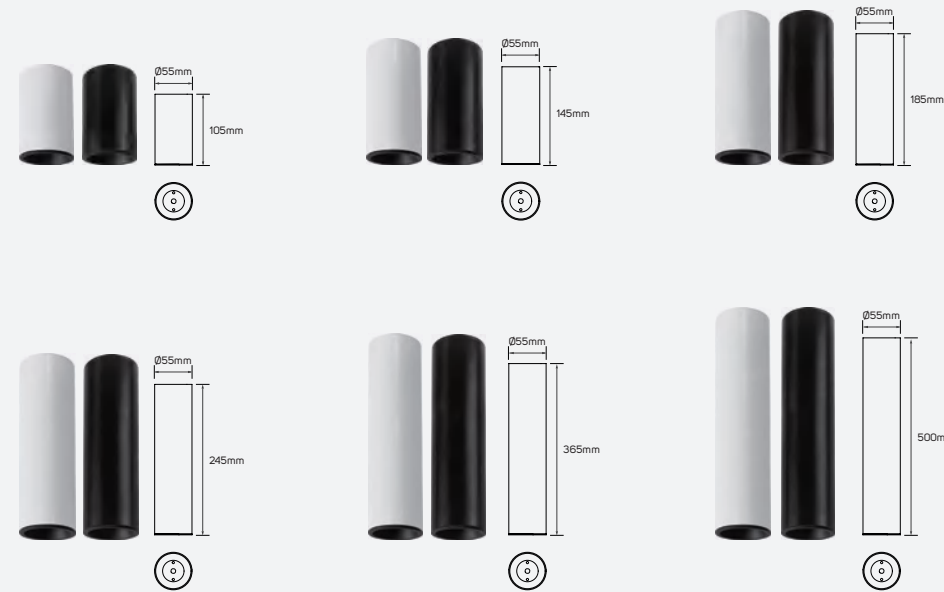
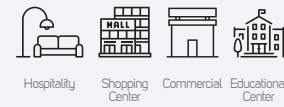

Kit

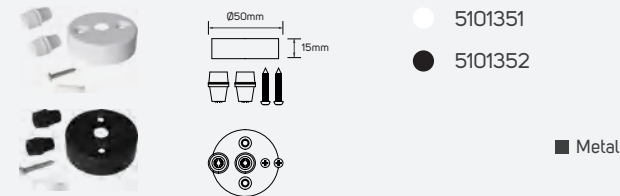

Family Product List

Code No.	Model No.
● 5101339	ILSFSMCFR01
● 5101340	ILSFSMCFR01
● 5101341	ILSFSMCFR02
● 5101342	ILSFSMCFR02
● 5101343	ILSFSMCFR03
● 5101344	ILSFSMCFR03
● 5101345	ILSFSMCFR04
● 5101346	ILSFSMCFR04
● 5101347	ILSFSMCFR05
● 5101348	ILSFSMCFR05
● 5101349	ILSFSMCFR06
● 5101350	ILSFSMCFR06

Frame

Pioneer P

Technical Operating & Electrical Data

Input Voltage & Frequency	AC220-240V, 50/60Hz
Body Material	Aluminum+Polycarbonate
IP Rating	IP20

Areas of Application

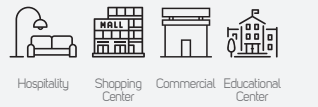

Dimensions

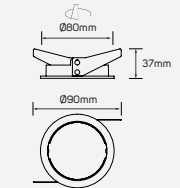

Reflector

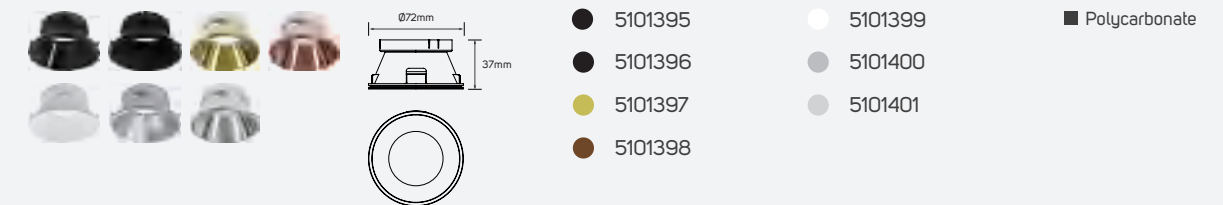

Honeycomb Holder

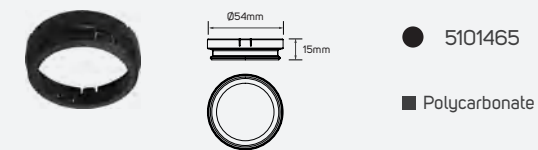

Honeycomb

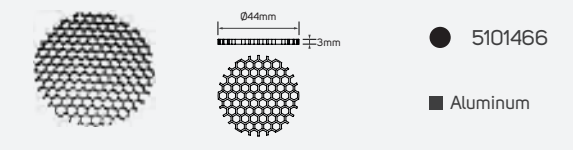

Family Product List

Code No.	Model No.	Mounting Dimensions
● 5101393	ILS090FRCFR01	Ø80mm
● 5101394	ILS090FRCFR01	Ø80mm

Frame

Pioneer P

Technical Operating & Electrical Data

Input Voltage & Frequency	AC220-240V, 50/60Hz
Body Material	Aluminum+PC lamp holder
IP Rating	IP20

Areas of Application

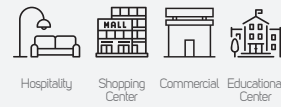

Dimensions

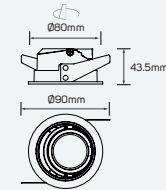

Reflector

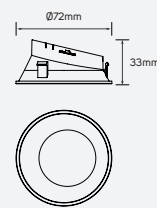

- 5101404
- 5101405
- 5101406
- 5101407
- 5101408
- 5101409
- 5101410

Honeycomb Holder

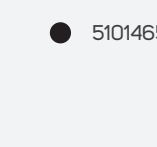

- 5101465

■ Polycarbonate

Honeycomb

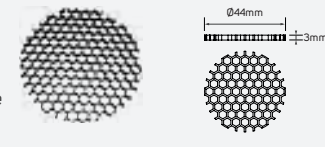

- 5101466

■ Aluminum

Family Product List

Code No.	Model No.	Mounting Dimensions
● 5101402	ILS090ARCFR01	Ø80mm
● 5101403	ILS090ARCFR01	Ø80mm

Frame

Pioneer P

Technical Operating & Electrical Data

Input Voltage & Frequency	AC220-240V, 50/60Hz
Body Material	Aluminum+Polycarbonate
IP Rating	IP20

Areas of Application



Dimensions

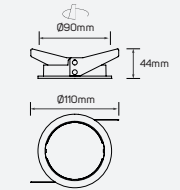

Reflector

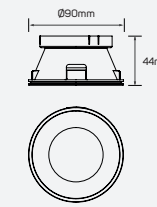

- 5101413
- 5101414
- 5101415
- 5101416
- 5101417
- 5101418
- 5101419

■ Polycarbonate

Honeycomb Holder

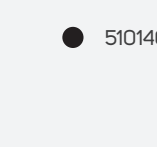

- 5101465

■ Polycarbonate

Honeycomb

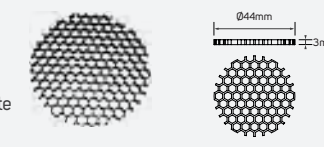

- 5101466

■ Aluminum

Family Product List

Code No.	Model No.	Mounting Dimensions
● 5101411	ILS110FRFCFR02	Ø90mm
● 5101412	ILS110FRFCFR02	Ø90mm

Frame

Pioneer P

Technical Operating & Electrical Data

Input Voltage & Frequency	AC220-240V, 50/60Hz
Body Material	Aluminum+PC lamp holder
IP Rating	IP20



Dimensions

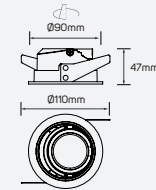

Areas of Application

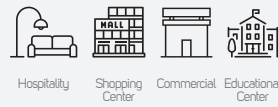

Reflector

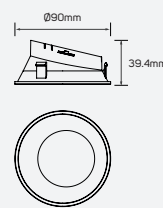
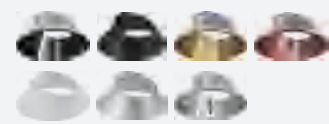

- 5101422
- 5101423
- 5101424
- 5101425
- 5101426
- 5101427
- 5101428
- Polycarbonate

Honeycomb Holder



- 5101465

■ Polycarbonate

Honeycomb

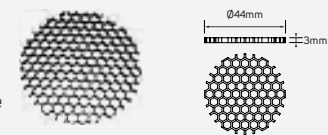

- 5101466

■ Aluminum

Family Product List

Code No.	Model No.	Mounting Dimensions
● 5101420	ILS110ARCFR02	Ø90mm
● 5101421	ILS110ARCFR02	Ø90mm

Frame

Pioneer P

Technical Operating & Electrical Data

Input Voltage & Frequency	AC220-240V, 50/60Hz
Body Material	Aluminum+PC lamp holder
IP Rating	IP20



Dimensions

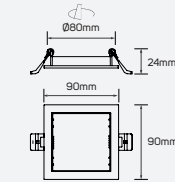

Areas of Application



Reflector

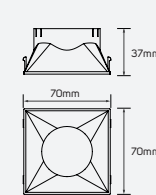
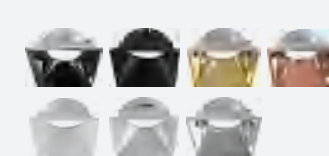

- 5101431
- 5101432
- 5101433
- 5101434
- 5101435
- 5101436
- 5101437
- Polycarbonate

Honeycomb Holder



- 5101465

■ Polycarbonate

Honeycomb

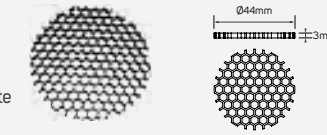

- 5101466

■ Aluminum

Family Product List

Code No.	Model No.	Mounting Dimensions
● 5101429	ILS090FRCFR02	80x80mm
● 5101430	ILS090FRCFR02	80x80mm

Frame

Pioneer P

Technical Operating & Electrical Data

Input Voltage & Frequency	AC220-240V, 50/60Hz
Body Material	Aluminum+PC lamp holder
IP Rating	IP20



Dimensions

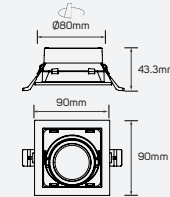

Areas of Application

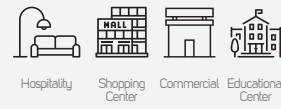

Reflector

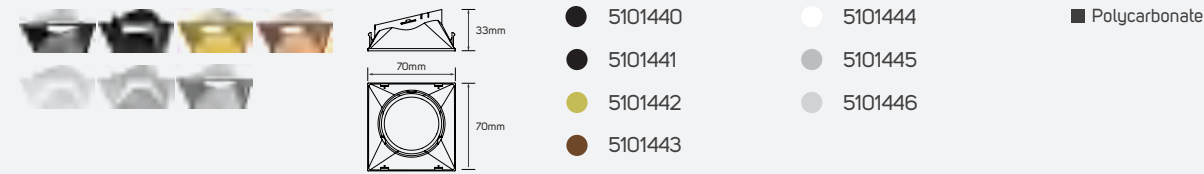

Honeycomb Holder



Honeycomb

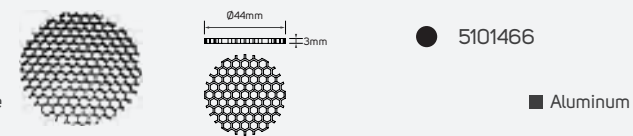

Family Product List

Code No.	Model No.	Mounting Dimensions
5101438	ILS090ARCFR02	80x80mm
5101439	ILS090FRCFR02	80x80mm

Frame

Pioneer P

Technical Operating & Electrical Data

Input Voltage & Frequency	AC220-240V, 50/60Hz
Body Material	Aluminum+PC lamp holder
IP Rating	IP20



Dimensions

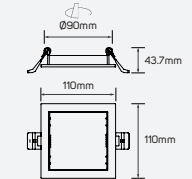

Areas of Application

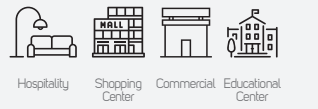

Reflector

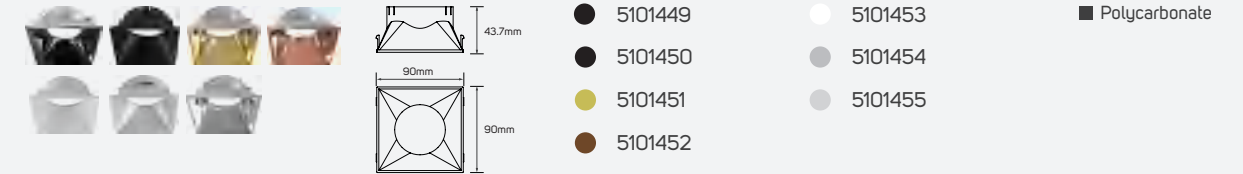

Honeycomb Holder



Honeycomb

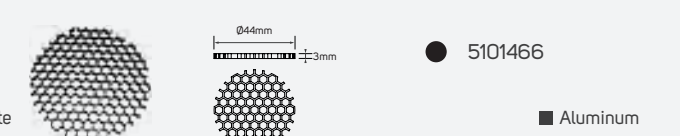

Family Product List

Code No.	Model No.	Mounting Dimensions
5101447	ILS110FRCFR03	90x90mm
5101448	ILS110FRCFR03	90x90mm

Frame

Pioneer P

Technical Operating & Electrical Data

Input Voltage & Frequency	AC220-240V, 50/60Hz
Body Material	Aluminum+PC lamp holder
IP Rating	IP20

Areas of Application

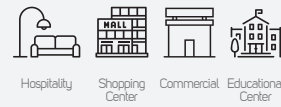

Dimensions

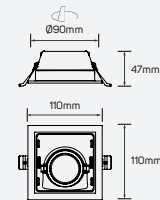

Reflector

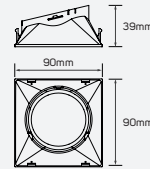
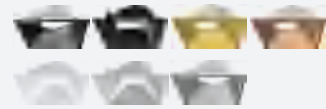

● 5101458	● 5101462	■ Polycarbonate
● 5101459	● 5101463	
● 5101460	● 5101464	
● 5101461		

Honeycomb Holder



● 5101465	■ Polycarbonate
-----------	-----------------

Honeycomb

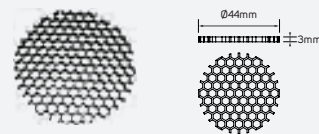

● 5101466	■ Aluminum
-----------	------------

Family Product List

Code No.	Model No.	Mounting Dimensions
● 5101456	ILS110ARCFR03	Ø90x90mm
● 5101457	ILS110ARCFR03	Ø90x90mm

Frame

Pioneer P

Technical Operating & Electrical Data

Input Voltage & Frequency	AC220-240V, 50/60Hz
Body Material	Aluminum+PC lamp holder
IP Rating	IP20

Areas of Application



5101704

Dimensions

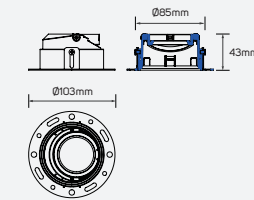

5101705

Dimensions

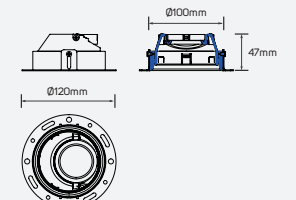

Family Product List

■ Aluminum+PC

Code No.	Model No.
● 5101704	ILS103TLFRMWB01
● 5101705	ILS113TLFRMWB01



5101706

Dimensions

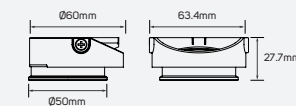

5101707

Dimensions

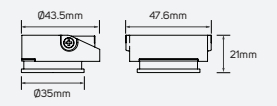

Family Product List

■ PC

Code No.	Model No.
● 5101706	ILS64CONVRCF01
● 5101707	ILS47CONVRCF01



Frame

Pioneer Q

Technical Operating & Electrical Data

Body Material	Aluminum+PC lamp holder
Cap Type	GU10&Mr16 & GUPO Module
IP Rating	IP20
Fixed or Adjustable	Fixed



Areas of Application

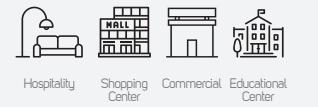

Dimensions

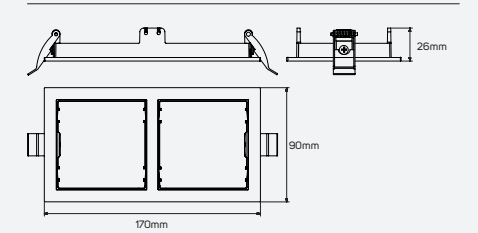

Reflector

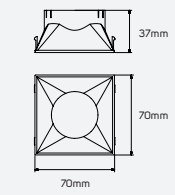

- 5101710
- 5101711
- 5101712
- 5101713
- 5101714
- Aluminum +PC

Family Product List

Code No.	Model No.	Mounting Dimensions
● 5101708	ILS090FRCFRW01	160x80mm
● 5101709	ILS090FRCFRB01	160x80mm

Frame

Pioneer Q

Technical Operating & Electrical Data

Body Material	Aluminum+PC lamp holder
Cap Type	GU10&Mr16 & GUPO Module
IP Rating	IP20
Fixed or Adjustable	Fixed

Areas of Application

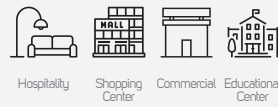

Dimensions

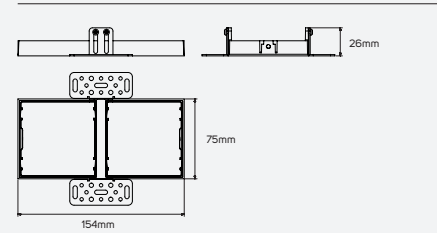

Reflector

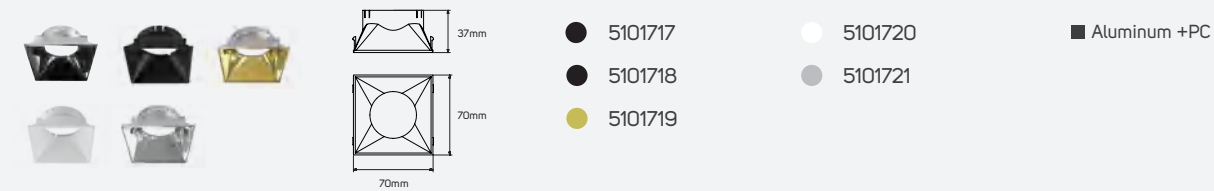

Family Product List

Code No.	Model No.	Mounting Dimensions
5101715	ILS122FRCFRW01	154x75mm
5101716	ILS122FRCFRB01	154x75mm

Frame

Pioneer R

Technical Operating & Electrical Data

Body Material	Aluminum
Cap Type	GU10&Mr16 & GUPO Module
Fixed or Adjustable	Fixed

Areas of Application



Dimensions

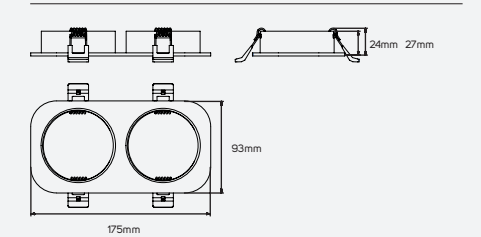

Reflector

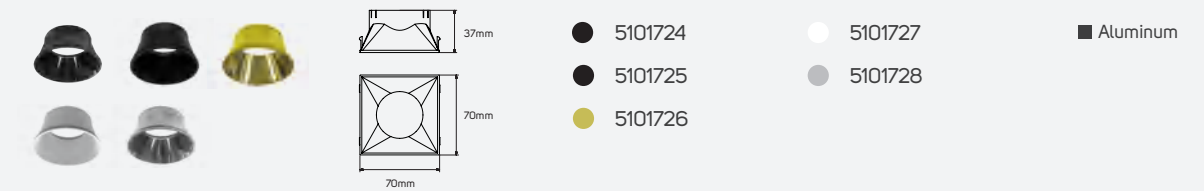

Family Product List

Code No.	Model No.	Mounting Dimensions
5101722	ILS093FRCFRW01	150x75mm
5101723	ILS093FRCFRB01	150x75mm

Frame

Pioneer R

Technical Operating & Electrical Data

Body Material	Aluminum + PC front lock
Cap Type	GU10&Mr16 & GUPO Module
Fixed or Adjustable	Adjustable



Dimensions

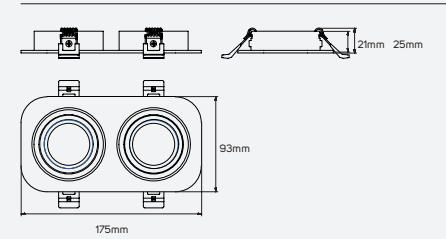

Reflector

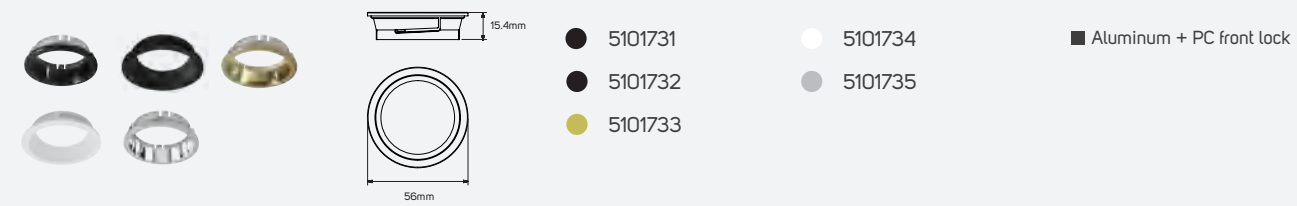

Family Product List

Code No.	Model No.	Mounting Dimensions
● 5101729	ILS093FRFCRW02	150x75mm
● 5101730	ILS093FRFCRB02	150x75mm

Frame

Pioneer R

Technical Operating & Electrical Data

Body Material	Aluminum
Cap Type	GU10&Mr16 & GUPO Module
Fixed or Adjustable	Fixed



Dimensions

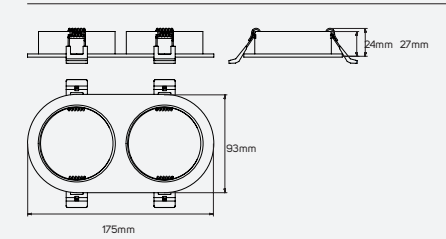

Reflector

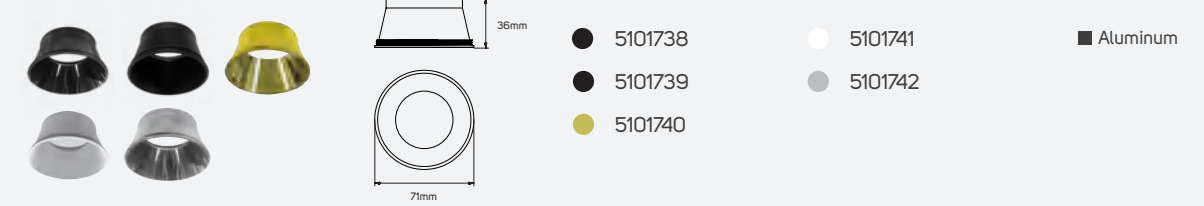

Family Product List

Code No.	Model No.	Mounting Dimensions
● 5101736	ILS093FRFCRW03	150x75mm
● 5101737	ILS093FRFCRB03	150x75mm

Frame

Pioneer R

Technical Operating & Electrical Data

Body Material	Aluminum + PC front lock
Cap Type	GU10&Mr16 & GUPO Module
Fixed or Adjustable	Adjustable



Dimensions

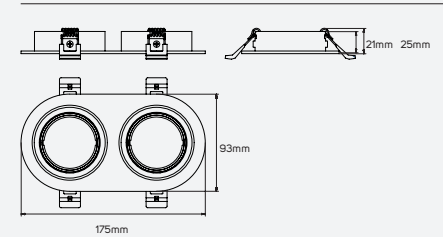

Reflector

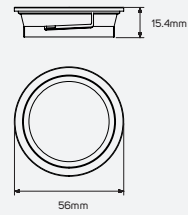

- 5101745
- 5101746
- 5101747
- 5101748
- 5101749
- Aluminum + PC front lock

Family Product List

Code No.	Model No.	Mounting Dimensions
● 5101743	ILS093FRFRW04	150x75mm
● 5101744	ILS093FRFRB04	150x75mm

Frame

Pioneer S

Technical Operating & Electrical Data

Body Material	Aluminum
Cap Type	AR111
Fixed or Adjustable	Adjustable



Dimensions

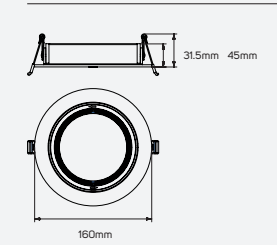

Areas of Application



Family Product List

Code No.	Model No.	Mounting Dimensions
● 5101750	ILS160ASCFMR11ORW01	Ø150mm
● 5101751	ILS160ASCFMR11ORB01	Ø150mm

Frame

Pioneer S

Technical Operating & Electrical Data

Body Material	Aluminum
Cap Type	AR11
Fixed or Adjustable	Adjustable

Areas of Application

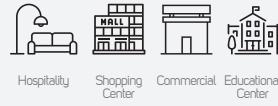

Dimensions

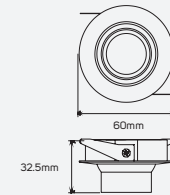

Frame

Pioneer S

Technical Operating & Electrical Data

Body Material	Aluminum
Fixed or Adjustable	Non Directional

Areas of Application

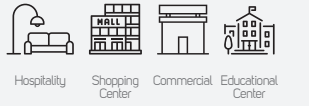

Dimensions

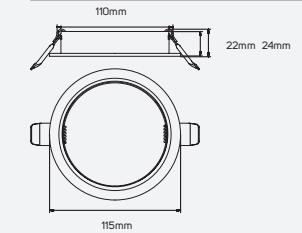

Reflector

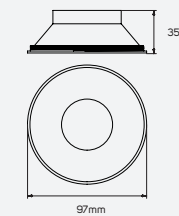

- 5101801
- 5101802
- 5101803
- 5101804
- 5101805
- 5101806
- 5101807
- 5101808

■ Aluminum

Family Product List

Code No.	Model No.	Mounting Dimensions
● 5101793	ILSAMR11FW01	Ø55mm
● 5101794	ILSAMR11FB01	Ø55mm

Family Product List

Code No.	Model No.	Mounting Dimensions
● 5101799	ILS113FRFCFW01	Ø100mm
● 5101800	ILS113FRFCFB01	Ø100mm

Frame

Pioneer S

Technical Operating & Electrical Data

Body Material	Aluminum
Cap Type	GU10
Fixed or Adjustable	Fixed



Dimensions

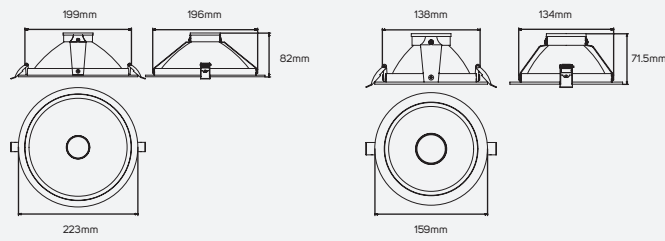

Family Product List

Code No.	Model No.	Mounting Dimensions
● 5101809	ILS140REFRFW01	Ø140mm
● 5101810	ILS140REFRFB01	Ø140mm
● 5101811	ILS200REFRFW01	Ø200mm
● 5101812	ILS200REFRFB01	Ø200mm

Areas of Application

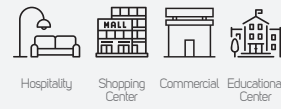

Frame

Pioneer T

Technical Operating & Electrical Data

Body Material	Aluminum+Metal
Cap Type	G9
Fixed or Adjustable	Adjustable



Areas of Application



Dimensions

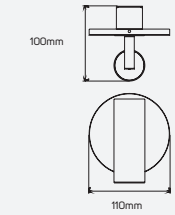

Family Product List

Code No.	Model No.	Mounting Dimensions
● 5101795	ILTMEFSWL40	40*85
● 5101796	ILTMEFSWL40	40*85
● 5101797	ILTMEFSWL40	40*85
● 5101798	ILTMEFSWL40	40*85



Gypsum Frame

Gypsum Frame

Cloudsoft Glow

Technical Operating & Electrical Data

Input Voltage & Frequency	AC220-240V, 50/60Hz
Body Material	Gypsum
IP Rating	IP20

Areas of Application

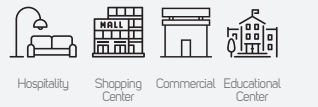

Dimensions

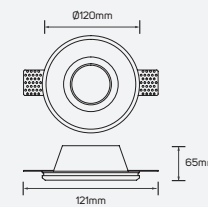

Dimensions

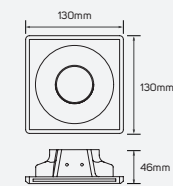

Dimensions

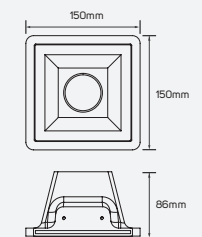

Dimensions

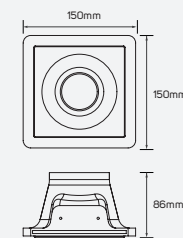

Dimensions

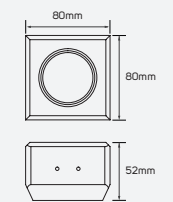

Dimensions

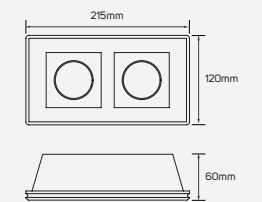

Family Product List

Code No.	Model No.	Cutting Size
631080	ILS120SFW02	Ø125mm
631081	ILS130SFW01	135x135mm
631083	ILS120SFW04	155x155mm
631084	ILS150SFW01	155x155mm
631085	ILS215SFW01	125x220mm
631089	ILS080SFW01	85x85mm

Gypsum Frame

Cloudsoft Glow

Areas of Application



Technical Operating & Electrical Data

Input Voltage & Frequency	AC220-240V, 50/60Hz
Body Material	Gypsum
IP Rating	IP20



Dimensions

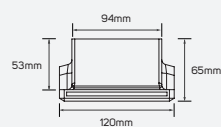

631082



Dimensions

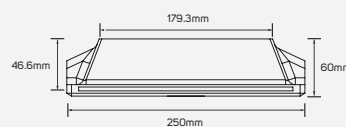

631086



Dimensions

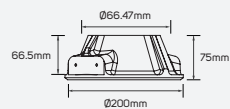

631087



Dimensions

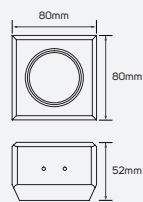

631090



Dimensions

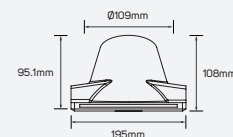

631091

Family Product List

Code No.	Model No.	Cutting Size
631082	ILS120SF03	125x125mm
631086	ILS250SF01	155x255mm
631087	ILS200SF01	Ø205mm
631090	ILS080SF02	85x85mm
631091	ILS195SF01	170x200mm



Surface Mounted Luminaire-Wall

Surface Mounted Luminaire-Wall

Areas of Application

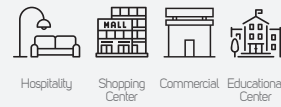

Midsummer Night

Technical Operating & Electrical Data

Input Voltage & Frequency	AC220-240V, 50/60Hz
Body Material	Aluminum
IP Rating	IP20



Dimensions

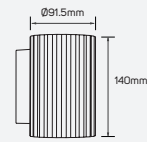

612662 - 612663



Dimensions

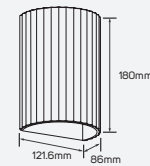

612664 - 612665

Family Product List

Code No.	Model No.	Cap Type
● 612662	ILSSMWF07	G9
● 612663	ILSSMWF07	G9
● 612664	ILSSMWF08	GU10
● 612665	ILSSMWF08	GU10



Dimensions

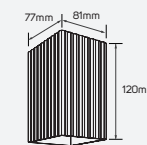

612672 - 612673



Dimensions

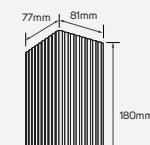

612674 - 612675

Family Product List

Code No.	Model No.	Cap Type
● 612672	ILSSMWF12	GU10
● 612673	ILSSMWF12	GU10
● 612674	ILSSMWF13	GU10
● 612675	ILSSMWF13	GU10

Surface Mounted Luminaire-Wall

Areas of Application



Midsummer Night

Technical Operating & Electrical Data

Input Voltage & Frequency	AC220-240V, 50/60Hz
Body Material	Aluminum
IP Rating	IP20



Dimensions

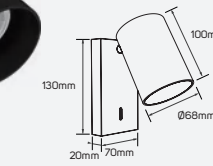

612007-612008



Dimensions

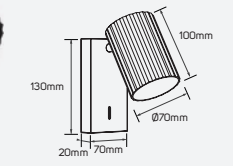

612053-612054

Family Product List

■ Aluminum

Code No.	Model No.	Cap Type	Cutting Size
● 612007	ILSASMWF01	GU10	20x70x130mm
● 612008	ILSASMWF01	GU10	20x70x130mm
● 612053	ILSASMWF02	GU10	20x70x130mm
● 612054	ILSASMWF02	GU10	20x70x130mm

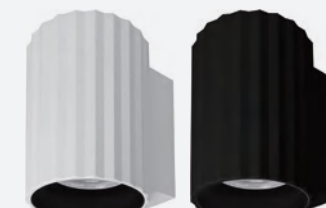

Dimensions

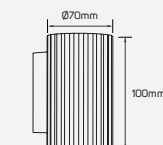

612092-612082



Dimensions

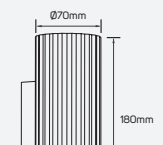

612593-612583

Family Product List

■ Aluminum

Code No.	Model No.	Cap Type	Cutting Size
● 612092	ILSSMWF01	GU10	/
● 612093	ILSSMWF02	GU10	/
● 612582	ILSSMWF01	GU10	100x45x22mm
● 612583	ILSSMWF02	GU10	100x45x22mm

Areas of Application

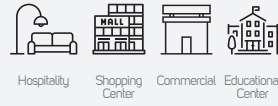

Midsummer Night

Technical Operating & Electrical Data

Input Voltage & Frequency	AC220-240V, 50/60Hz
Body Material	Aluminum
IP Rating	IP20



Dimensions

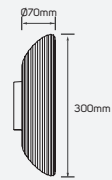

612094 - 612584



Dimensions

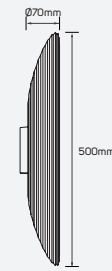

612095 - 612585

Family Product List

■ Aluminum

Code No.	Model No.	Cap Type	Cutting Size
● 612094	ILSSMWF03	GU10	/
● 612095	ILSSMWF04	GU10	/
● 612584	ILSSMWF03	GU10	100x45x22mm
● 612585	ILSSMWF04	GU10	100x45x22mm

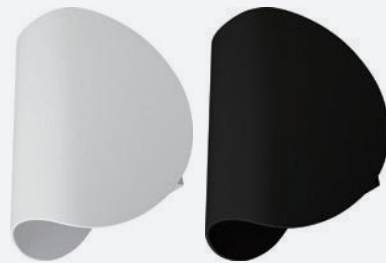

Dimensions

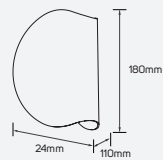

612096 - 612586

Family Product List

■ Aluminum

Code No.	Model No.	Cap Type	Cutting Size
● 612096	ILSSMWF05	GU10	70x100mm
● 612586	ILSSMWF05	GU10	70x100x20mm



Contact Us

global@illuslighting.com

www.illuslighting.com

Find us in KSA,UAE, Oman, Kuwait, Qatar, Egypt, Spain, China.